



Is Now Part of



ON Semiconductor®

To learn more about ON Semiconductor, please visit our website at
www.onsemi.com

ON Semiconductor and the ON Semiconductor logo are trademarks of Semiconductor Components Industries, LLC dba ON Semiconductor or its subsidiaries in the United States and/or other countries. ON Semiconductor owns the rights to a number of patents, trademarks, copyrights, trade secrets, and other intellectual property. A listing of ON Semiconductor's product/patent coverage may be accessed at www.onsemi.com/site/pdf/Patent-Marking.pdf. ON Semiconductor reserves the right to make changes without further notice to any products herein. ON Semiconductor makes no warranty, representation or guarantee regarding the suitability of its products for any particular purpose, nor does ON Semiconductor assume any liability arising out of the application or use of any product or circuit, and specifically disclaims any and all liability, including without limitation special, consequential or incidental damages. Buyer is responsible for its products and applications using ON Semiconductor products, including compliance with all laws, regulations and safety requirements or standards, regardless of any support or applications information provided by ON Semiconductor. "Typical" parameters which may be provided in ON Semiconductor data sheets and/or specifications can and do vary in different applications and actual performance may vary over time. All operating parameters, including "Typicals" must be validated for each customer application by customer's technical experts. ON Semiconductor does not convey any license under its patent rights nor the rights of others. ON Semiconductor products are not designed, intended, or authorized for use as a critical component in life support systems or any FDA Class 3 medical devices or medical devices with a same or similar classification in a foreign jurisdiction or any devices intended for implantation in the human body. Should Buyer purchase or use ON Semiconductor products for any such unintended or unauthorized application, Buyer shall indemnify and hold ON Semiconductor and its officers, employees, subsidiaries, affiliates, and distributors harmless against all claims, costs, damages, and expenses, and reasonable attorney fees arising out of, directly or indirectly, any claim of personal injury or death associated with such unintended or unauthorized use, even if such claim alleges that ON Semiconductor was negligent regarding the design or manufacture of the part. ON Semiconductor is an Equal Opportunity/Affirmative Action Employer. This literature is subject to all applicable copyright laws and is not for resale in any manner.



March 2008

2SC3503/KSC3503 NPN Epitaxial Silicon Transistor

Applications

- Audio, Voltage Amplifier and Current Source
- CRT Display, Video Output
- General Purpose Amplifier

Features

- High Voltage : $V_{CEO} = 300V$
- Low Reverse Transfer Capacitance : $C_{re} = 1.8pF$ at $V_{CB} = 30V$
- Excellent Gain Linearity for low THD
- High Frequency: 150MHz
- Full thermal and electrical Spice models are available
- Complement to 2SA1381/KSA1381.

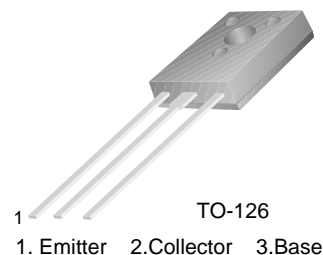

TO-126
1. Emitter 2. Collector 3. Base

Absolute Maximum Ratings* $T_a = 25^\circ C$ unless otherwise noted

Symbol	Parameter	Ratings	Units
BV_{CBO}	Collector-Base Voltage	300	V
BV_{CEO}	Collector-Emitter Voltage	300	V
BV_{EBO}	Emitter-Base Voltage	5	V
I_C	Collector Current(DC)	100	mA
I_{CP}	Collector Current(Pulse)	200	mA
P_C	Total Device Dissipation, $T_C = 25^\circ C$ $T_C = 125^\circ C$	7 1.2	W W
T_J, T_{STG}	Junction and Storage Temperature	- 55 ~ +150	$^\circ C$

* These ratings are limiting values above which the serviceability of any semiconductor device may be impaired.

Thermal Characteristics* $T_a = 25^\circ C$ unless otherwise noted

Symbol	Parameter	Max.	Units
$R_{\theta JC}$	Thermal Resistance, Junction to Case	17.8	$^\circ C/W$

* Device mounted on minimum pad size

h_{FE} Classification

Classification	C	D	E	F
h_{FE}	40 ~ 80	60 ~ 120	100 ~ 200	160 ~ 320

Electrical Characteristics* $T_a=25^\circ\text{C}$ unless otherwise noted

Symbol	Parameter	Test Condition	Min.	Typ.	Max.	Units
BV_{CBO}	Collector-Base Breakdown Voltage	$I_C = 10\mu\text{A}, I_E = 0$	300			V
BV_{CEO}	Collector- Emitter Breakdown Voltage	$I_C = 1\text{mA}, I_B = 0$	300			V
BV_{EBO}	Emitter-Base Breakdown Voltage	$I_E = 10\mu\text{A}, I_C = 0$	5			V
I_{CBO}	Collector Cut-off Current	$V_{CB} = 200\text{V}, I_E = 0$			0.1	μA
I_{EBO}	Emitter Cut-off Current	$V_{EB} = 4\text{V}, I_C = 0$			0.1	μA
h_{FE}	DC Current Gain	$V_{CE} = 10\text{V}, I_C = 10\text{mA}$	40		320	
$V_{CE(sat)}$	Collector-Emitter Saturation Voltage	$I_C = 20\text{mA}, I_B = 2\text{mA}$			0.6	V
$V_{BE(sat)}$	Base-Emitter Saturation Voltage	$I_C = 20\text{mA}, I_B = 2\text{mA}$			1	V
f_T	Current Gain Bandwidth Product	$V_{CE} = 30\text{V}, I_C = 10\text{mA}$		150		MHz
C_{ob}	Output Capacitance	$V_{CB} = 30\text{V}, f = 1\text{MHz}$		2.6		pF
C_{re}	Reverse Transfer Capacitance	$V_{CB} = 30\text{V}, f = 1\text{MHz}$		1.8		pF

* Pulse Test: Pulse Width \leq 300 μs , Duty Cycles \leq 2%**Ordering Information**

Part Number*	Marking	Package	Packing Method	Remarks
2SC3503CSTU	2SC3503C	TO-126	TUBE	hFE1 C grade
2SC3503DSTU	2SC3503D	TO-126	TUBE	hFE1 D grade
2SC3503ESTU	2SC3503E	TO-126	TUBE	hFE1 E grade
2SC3503FSTU	2SC3503F	TO-126	TUBE	hFE1 F grade
KSC3503CSTU	C3503C	TO-126	TUBE	hFE1 C grade
KSC3503DSTU	C3503D	TO-126	TUBE	hFE1 D grade
KSC3503ESTU	C3503E	TO-126	TUBE	hFE1 E grade
KSC3503FSTU	C3503F	TO-126	TUBE	hFE1 F grade

* 1. Affix "-S-" means the standard TO126 Package.(see package dimensions). If the affix is "-STS-" instead of "-S-", that mean the short-lead TO126 package.
 2. Suffix "-TU" means the tube packing. The Suffix "TU" could be replaced to other suffix character as packing method.

Typical Characteristics

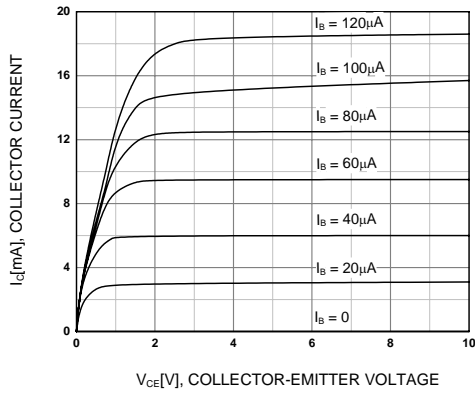

Figure 1. Static Characteristic

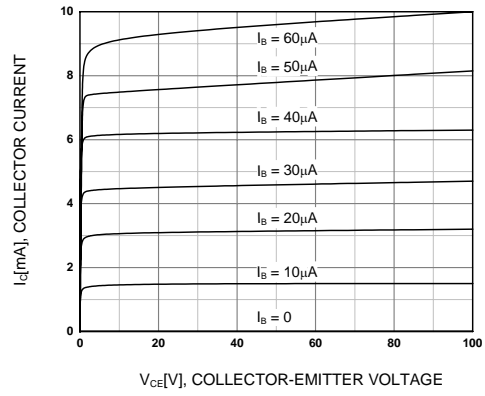

Figure 2. Static Characteristic

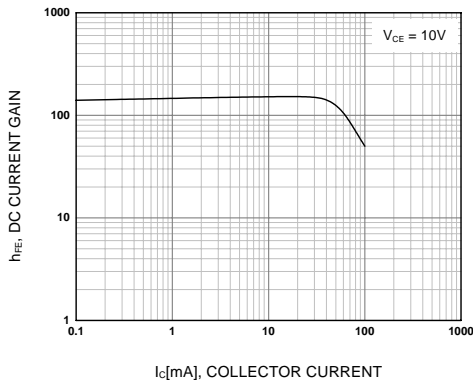

Figure 3. DC current Gain

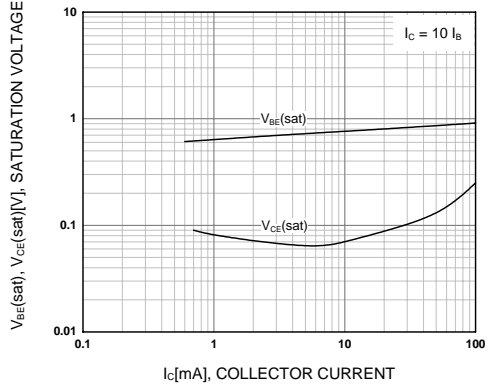

Figure 4. Base-Emitter Saturation Voltage
Collector-Emitter Saturation Voltage

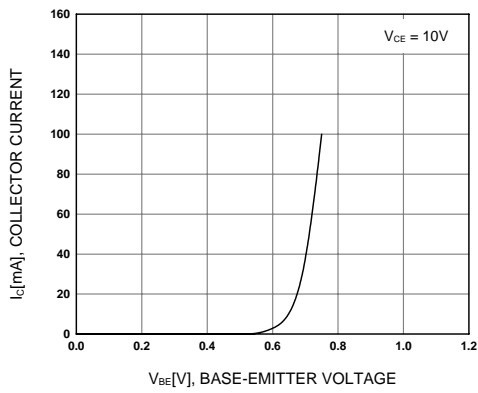

Figure 5. Base-Emitter On Voltage

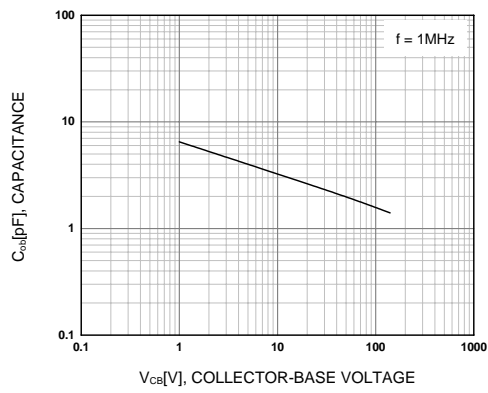

Figure 6. Collector Output Capacitance

Typical Characteristics (Continued)

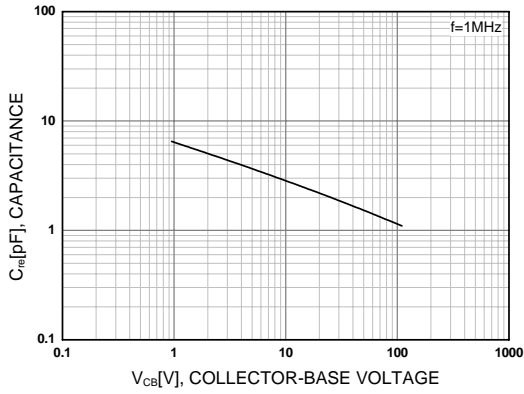

Figure 7. Reverse Transfer Capacitance

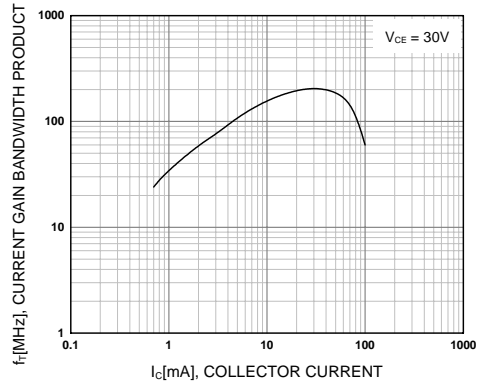

Figure 8. Current Gain Bandwidth Product

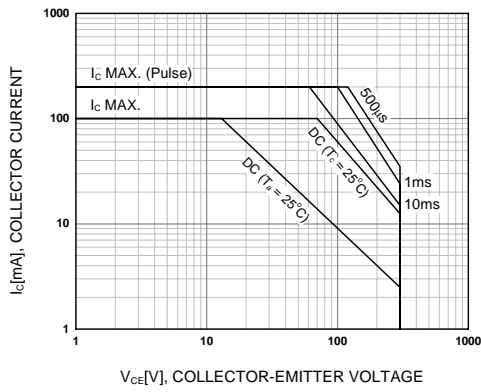

Figure 9. Safe Operating Area

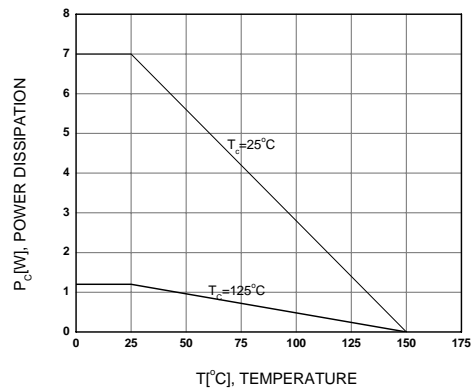
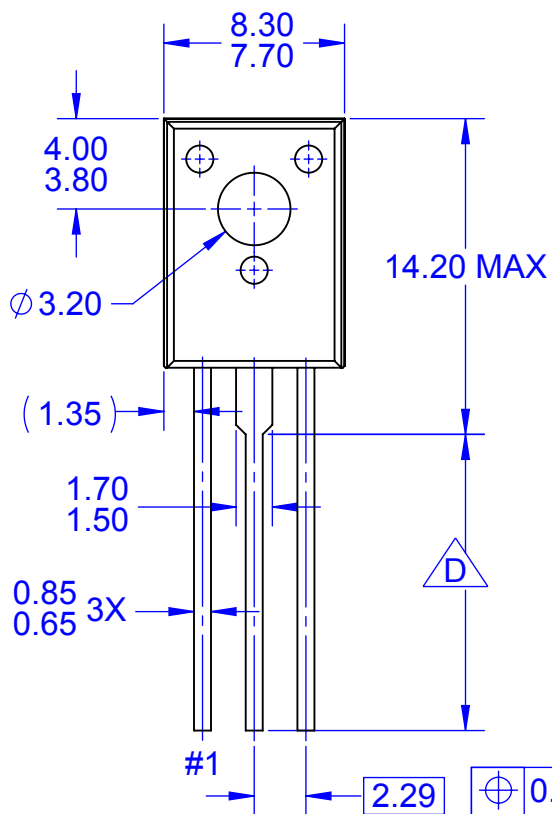
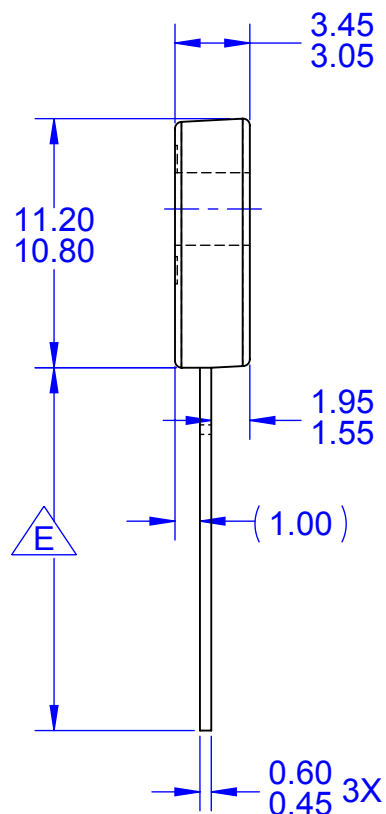

Figure 10. Power Derating



TOP VIEW



SIDE VIEW

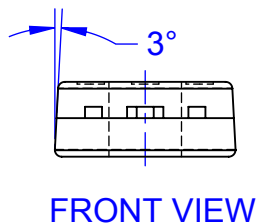

FRONT VIEW

PRODUCTION CODE	TERMINAL LENGTH "D"	TERMINAL LENGTH "E"
TSSTU	3.45 - 4.05	6.45-7.45
TSTU	2.36 - 2.96	5.36-6.36
NONE (STD LENGTH)	12.76 - 13.36	15.76-16.76

NOTES:

- A. NO INDUSTRY STANDARD APPLIES TO THIS PACKAGE
- B. ALL DIMENSIONS ARE IN MILLIMETERS
- C. DIMENSIONS ARE EXCLUSIVE OF BURRS, MOLD FLASH, AND TIE BAR PROTRUSIONS

 FOR TERMINAL LENGTH "D", REFER TO TABLE

 FOR TERMINAL LENGTH "E", REFER TO TABLE

F. DRAWING FILENAME: MKT-TO126AArev2



ON Semiconductor and  are trademarks of Semiconductor Components Industries, LLC dba ON Semiconductor or its subsidiaries in the United States and/or other countries. ON Semiconductor owns the rights to a number of patents, trademarks, copyrights, trade secrets, and other intellectual property. A listing of ON Semiconductor's product/patent coverage may be accessed at www.onsemi.com/site/pdf/Patent-Marking.pdf. ON Semiconductor reserves the right to make changes without further notice to any products herein. ON Semiconductor makes no warranty, representation or guarantee regarding the suitability of its products for any particular purpose, nor does ON Semiconductor assume any liability arising out of the application or use of any product or circuit, and specifically disclaims any and all liability, including without limitation special, consequential or incidental damages. Buyer is responsible for its products and applications using ON Semiconductor products, including compliance with all laws, regulations and safety requirements or standards, regardless of any support or applications information provided by ON Semiconductor. "Typical" parameters which may be provided in ON Semiconductor data sheets and/or specifications can and do vary in different applications and actual performance may vary over time. All operating parameters, including "Typicals" must be validated for each customer application by customer's technical experts. ON Semiconductor does not convey any license under its patent rights nor the rights of others. ON Semiconductor products are not designed, intended, or authorized for use as a critical component in life support systems or any FDA Class 3 medical devices or medical devices with a same or similar classification in a foreign jurisdiction or any devices intended for implantation in the human body. Should Buyer purchase or use ON Semiconductor products for any such unintended or unauthorized application, Buyer shall indemnify and hold ON Semiconductor and its officers, employees, subsidiaries, affiliates, and distributors harmless against all claims, costs, damages, and expenses, and reasonable attorney fees arising out of, directly or indirectly, any claim of personal injury or death associated with such unintended or unauthorized use, even if such claim alleges that ON Semiconductor was negligent regarding the design or manufacture of the part. ON Semiconductor is an Equal Opportunity/Affirmative Action Employer. This literature is subject to all applicable copyright laws and is not for resale in any manner.

PUBLICATION ORDERING INFORMATION

LITERATURE FULFILLMENT:

Literature Distribution Center for ON Semiconductor
19521 E. 32nd Pkwy, Aurora, Colorado 80011 USA
Phone: 303-675-2175 or 800-344-3860 Toll Free USA/Canada
Fax: 303-675-2176 or 800-344-3867 Toll Free USA/Canada
Email: orderlit@onsemi.com

N. American Technical Support: 800-282-9855 Toll Free
USA/Canada
Europe, Middle East and Africa Technical Support:
Phone: 421 33 790 2910
Japan Customer Focus Center
Phone: 81-3-5817-1050

ON Semiconductor Website: www.onsemi.com
Order Literature: <http://www.onsemi.com/orderlit>
For additional information, please contact your local
Sales Representative