

TLV62065-Q1 3-MHz 2-A Step-Down Converter in 2-mm x 2-mm WSON Package

1 Features

- Qualified for Automotive Applications
- AEC-Q100 Test Guidance With the Following Results:
 - Device Temperature Grade 2: -40°C to $+105^{\circ}\text{C}$ Ambient Operating Temperature Range
 - Device HBM ESD Classification Level 2
 - Device CDM ESD Classification Level C4B
- V_{IN} Range from 2.9 to 5.5 V
- Up to 97% Efficiency
- Power-Save Mode or Fixed Frequency PWM Mode
- Output Voltage Accuracy in PWM Mode $\pm 2\%$
- Output Capacitor Discharge Function
- Typical 18- μA Quiescent Current
- 100% Duty Cycle for Lowest Dropout
- Clock Dithering
- Available in a 2-mm x 2-mm x 0.75-mm WSON

2 Applications

- Automotive Infotainment and Cluster
- Advanced Driver Assistance System (ADAS)
- Automotive Display

Typical Application Circuit

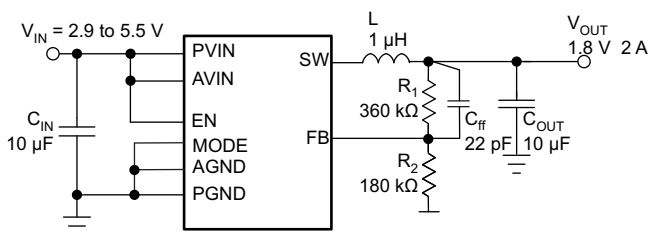

Copyright © 2016, Texas Instruments Incorporated

3 Description

The TLV62065-Q1 device is a highly-efficient synchronous step-down DC-DC converter with adjustable output voltage. The device operates at a switching frequency of 3 MHz and provides up to 2 A of output current.

With an input voltage range of 2.9 to 5.5 V, the device is a perfect fit for power conversion from a 5-V or 3.3-V system supply rail. The TLV62065-Q1 device enters power-save mode operation at light-load currents to maintain high efficiency over the entire load current range. For low-noise applications, the TLV62065-Q1 device can be forced into fixed-frequency PWM mode by pulling the MODE pin high.

In the shutdown mode, the current consumption is reduced to less than 1 μA and an internal circuit discharges the output capacitor.

The TLV62065-Q1 device operates with a 1- μH inductor and 10- μF output capacitor.

The TLV62065-Q1 device is available in a small 2-mm x 2-mm x 0.75-mm 8-pin WSON package.

Device Information⁽¹⁾

PART NUMBER	PACKAGE	BODY SIZE (NOM)
TLV62065-Q1	WSON (8)	2.00 mm x 2.00 mm

(1) For all available packages, see the orderable addendum at the end of the datasheet.

Efficiency vs Load Current

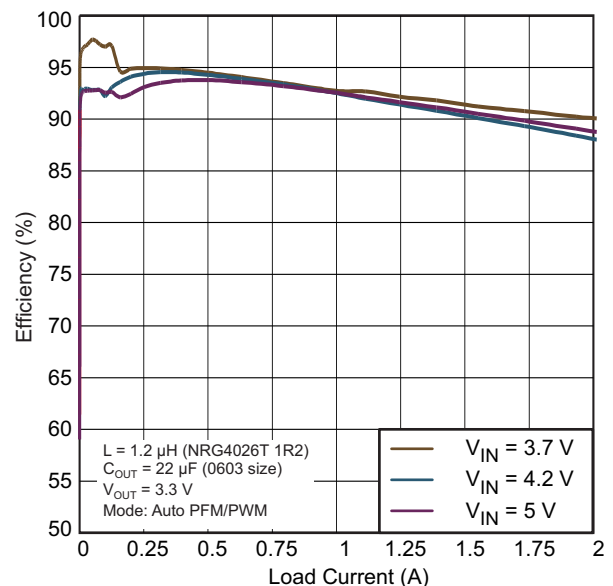

Table of Contents

1 Features 1 2 Applications 1 3 Description 1 4 Revision History 2 5 Pin Configuration and Functions 3 6 Specifications 4 6.1 Absolute Maximum Ratings 4 6.2 ESD Ratings..... 4 6.3 Recommended Operating Conditions..... 4 6.4 Thermal Information 4 6.5 Electrical Characteristics..... 5 6.6 Switching Characteristics 5 6.7 Typical Characteristics 6 7 Detailed Description 11 7.1 Overview 11 7.2 Functional Block Diagram 11 7.3 Feature Description..... 12	7.4 Device Functional Modes..... 13 8 Application and Implementation 15 8.1 Application Information..... 15 8.2 Typical Application 15 9 Power Supply Recommendations 18 10 Layout 18 10.1 Layout Guidelines 18 10.2 Layout Example 19 11 Device and Documentation Support 19 11.1 Documentation Support 19 11.2 Receiving Notification of Documentation Updates 19 11.3 Community Resource..... 19 11.4 Trademarks 19 11.5 Electrostatic Discharge Caution..... 19 11.6 Glossary 20 12 Mechanical, Packaging, and Orderable Information 20
--	---

4 Revision History

NOTE: Page numbers for previous revisions may differ from page numbers in the current version.

Changes from Revision B (June 2015) to Revision C	Page
• Deleted the junction temperature from the <i>Recommended Operating Conditions</i> table	4
• Added a description of the clock dithering feature to the <i>Feature Description</i> section	13
• Added the <i>Receiving Notification of Documentation Updates</i> section	19

Changes from Revision A (March 2012) to Revision B	Page
• Changed the <i>Description</i> section to state that the TLV62065-Q1 device has an adjustable output voltage.	1
• Added the <i>Pin Configuration and Functions</i> section, <i>ESD Ratings</i> table, <i>Feature Description</i> section, <i>Device Functional Modes</i> , <i>Application and Implementation</i> section, <i>Power Supply Recommendations</i> section, <i>Layout</i> section, <i>Device and Documentation Support</i> section, and <i>Mechanical, Packaging, and Orderable Information</i> section	1
• Changed the <i>Thermal Information</i> values	4
• Deleted the <i>Parameter Measurement Information</i> section because the circuit is similar to the application circuit in the <i>Typical Application</i> section	11
• Changed f_c to f_z and R_2 to R_1 in the feed-forward capacitor equations in the <i>Output Voltage Setting</i> section	16
• Deleted the <i>List of Inductors</i> and <i>List of Capacitors</i> tables	16

Changes from Original (January 2012) to Revision A	Page
• Update automotive qualification description and add temperature grade	1
• Update Absolute Maximum Ratings	4
• Update Electrical Characteristics - Shutdown current max rating	5

5 Pin Configuration and Functions

**DSG Package
8-Pin WSON With Exposed Thermal Pad
Top View**

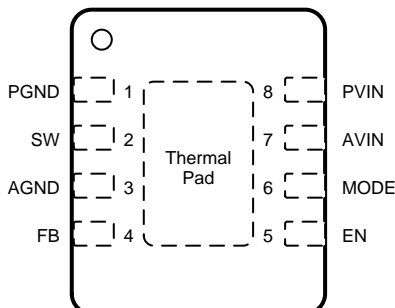

Pin Functions

PIN		TYPE	DESCRIPTION
NAME	NO.		
AGND	3	IN	Analog GND supply pin for the control circuit.
AV _{IN}	7	IN	Analog V _{IN} power supply for the control circuit. This pin must be connected to the PV _{IN} pin and the input capacitor.
EN	5	IN	EN is the enable pin of the device. Pulling this pin low forces the device into shutdown mode. Pulling this pin high enables the device. This pin must be terminated.
FB	4	IN	Feedback pin for the internal regulation loop. Connect the external resistor divider to this pin. In the case of fixed output voltage option, connect this pin directly to the output capacitor.
MODE	6	IN	When the MODE pin is high, the device is forced to operate in fixed-frequency PWM mode. When the MODE pin is low, the device enters the power-save mode with automatic transition from PFM mode to fixed-frequency PWM mode. This pin must be terminated.
PGND	1	PWR	GND supply pin for the output stage
PV _{IN}	8	PWR	V _{IN} power-supply pin for the output stage
SW	2	OUT	SW is the switch pin and is connected to the internal MOSFET switches. Connect the external inductor between this pin and the output capacitor.
Thermal pad		—	For good thermal performance, this pad must be soldered to the land pattern on the PCB. This pad should be used as device GND.

6 Specifications

6.1 Absolute Maximum Ratings

over operating free-air temperature range (unless otherwise noted)⁽¹⁾

		MIN	MAX	UNIT
Voltage ⁽²⁾	AVIN, PVIN	-0.3	7	V
	EN, MODE, FB	-0.3	(VIN + 0.3) < 7	
	SW	-0.3	7	
Current (source)	Peak output	Internally limited		A
Junction temperature, TJ		-40	140	°C
Storage temperature, Tstg		-65	150	°C

- (1) Stresses beyond those listed under *Absolute Maximum Ratings* may cause permanent damage to the device. These are stress ratings only, and functional operation of the device at these or any other conditions beyond those indicated under *Recommended Operating Conditions* is not implied. Exposure to absolute-maximum-rated conditions for extended periods may affect device reliability.
- (2) All voltage values are with respect to the network ground pin.

6.2 ESD Ratings

			VALUE	UNIT	
V(ESD)	Electrostatic discharge	Human body model (HBM), per AEC Q100-002 ⁽¹⁾	±2000	V	
		Charged device model (CDM), per AEC Q100-011	Corner pins (1, 4, 5, and 8)		±750
			Other pins		±500

- (1) AEC Q100-002 indicates HBM stressing is done in accordance with the ANSI/ESDA/JEDEC JS-001 specification.

6.3 Recommended Operating Conditions

		MIN	NOM	MAX	UNIT
AVIN, PVIN	Supply voltage	2.9		5.5	V
	Output current capability			2000	mA
	Output voltage for adjustable voltage	0.8		VIN	V
L	Effective inductance	0.7	1	1.6	μH
COU	Effective output-capacitance	4.5	10	22	μF
TA	Operating ambient temperature ⁽¹⁾	-40		105	°C

- (1) In applications where high power dissipation, poor package thermal resistance, or both are present, the maximum ambient temperature may have to be derated. Maximum ambient temperature (TA(max)) is dependent on the maximum operating junction temperature (TJ(max)), the maximum power dissipation of the device in the application (PD(max)), and the junction-to-ambient thermal resistance of the device or package in the application (RθJA), as given by the following equation: $T_{A(max)} = T_{J(max)} - (R_{\theta JA} \times P_{D(max)})$

6.4 Thermal Information

THERMAL METRIC ⁽¹⁾		TLV62065-Q1	UNIT
		DSG (WSON)	
		8 PINS	
RθJA	Junction-to-ambient thermal resistance	58.1	°C/W
RθJC(top)	Junction-to-case(top) thermal resistance	67.4	°C/W
RθJB	Junction-to-board thermal resistance	29.2	°C/W
ψJT	Junction-to-top characterization parameter	1.1	°C/W
ψJB	Junction-to-board characterization parameter	29.8	°C/W
RθJC(bot)	Junction-to-case(bottom) thermal resistance	7.2	°C/W

- (1) For more information about traditional and new thermal metrics, see the [Semiconductor and IC Package Thermal Metrics](#) application report.

6.5 Electrical Characteristics

Over full operating ambient temperature range, typical values are at $T_A = 25^\circ\text{C}$. Unless otherwise noted, specifications apply for condition $V_{IN} = EN = 3.6\text{ V}$. External components $C_{IN} = 10\ \mu\text{F}$ 0603, $C_{OUT} = 10\ \mu\text{F}$ 0603, $L = 1\ \mu\text{H}$

PARAMETER		TEST CONDITIONS	MIN	TYP	MAX	UNIT
SUPPLY						
V_{IN}	Input voltage range		2.9		5.5	V
I_Q	Operating quiescent current	$I_{OUT} = 0\text{ mA}$, device operating in PFM mode and not device not switching		18		μA
I_{SD}	Shutdown current	$EN = \text{GND}$, current into AVIN and PVIN combined		0.1	5	μA
V_{UVLO}	Undervoltage lockout threshold	Falling	1.73	1.78	1.83	V
		Rising	1.9	1.95	1.99	
ENABLE, MODE						
V_{IH}	High-level input voltage	$2.9\text{ V} \leq V_{IN} \leq 5.5\text{ V}$	1		5.5	V
V_{IL}	Low-level input voltage	$2.9\text{ V} \leq V_{IN} \leq 5.5\text{ V}$	0		0.4	V
I_{IN}	Input bias current	EN, MODE tied to GND or AVIN		0.01	1	μA
POWER SWITCH						
$r_{DS(on)}$	High-side MOSFET on-resistance	$V_{IN} = 3.6\text{ V}$ ⁽¹⁾		120	180	$\text{m}\Omega$
		$V_{IN} = 5\text{ V}$ ⁽¹⁾		95	150	
$r_{DS(on)}$	Low-side MOSFET on-resistance	$V_{IN} = 3.6\text{ V}$ ⁽¹⁾		90	130	$\text{m}\Omega$
		$V_{IN} = 5\text{ V}$ ⁽¹⁾		75	100	
I_{LIMF}	Forward current limit MOSFET high-side and low-side	$3\text{ V} \leq V_{IN} \leq 3.6\text{ V}$	2300	2750		mA
T_{SD}	Thermal shutdown	Increasing junction temperature		150		$^\circ\text{C}$
	Thermal shutdown hysteresis	Decreasing junction temperature		10		
OUTPUT						
V_{ref}	Reference voltage			600		mV
$V_{FB(PWM)}$	Feedback voltage, PWM mode	PWM operation, $\text{MODE} = V_{IN}$, $2.9\text{ V} \leq V_{IN} \leq 5.5\text{ V}$, 0-mA load	-2%	0%	2%	
$V_{FB(PFM)}$	Feedback voltage, PFM mode, voltage positioning	Device in PFM mode, voltage positioning active ⁽²⁾		1%		
V_{FB}	Load regulation			-0.5		%/A
	Line regulation			0		%/V
$R_{(Discharge)}$	Internal discharge resistor	Activated with $EN = \text{GND}$, $2.9\text{ V} \leq V_{IN} \leq 5.5\text{ V}$, $0.8\text{ V} \leq V_{OUT} \leq 3.6\text{ V}$		200		Ω

(1) Maximum value applies for $T_J = 85^\circ\text{C}$.

(2) In PFM mode, the internal reference voltage is set to typ. $1.01 \times V_{ref}$. See the [Application and Implementation](#) section.

6.6 Switching Characteristics

over operating free-air temperature range (unless otherwise noted)

PARAMETER		TEST CONDITIONS	MIN	TYP	MAX	UNIT
OSCILLATOR						
f_{SW}	Oscillator frequency	$2.9\text{ V} \leq V_{IN} \leq 5.5\text{ V}$	2.6	3	3.4	MHz
OUTPUT						
t_{START}	Startup time	Time from active EN to reach 95% of V_{OUT}		500		μs

6.7 Typical Characteristics

Table 1. Table of Graphs

		FIGURE
η Efficiency	Load Current, $V_{OUT} = 1.2$ V, Auto PF//PWM Mode, Linear Scale	Figure 1
	Load Current, $V_{OUT} = 1.8$ V, Auto PF//PWM Mode, Linear Scale	Figure 2
	Load Current, $V_{OUT} = 3.3$ V, PFM/PWM Mode, Linear Scale	Figure 3
	Load Current, $V_{OUT} = 1.8$ V, Auto PFM/PWM Mode vs. Forced PWM Mode, Logarithmic Scale	Figure 4
Output Voltage Accuracy	Load Current, $V_{OUT} = 1.8$ V, Auto PFM/PWM Mode	Figure 5
	Load Current, $V_{OUT} = 1.8$ V, Forced PWM Mode	Figure 6
Shutdown Current	Input Voltage and Ambient Temperature	Figure 7
Quiescent Current	Input Voltage	Figure 8
Oscillator Frequency	Input Voltage	Figure 9
Static Drain-Source On-State Resistance	Input Voltage, Low-Side Switch	Figure 10
	Input Voltage, High-Side Switch	Figure 11
$R_{DISCHARGE}$	Input Voltage vs. V_{OUT}	Figure 12
Typical Operation	PWM Mode, $V_{IN} = 3.6$ V, $V_{OUT} = 1.8$ V, 500 mA, $L = 1.2$ μ H, $C_{OUT} = 10$ μ F	Figure 13
	PFM Mode, $V_{IN} = 3.6$ V, $V_{OUT} = 1.8$ V, 20 mA, $L = 1.2$ μ H, $C_{OUT} = 10$ μ F	Figure 14
Load Transient	PWM Mode, $V_{IN} = 3.6$ V, $V_{OUT} = 1.2$ V, 0.2 mA to 1 A	Figure 15
	PFM Mode, $V_{IN} = 3.6$ V, $V_{OUT} = 1.2$ V, 20 mA to 250 mA	Figure 16
	$V_{IN} = 3.6$ V, $V_{OUT} = 1.8$ V, 200 mA to 1500 mA	Figure 17
Line Transient	PWM Mode, $V_{IN} = 3.6$ V to 4.2 V, $V_{OUT} = 1.8$ V, 500 mA	Figure 18
	PFM Mode, $V_{IN} = 3.6$ V to 4.2 V, $V_{OUT} = 1.8$ V, 500 mA	Figure 19
Startup into Load	$V_{IN} = 3.6$ V, $V_{OUT} = 1.8$ V, Load = 2.2- Ω	Figure 20
Output Discharge	$V_{IN} = 3.6$ V, $V_{OUT} = 1.8$ V, No Load	Figure 21

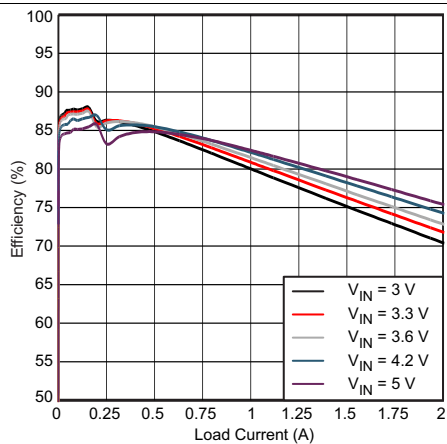

$V_{OUT} = 1.2$ V Linear Scale
 $L = 1.2$ μ H (NRG4026T 1R2) $C_{OUT} = 10$ μ F (0603 size)

**Figure 1. Efficiency vs Load Current
 Auto PFM and PWM MODE**

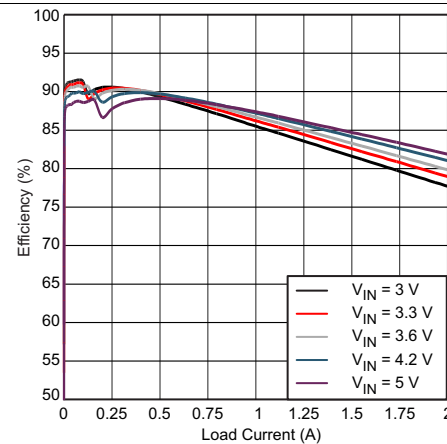

$V_{OUT} = 1.8$ V Linear Scale
 $L = 1.2$ μ H (NRG4026T 1R2) $C_{OUT} = 10$ μ F (0603 size)

**Figure 2. Efficiency vs Load Current
 Auto PFM and PWM MODE**

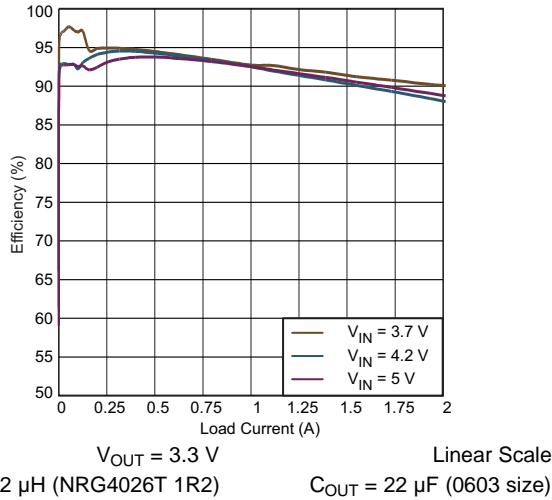

Figure 3. Efficiency vs Load Current
Auto PFM and PWM MODE

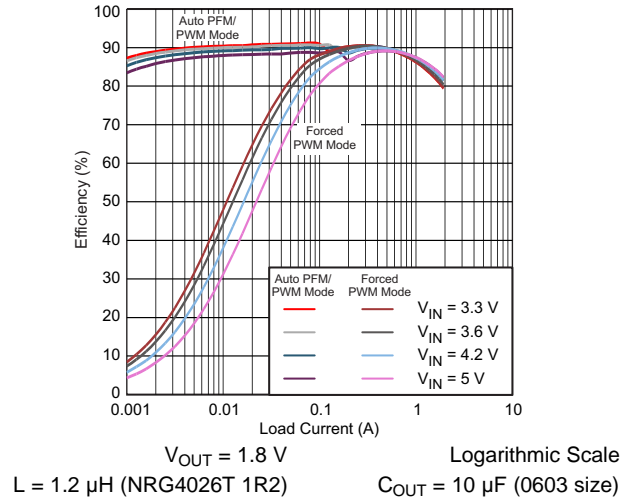

Figure 4. Efficiency vs Load Current
Auto PFM and PWM Mode vs. Forced PWM Mode

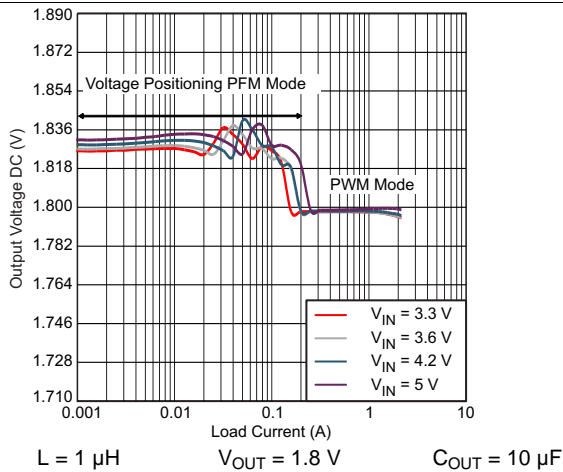

Figure 5. Output Voltage Accuracy vs Load Current
Auto PFM and PWM MODE

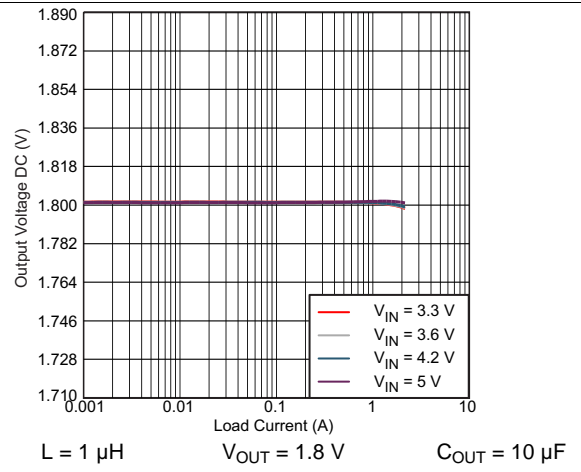

Figure 6. Output Voltage Accuracy vs Load Current
Forced PWM MODE

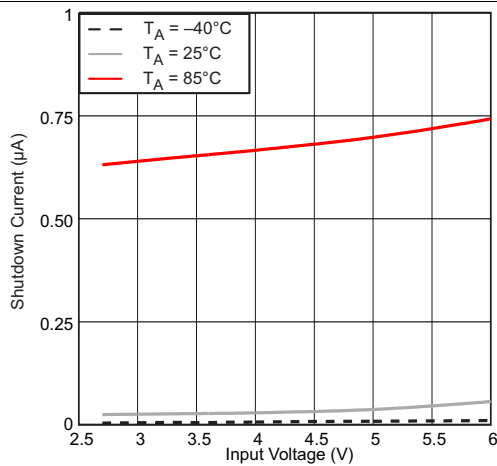

Figure 7. Shutdown Current vs Input Voltage and Ambient Temperature

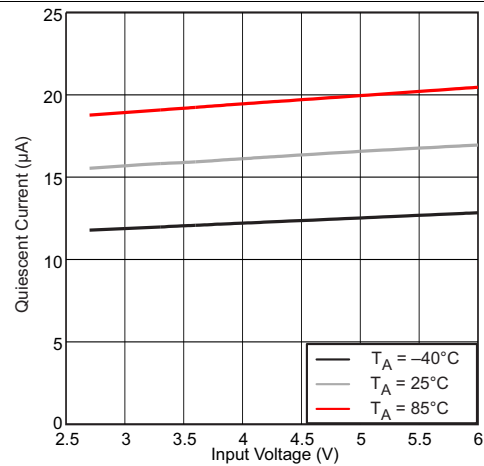

Figure 8. Quiescent Current vs Input Voltage

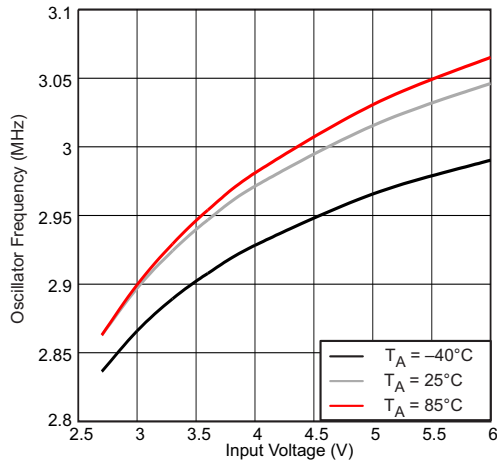
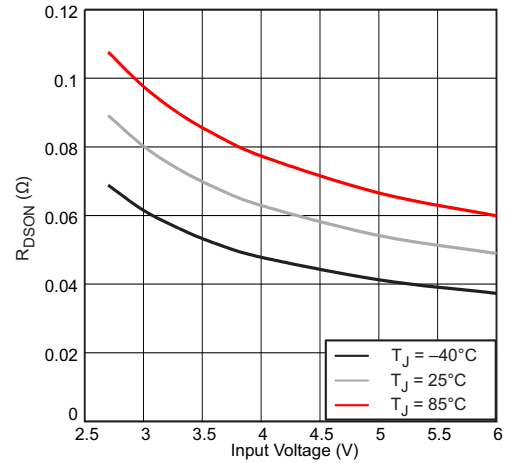
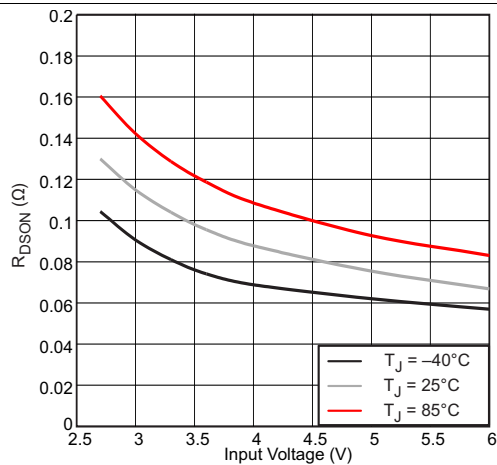

Figure 9. Oscillator Frequency vs Input Voltage



Low-Side Switch

Figure 10. Static Drain-Source On-State Resistance vs Input Voltage



High-Side Switch

Figure 11. Static Drain-Source On-State Resistance vs Input Voltage

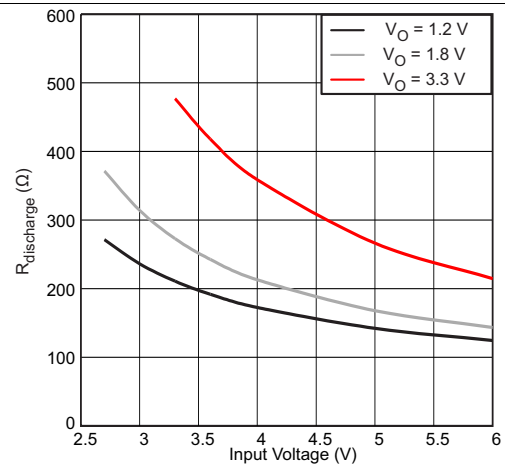

Figure 12. R_DISCHARGE vs Input Voltage

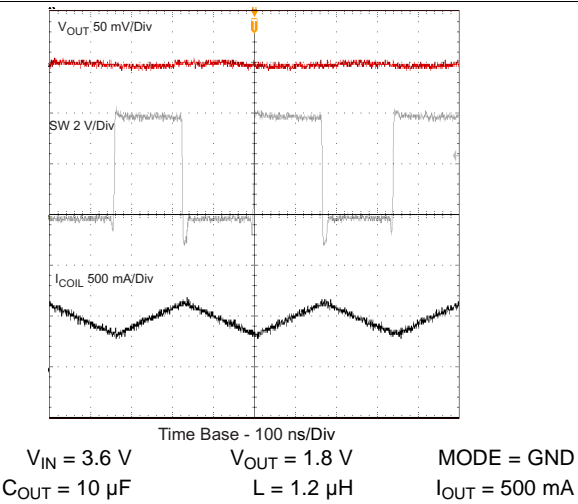

Figure 13. Typical Operation (PWM Mode)

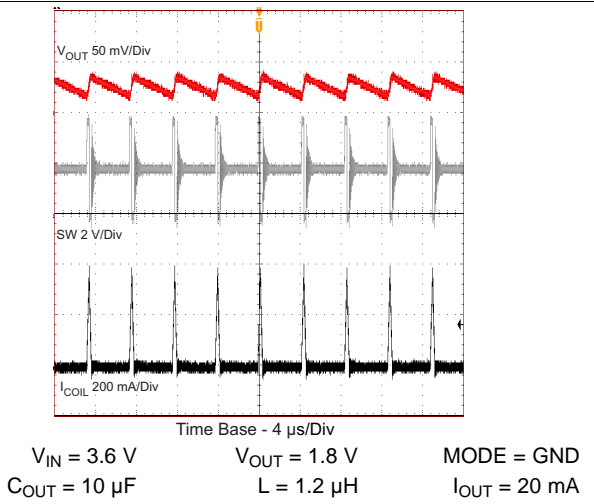
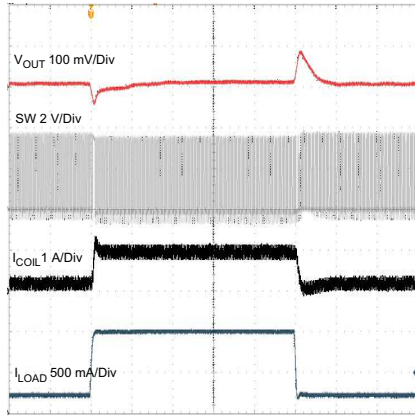
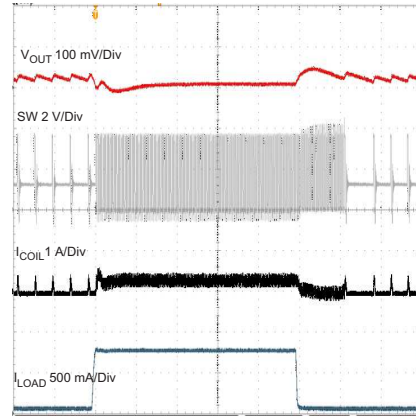

Figure 14. Typical Operation (PFM Mode)



$V_{IN} = 3.6\text{ V}$ $V_{OUT} = 1.2\text{ V}$ $I_{OUT} = 0.2\text{ to }1\text{ A}$

**Figure 15. Load Transient Response, MODE = V_{IN}
PWM Mode 0.2 A To 1 A**



$V_{IN} = 3.6\text{ V}$ $V_{OUT} = 1.2\text{ V}$ $I_{OUT} = 20\text{ to }250\text{ mA}$

**Figure 16. Load Transient
PFM Mode 20 mA to 250 mA**

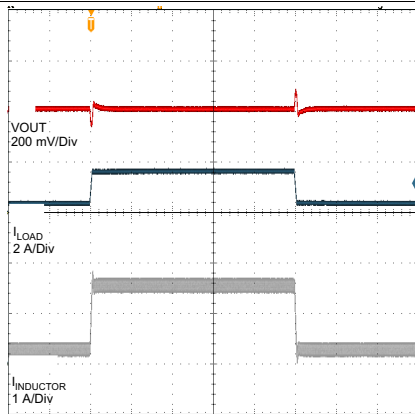

$V_{IN} = 3.6\text{ V}$ $V_{OUT} = 1.8\text{ V}$ $L = 1.2\text{ }\mu\text{H}$
 $C_{OUT} = 10\text{ }\mu\text{F}$ $I_{OUT} = 200\text{ to }1500\text{ mA}$

**Figure 17. Load Transient Response
200 mA To 1500 mA**

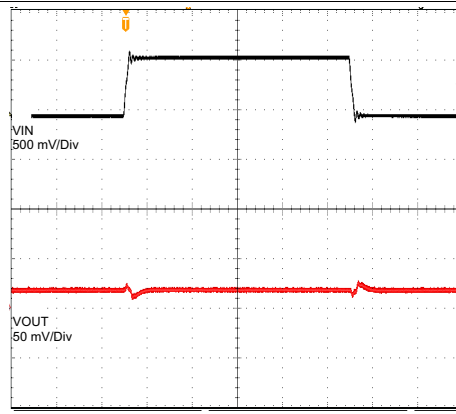

$V_{IN} = 3.6\text{ to }4.2\text{ V}$ $V_{OUT} = 1.8\text{ V}$ $I_{OUT} = 500\text{ mA}$
 $C_{OUT} = 10\text{ }\mu\text{F}$ $L = 1.2\text{ }\mu\text{H}$

Figure 18. Line Transient Response PWM Mode

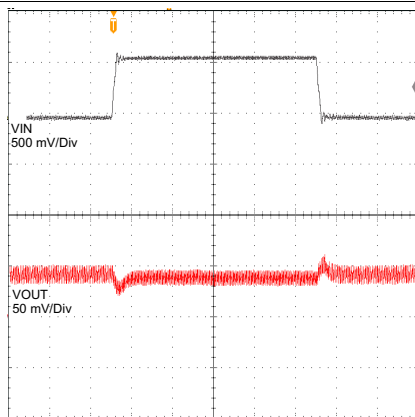

$V_{IN} = 3.6\text{ to }4.2\text{ V}$ $V_{OUT} = 1.8\text{ V}$ $I_{OUT} = 500\text{ mA}$
 $C_{OUT} = 10\text{ }\mu\text{F}$ $L = 1.2\text{ }\mu\text{H}$

Figure 19. Line Transient PFM Mode

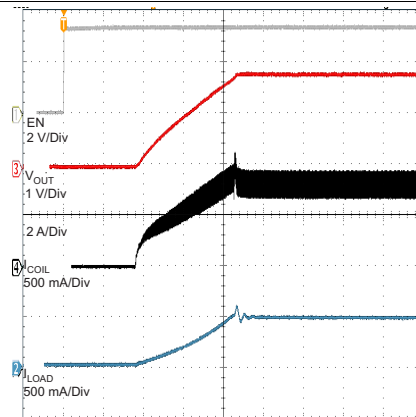

$V_{IN} = 3.6\text{ V}$ $V_{OUT} = 1.8\text{ V}$ Load = $2.2\text{ }\Omega$
 $C_{OUT} = 10\text{ }\mu\text{F}$ $L = 1.2\text{ }\mu\text{H}$

Figure 20. Startup Into Load

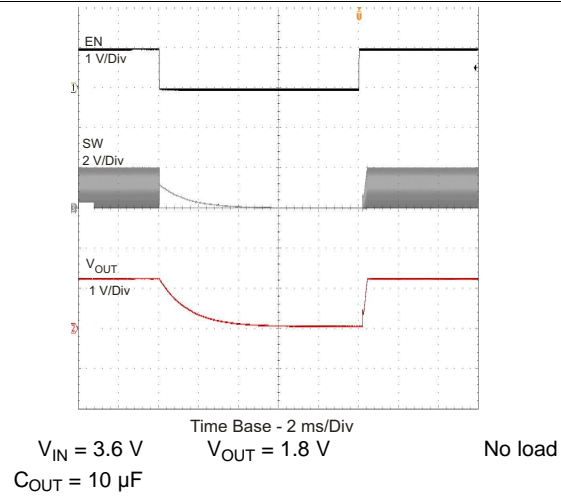

Figure 21. Output Discharge

7 Detailed Description

7.1 Overview

The TLV62065-Q1 step-down converter operates with a typical 3-MHz fixed-frequency pulse-width modulation (PWM) at moderate to heavy load currents. At light load currents, the converter can automatically enter power-save mode, and then operates in pulse-frequency mode (PFM).

During PWM operation, the converter uses a unique fast-response voltage-mode controller scheme with input voltage feed-forward to achieve good line and load regulation, allowing the use of small ceramic input and output capacitors. At the beginning of each clock cycle, the high-side MOSFET switch is turned on. The current now flows from the input capacitor through the high-side MOSFET switch through the inductor to the output capacitor and load. During this phase, the current ramps up until the PWM comparator trips and the control logic turns off the switch. The current-limit comparator also turns off the switch in case the current-limit of the high-side MOSFET switch is exceeded. After a dead time preventing shoot-through current, the low-side MOSFET rectifier is turned on and the inductor current ramps down. The current now flows from the inductor to the output capacitor and to the load. The current returns back to the inductor through the low-side MOSFET rectifier.

The next cycle is initiated by the clock signal again turning off the low-side MOSFET rectifier and turning on the high-side MOSFET switch.

7.2 Functional Block Diagram

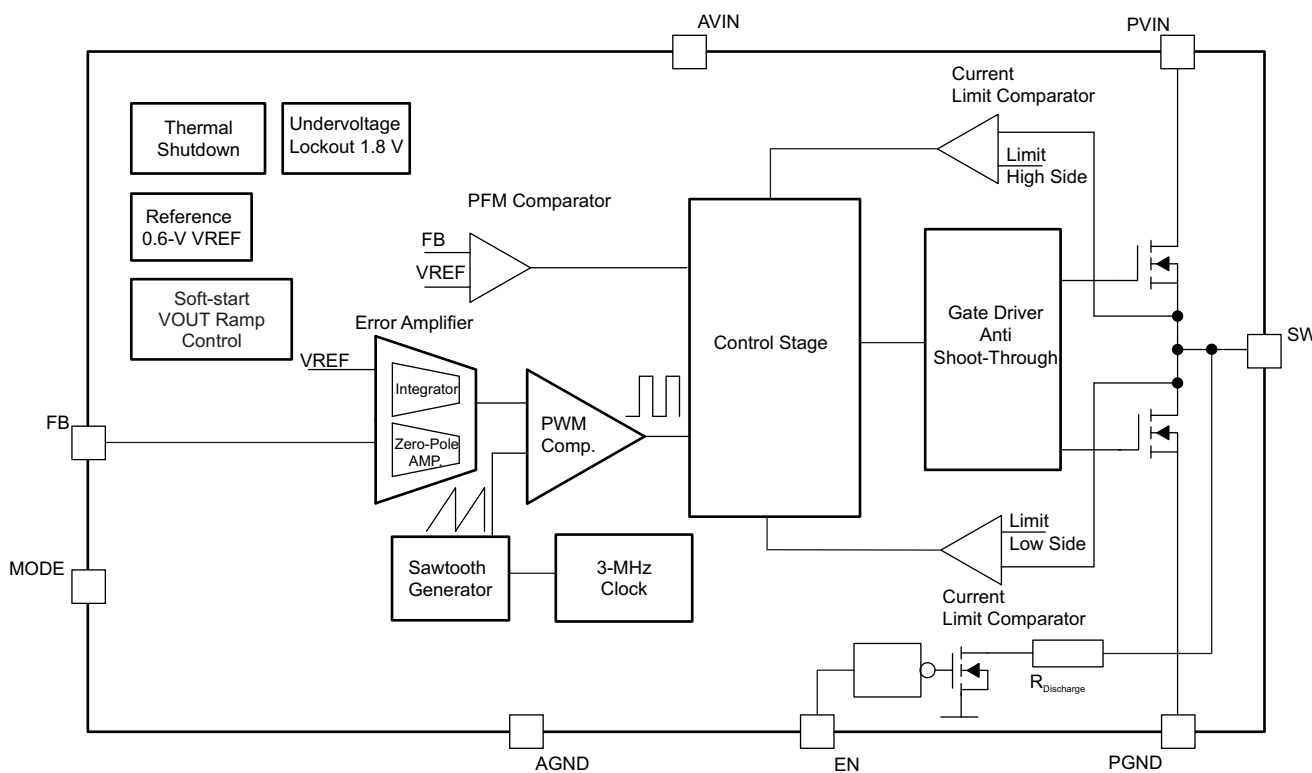

Copyright © 2016, Texas Instruments Incorporated

7.3 Feature Description

7.3.1 Enable

The device is enabled by setting the EN pin high. At first, the internal reference is activated and the internal analog circuits are settled. Afterwards, the soft start is activated and the output voltage is ramped up. The output voltage reaches 95% of the nominal value within t_{START} of typically 500 μs after the device has been enabled. The EN input can be used to control power sequencing in a system with various DC-DC converters. To drive the EN pin high and get a sequencing of supply rails, connect the EN pin to the output of another converter. With EN = GND, the device enters shutdown mode. In this mode, all circuits are disabled and the SW pin is connected to PGND through an internal resistor to discharge the output.

7.3.2 Mode Selection

The MODE pin allows mode selection between forced PWM mode and power-save mode.

Connecting this pin to GND enables the power-save mode with automatic transition between PWM and PFM mode. Pulling the MODE pin high forces the converter to operate in fixed-frequency PWM mode even at light load currents which allows simple filtering of the switching frequency for noise-sensitive applications. In this mode, the efficiency is lower compared to the power-save mode during light loads.

The condition of the MODE pin can be changed during operation and allows efficient power management by adjusting the operation mode of the converter to the specific system requirements.

7.3.3 Soft-Start Functionality

The TLV62065-Q1 device has an internal soft-start circuit that controls the ramp-up of the output voltage. When the converter is enabled and the input voltage is above the undervoltage lockout threshold, V_{UVLO} , the output voltage ramps up from 5% to 95% of the nominal value within a t_{Ramp} of 250 μs (typical).

This ramping limits the inrush current in the converter during startup and prevents possible input-voltage drops when a battery or high-impedance power source is used.

During soft start, the switch current limit is reduced to 1/3 of the nominal value, I_{LIMF} , until the output voltage reaches 1/3 of the nominal value. When the output voltage trips this threshold, the device operates with the nominal current-limit, I_{LIMF} .

7.3.4 Internal Current-Limit and Foldback Current-Limit For Short-Circuit Protection

During normal operation, the high-side and low-side MOSFET switches are protected by the current limits, I_{LIMF} . When the high-side MOSFET switch reaches the current limit, it is turned off and the low-side MOSFET switch is turned on. The high-side MOSFET switch can only turn on again when the current in the low-side MOSFET switch decreases below the current-limit, I_{LIMF} . The device is capable of providing peak inductor currents up to the internal-current limit I_{LIMF} .

As soon as the switch-current limits are hit and the output voltage falls below 1/3 of the nominal output voltage because of an overload or short-circuit condition, the foldback current limit is enabled. In this case, the switch-current limit is reduced to 1/3 of the nominal value, I_{LIMF} .

Because the short-circuit protection is enabled during startup, the device does not deliver more than 1/3 of the nominal current-limit, I_{LIMF} , until the output voltage exceeds 1/3 of the nominal output voltage. This must be considered when a load which acts as a current sink is connected to the output of the converter.

Feature Description (continued)

7.3.5 100% Duty Cycle Low-Dropout Operation

The device begins to enter 100% duty cycle mode as the input voltage comes close to the nominal output voltage. In order to maintain the output voltage, the high-side MOSFET switch is turned on 100% for one or more cycles.

With further decreasing V_{IN} , the high-side MOSFET switch is turned on completely. In this case, the converter offers a low input-to-output voltage differential. This differential voltage is particularly useful in battery-powered applications to achieve longest operation time by taking full advantage of the whole battery voltage range.

The minimum input voltage to maintain regulation depends on the load current and output voltage, and is calculated using [Equation 1](#).

$$V_{INmin} = V_{Omax} + I_{Omax} \times (R_{DS(on)max} + R_L)$$

where

- I_{Omax} = maximum output current
- $R_{DS(on)max}$ = maximum P-channel switch $R_{DS(on)}$
- R_L = DC resistance of the inductor
- V_{Omax} = nominal output voltage plus maximum output voltage tolerance (1)

7.3.6 Clock Dithering

To reduce the noise level of switch-frequency harmonics in the higher RF bands, the TLV62065-Q1 device has a built-in clock-dithering circuit. The oscillator frequency is slightly modulated with a sub clock which causes a clock dither of ± 3 ns (typical).

7.3.7 Undervoltage Lockout

The undervoltage lockout (UVLO) circuit prevents the device from malfunctioning at low input voltages and from excessive discharge of the battery. The UVLO circuit disables the output stage of the converter once the falling V_{IN} trips the undervoltage lockout threshold V_{UVLO} . The undervoltage lockout threshold V_{UVLO} for falling V_{IN} is typically 1.78 V. The device begins operation when the rising V_{IN} trips the undervoltage lockout threshold V_{UVLO} again at 1.95 V (typical).

7.3.8 Output Capacitor Discharge

With $EN = GND$, the device enters shutdown mode and disables all internal circuits. An internal resistor connects the SW pin is to PGND to discharge the output capacitor. This feature ensures startup with a discharged output capacitor when the converter is enabled again and prevents a *floating* charge on the output capacitor. The output voltage ramps up monotonic, starting from 0 V.

7.3.9 Thermal Shutdown

As soon as the junction temperature, T_J , exceeds 150°C (typical) the device goes into thermal shutdown. In this mode, the high-side and low-side MOSFETs are turned off. The device continues operation with a soft-start when the junction temperature falls below the thermal shutdown hysteresis.

7.4 Device Functional Modes

7.4.1 Power Save Mode

Pulling the TLV62065-Q1 MODE pin low enables power-save mode. If the load current decreases, the converter enters power-save mode operation automatically. In power-save mode, the converter skips switching and operates with reduced frequency in the PFM mode with a minimum quiescent current to maintain high efficiency. The converter positions the output voltage 1% (typical) above the nominal output voltage. This voltage-positioning feature minimizes voltage drops caused by a sudden load step.

The transition from PWM mode to PFM mode occurs when the inductor current in the low-side MOSFET switch becomes zero, which indicates discontinuous conduction mode.

Device Functional Modes (continued)

In power-save mode, a PFM comparator monitors the output voltage. As the output voltage falls below the PFM comparator threshold of $V_{OUTnominal} + 1\%$, the device begins a PFM current pulse. For this pulse, the high-side MOSFET switch turns on and the inductor current ramps up. After the on-time expires, the switch is turned off and the low-side MOSFET switch is turned on until the inductor current becomes zero.

The converter effectively delivers a current to the output capacitor and the load. If the load is below the delivered current, the output voltage rises. If the output voltage is equal to or higher than the PFM comparator threshold, the device stops switching and enters a sleep mode with 18- μ A current consumption (typical).

In case the output voltage is still below the PFM comparator threshold, further PFM current pulses are generated until the PFM comparator threshold is reached. The converter begins switching again when the output voltage drops below the PFM comparator threshold because of the load current.

The device leaves PFM mode and goes to PWM mode in case the output current can no longer be supported in PFM mode.

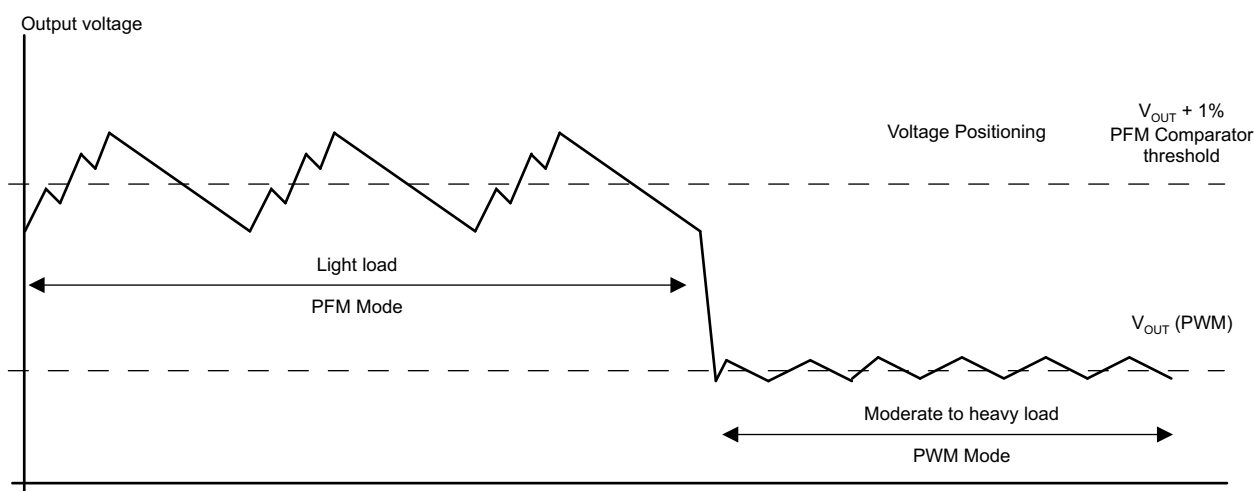

Figure 22. Power Save Mode Operation With Automatic Mode Transition

8 Application and Implementation

NOTE

Information in the following applications sections is not part of the TI component specification, and TI does not warrant its accuracy or completeness. TI's customers are responsible for determining suitability of components for their purposes. Customers should validate and test their design implementation to confirm system functionality.

8.1 Application Information

The TLV62065-Q1 device is a highly efficient, synchronous step-down, DC-DC converter with an adjustable output voltage and an output current of up to 2 A. The device can be used in buck converter applications with an input range from 2.9 to 5.5 V.

8.2 Typical Application

The typical application circuit (see [Figure 23](#)) is optimized for an output voltage of 1.8 V and a load current of 2 A maximum for an input voltage from 2.9 to 5.5 V.

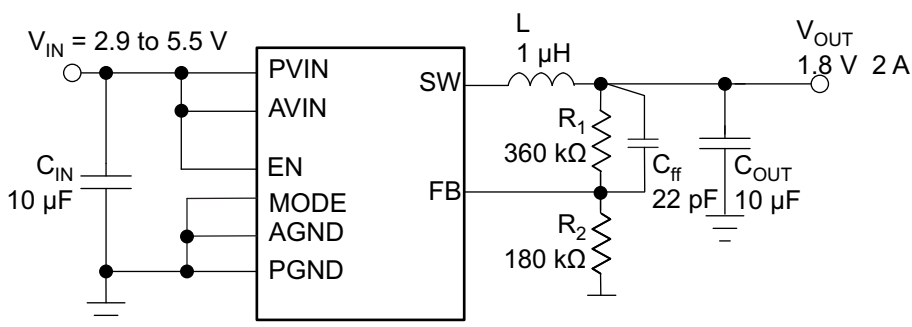

Copyright © 2016, Texas Instruments Incorporated

Figure 23. TLV62065-Q1 1.8-V Adjustable Output Voltage Configuration

8.2.1 Design Requirements

The input voltage for this device must be from 2.9 V to 5.5 V. The output voltage must be set using an external voltage divider. The internal compensation network of the device is optimized for an LC output filter that is composed of a 1-µH inductor and a 10-µF ceramic capacitor with a suitable external feed-forward capacitor calculated based on the voltage divider resistor. The [Recommended Operating Conditions](#) table specifies the allowed range for input voltages, output voltages, output current, inductance, and capacitance. The values listed in this table must be followed when designing the regulator. Low-ESR ceramic capacitors should be used at the input and output for better filtering and ripple performance. The [Detailed Design Procedure](#) section provides the necessary equations and guidelines for selecting external components for this regulator.

8.2.2 Detailed Design Procedure

8.2.2.1 Output Voltage Setting

Use [Equation 2](#) to calculate the output voltage.

$$V_{OUT} = V_{REF} \times \left(1 + \frac{R_1}{R_2} \right)$$

where

- V_{REF} is the internal reference voltage at 0.6 V (typical).
- R_1 is the feedback divider resistor connected between the V_{OUT} and FB pins.
- R_2 is the feedback divider resistor connected between the FB pin and GND.

(2)

Typical Application (continued)

To minimize the current through the feedback divider network, R_2 , should be within the range of 120 k Ω to 360 k Ω . To keep the network robust against noise the sum of R_1 and R_2 should not exceed approximately 1 M Ω . However, lower resistor values can be used. An external feed-forward capacitor, C_{ff} , is required for optimum regulation performance. R_1 and C_{ff} place a zero in the loop. Use Equation 4 to calculate the value of C_{ff} .

$$f_z = \frac{1}{2 \times \pi \times R_1 \times C_{ff}} = 25 \text{ kHz} \quad (3)$$

$$C_{ff} = \frac{1}{2 \times \pi \times R_1 \times 25 \text{ kHz}} \quad (4)$$

8.2.2.2 Output Filter Design (inductor And Output Capacitor)

The internal compensation network of the TLV62065-Q1 device is optimized for an LC output filter with a corner frequency that is calculated with Equation 5

$$f_c = \frac{1}{2 \times \pi \times \sqrt{(1 \mu\text{H} \times 10 \mu\text{F})}} = 50 \text{ kHz} \quad (5)$$

The device operates with nominal inductors of 1 μH to 1.2 μH and with 10 μF to 22 μF small X5R and X7R ceramic capacitors. The device is optimized for a 1- μH inductor and 10- μF output capacitor.

8.2.2.2.1 Inductor Selection

The inductor value has a direct effect on the ripple current. The selected inductor must be rated for the DC resistance and saturation current. The inductor ripple current (ΔI_L) decreases with higher inductance and increases with higher V_{IN} or V_{OUT} .

Use Equation 6 to calculate the maximum inductor current in PWM mode under static load conditions. The saturation current of the inductor should be rated higher than the maximum inductor current as calculated with Equation 7. This value is recommended because during heavy load transients the inductor current rises above the calculated value.

$$\Delta I_L = V_{OUT} \times \frac{1 - \frac{V_{OUT}}{V_{IN}}}{L \times f}$$

where

- ΔI_L = Peak-to-peak inductor ripple current
- L = Inductor value
- f = Switching frequency (3 MHz typical)

(6)

$$I_{Lmax} = I_{OUTmax} + \frac{\Delta I_L}{2}$$

where

- I_{Lmax} = Maximum inductor current

(7)

A more conservative approach is to select the inductor current rating just for the switch-current limit I_{LIMF} of the converter.

The total losses of the coil have a strong impact on the efficiency of the DC-DC conversion and consist of both the losses in the DC resistance $R_{(DC)}$ and the following frequency-dependent components:

- The losses in the core material (magnetic hysteresis loss, especially at high switching frequencies)
- Additional losses in the conductor from the skin effect (current displacement at high frequencies)
- Magnetic field losses of the neighboring windings (proximity effect)
- Radiation losses

Typical Application (continued)

8.2.2.2.2 Output Capacitor Selection

The advanced fast-response voltage-mode control scheme of the TLV62065-Q1 device allows the use of tiny ceramic capacitors. Ceramic capacitors with low ESR values provide the lowest output-voltage ripple and are recommended. The output capacitor requires either an X7R or X5R dielectric. Y5V- and Z5U-dielectric capacitors, aside from a wide variation in capacitance over temperature, become resistive at high frequencies and may not be used. For most applications, a nominal 10- μ F or 22- μ F capacitor is suitable. In small ceramic capacitors, the DC-bias effect decreases the effective capacitance. Therefore a 22- μ F capacitor can be used for output voltages higher than 2 V.

In case additional ceramic capacitors in the supplied system are connected to the output of the DC-DC converter, the output capacitor C_{OUT} must be decreased in order not to exceed the recommended effective capacitance range. In this case, a loop-stability analysis must be performed as described in the [Checking Loop Stability](#) section.

Use [Equation 8](#) to calculate the RMS ripple current at the nominal load current and while the device is in PWM mode.

$$I_{RMS_{Cout}} = V_{OUT} \times \frac{1 - \frac{V_{OUT}}{V_{IN}}}{L \times f} \times \frac{1}{2 \times \sqrt{3}} \quad (8)$$

8.2.2.2.3 Input Capacitor Selection

Because of the nature of the buck converter having a pulsating input current, a low-ESR input capacitor is required for best input voltage filtering and minimizing interference with other circuits caused by high input voltage spikes. For most applications a 10- μ F ceramic capacitor is recommended. The input capacitor can be increased without any limit for better input voltage filtering.

Take care when using only small ceramic input capacitors. When a ceramic capacitor is used at the input and the power is being supplied through long wires, such as from a wall adapter, a load step at the output or V_{IN} step on the input can induce ringing at the V_{IN} pin. This ringing can couple to the output and be mistaken as loop instability, or could even damage the part by exceeding the maximum ratings.

8.2.2.3 Checking Loop Stability

The first step of circuit and stability evaluation is to look at the following signals from a steady-state perspective:

- Switching node, SW
- Inductor current, I_L
- Output ripple voltage, $V_{OUT(AC)}$

These signals are the basic signals that must be measured when evaluating a switching converter. When the switching waveform shows large duty cycle jitter, or the output voltage or inductor current shows oscillations, the regulation loop may be unstable. This instability is often a result of board layout, wrong L-C output filter combinations, or both. As a next step in the evaluation of the regulation loop, the transient response of the load is tested. During the time between the application of the load transient and the turnon of the P-channel MOSFET, the output capacitor must supply all of the current required by the load. V_{OUT} immediately shifts by an amount equal to $\Delta I_{(LOAD)} \times ESR$, where ESR is the effective series resistance of C_{OUT} . $\Delta I_{(LOAD)}$ begins to charge or discharge C_O , generating a feedback error signal used by the regulator to return V_{OUT} to its steady-state value. The results are most easily interpreted when the device operates in PWM mode at medium-to-high load currents.

During this recovery time, V_{OUT} can be monitored for settling time, overshoot, or ringing; that helps evaluate stability of the converter. Without any ringing, the loop has usually more than 45° of phase margin.

Typical Application (continued)

8.2.3 Application Curves

For the application curves, see the graphs listed in [Table 2](#).

Table 2. Table of Graphs

		FIGURE
Output Voltage Accuracy	Load Current, $V_{OUT} = 1.8\text{ V}$, Auto PFM/PWM Mode	Figure 5
	Load Current, $V_{OUT} = 1.8\text{ V}$, Forced PWM Mode	Figure 6

9 Power Supply Recommendations

The TLV62065-Q1 device is designed to operate from an input voltage up to 5.5 V. For the input pins (PVIN and AVIN), a small ceramic capacitor with a typical value of 10 μF is recommended for most applications. Capacitance derating for aging, temperature, and DC bias must be taken into account while determining the capacitor value.

10 Layout

10.1 Layout Guidelines

As for all switching power supplies, the layout is an important step in the design. Proper function of the device demands careful attention to PCB layout. Care must be taken in board layout to get the specified performance. If the layout is not carefully done, the regulator could show poor line regulation, load regulation or both and may have stability issues as well as EMI and thermal problems. Providing a low-inductance, low-impedance ground path is critical. Therefore, use wide and short traces for the main current paths. The input capacitor as well as the inductor and output capacitor should be placed as close as possible to the IC pins.

Large parasitic inductance in ground path or large parasitic inductance between input capacitor and VIN pin can cause significant overshoot or undershoot voltage on SW pin exceeding the specifications in the [Absolute Maximum Ratings](#) table.

Connect the AGND and PGND pins of the device to the thermal pad land of the PCB and use this pad as a star point. To minimize the effects of ground noise use a common power node (PGND), and a different node (AGND) for the signal. The FB divider network should be connected directly to the output capacitor and the FB line must be routed away from noisy components and traces (for example, the SW line).

Because of the small package of this converter and the overall small solution size, the thermal performance of the PCB layout is important. For good thermal performance, PCB design of at least four layers is recommended. The thermal pad of the IC must be soldered on the thermal pad area on the PCB to achieve proper thermal connection. Additionally, for good thermal performance, the thermal pad on the PCB must have sufficient number of thermal vias connected to the GND planes on the PCB.

10.2 Layout Example

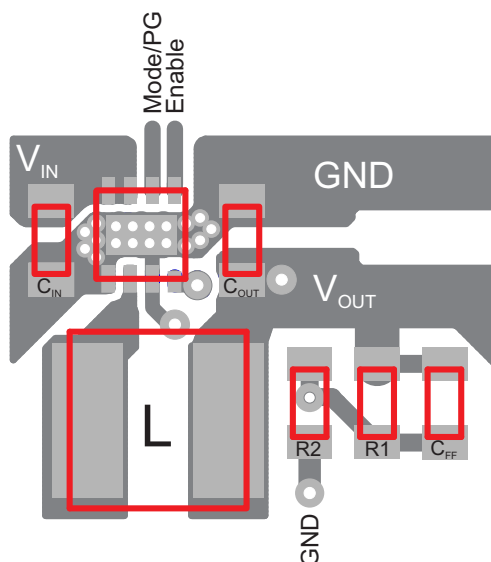

Figure 24. PCB Layout

11 Device and Documentation Support

11.1 Documentation Support

11.1.1 Related Documentation

For related documentation see the following:

[TLV62065EVM-719 User's Guide \(SLVU424\)](#)

11.2 Receiving Notification of Documentation Updates

To receive notification of documentation updates, navigate to the device product folder on ti.com. In the upper right corner, click on *Alert me* to register and receive a weekly digest of any product information that has changed. For change details, review the revision history included in any revised document.

11.3 Community Resource

The following links connect to TI community resources. Linked contents are provided "AS IS" by the respective contributors. They do not constitute TI specifications and do not necessarily reflect TI's views; see TI's [Terms of Use](#).

TI E2E™ Online Community *TI's Engineer-to-Engineer (E2E) Community*. Created to foster collaboration among engineers. At e2e.ti.com, you can ask questions, share knowledge, explore ideas and help solve problems with fellow engineers.

Design Support *TI's Design Support* Quickly find helpful E2E forums along with design support tools and contact information for technical support.

11.4 Trademarks

E2E is a trademark of Texas Instruments.

All other trademarks are the property of their respective owners.

11.5 Electrostatic Discharge Caution



These devices have limited built-in ESD protection. The leads should be shorted together or the device placed in conductive foam during storage or handling to prevent electrostatic damage to the MOS gates.

11.6 Glossary

[SLYZ022](#) — *TI Glossary*.

This glossary lists and explains terms, acronyms, and definitions.

12 Mechanical, Packaging, and Orderable Information

The following pages include mechanical, packaging, and orderable information. This information is the most current data available for the designated devices. This data is subject to change without notice and revision of this document. For browser-based versions of this data sheet, refer to the left-hand navigation.

PACKAGING INFORMATION

Orderable Device	Status (1)	Package Type	Package Drawing	Pins	Package Qty	Eco Plan (2)	Lead/Ball Finish (6)	MSL Peak Temp (3)	Op Temp (°C)	Device Marking (4/5)	Samples
TLV62065TDSGRQ1	ACTIVE	WSON	DSG	8	3000	Green (RoHS & no Sb/Br)	CU NIPDAU	Level-2-260C-1 YEAR	-40 to 105	SCD	Samples

(1) The marketing status values are defined as follows:

ACTIVE: Product device recommended for new designs.

LIFEBUY: TI has announced that the device will be discontinued, and a lifetime-buy period is in effect.

NRND: Not recommended for new designs. Device is in production to support existing customers, but TI does not recommend using this part in a new design.

PREVIEW: Device has been announced but is not in production. Samples may or may not be available.

OBSOLETE: TI has discontinued the production of the device.

(2) Eco Plan - The planned eco-friendly classification: Pb-Free (RoHS), Pb-Free (RoHS Exempt), or Green (RoHS & no Sb/Br) - please check <http://www.ti.com/productcontent> for the latest availability information and additional product content details.

TBD: The Pb-Free/Green conversion plan has not been defined.

Pb-Free (RoHS): TI's terms "Lead-Free" or "Pb-Free" mean semiconductor products that are compatible with the current RoHS requirements for all 6 substances, including the requirement that lead not exceed 0.1% by weight in homogeneous materials. Where designed to be soldered at high temperatures, TI Pb-Free products are suitable for use in specified lead-free processes.

Pb-Free (RoHS Exempt): This component has a RoHS exemption for either 1) lead-based flip-chip solder bumps used between the die and package, or 2) lead-based die adhesive used between the die and leadframe. The component is otherwise considered Pb-Free (RoHS compatible) as defined above.

Green (RoHS & no Sb/Br): TI defines "Green" to mean Pb-Free (RoHS compatible), and free of Bromine (Br) and Antimony (Sb) based flame retardants (Br or Sb do not exceed 0.1% by weight in homogeneous material)

(3) MSL, Peak Temp. - The Moisture Sensitivity Level rating according to the JEDEC industry standard classifications, and peak solder temperature.

(4) There may be additional marking, which relates to the logo, the lot trace code information, or the environmental category on the device.

(5) Multiple Device Markings will be inside parentheses. Only one Device Marking contained in parentheses and separated by a "~" will appear on a device. If a line is indented then it is a continuation of the previous line and the two combined represent the entire Device Marking for that device.

(6) Lead/Ball Finish - Orderable Devices may have multiple material finish options. Finish options are separated by a vertical ruled line. Lead/Ball Finish values may wrap to two lines if the finish value exceeds the maximum column width.

Important Information and Disclaimer: The information provided on this page represents TI's knowledge and belief as of the date that it is provided. TI bases its knowledge and belief on information provided by third parties, and makes no representation or warranty as to the accuracy of such information. Efforts are underway to better integrate information from third parties. TI has taken and continues to take reasonable steps to provide representative and accurate information but may not have conducted destructive testing or chemical analysis on incoming materials and chemicals. TI and TI suppliers consider certain information to be proprietary, and thus CAS numbers and other limited information may not be available for release.

In no event shall TI's liability arising out of such information exceed the total purchase price of the TI part(s) at issue in this document sold by TI to Customer on an annual basis.

OTHER QUALIFIED VERSIONS OF TLV62065-Q1 :

- Catalog: [TLV62065](#)

NOTE: Qualified Version Definitions:

- Catalog - TI's standard catalog product

TAPE AND REEL INFORMATION



QUADRANT ASSIGNMENTS FOR PIN 1 ORIENTATION IN TAPE



*All dimensions are nominal

Device	Package Type	Package Drawing	Pins	SPQ	Reel Diameter (mm)	Reel Width W1 (mm)	A0 (mm)	B0 (mm)	K0 (mm)	P1 (mm)	W (mm)	Pin1 Quadrant
TLV62065TDSGRQ1	WSON	DSG	8	3000	179.0	8.4	2.2	2.2	1.2	4.0	8.0	Q2

TAPE AND REEL BOX DIMENSIONS



*All dimensions are nominal

Device	Package Type	Package Drawing	Pins	SPQ	Length (mm)	Width (mm)	Height (mm)
TLV62065TDSGRQ1	WSON	DSG	8	3000	195.0	200.0	45.0

GENERIC PACKAGE VIEW

DSG 8

WSON - 0.8 mm max height

PLASTIC SMALL OUTLINE - NO LEAD

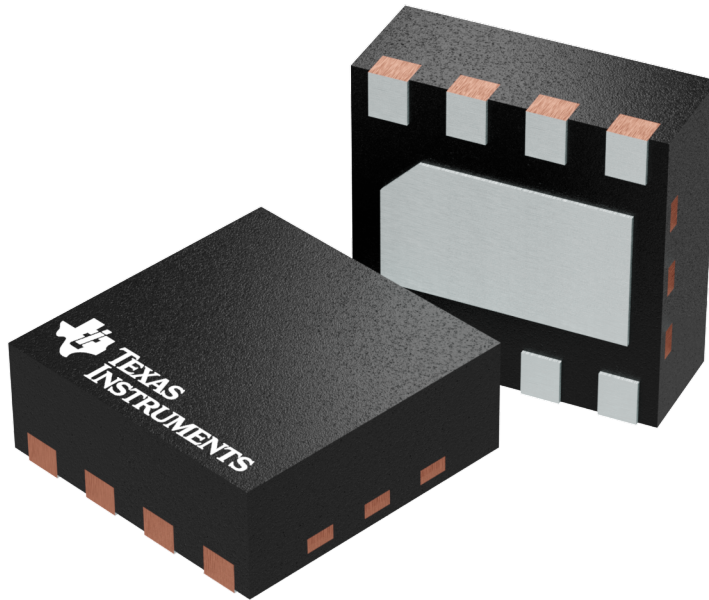

Images above are just a representation of the package family, actual package may vary.
Refer to the product data sheet for package details.

4208210/C

DSG0008A

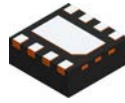

PACKAGE OUTLINE

WSON - 0.8 mm max height

PLASTIC SMALL OUTLINE - NO LEAD

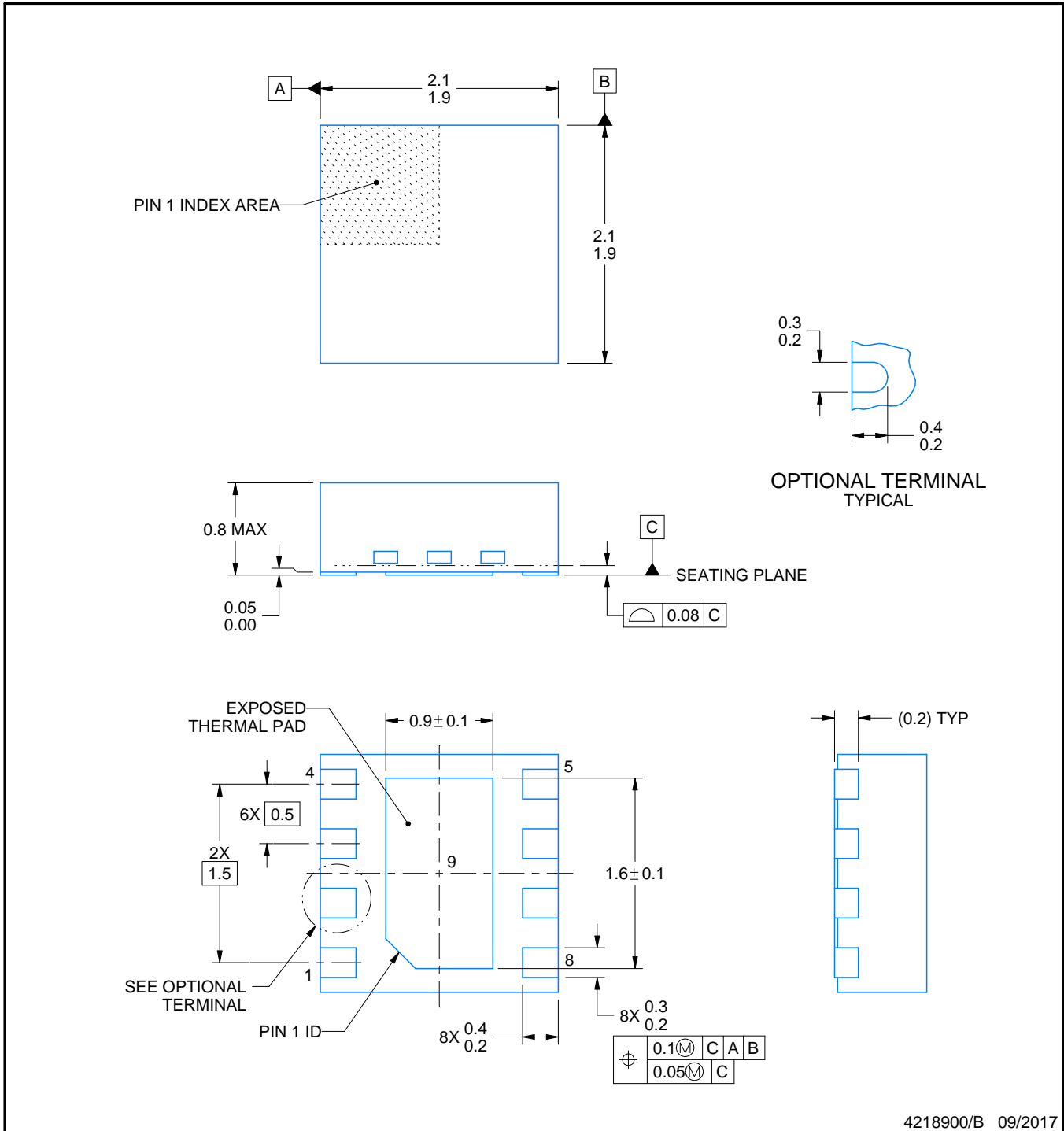

4218900/B 09/2017

NOTES:

1. All linear dimensions are in millimeters. Any dimensions in parenthesis are for reference only. Dimensioning and tolerancing per ASME Y14.5M.
2. This drawing is subject to change without notice.
3. The package thermal pad must be soldered to the printed circuit board for thermal and mechanical performance.

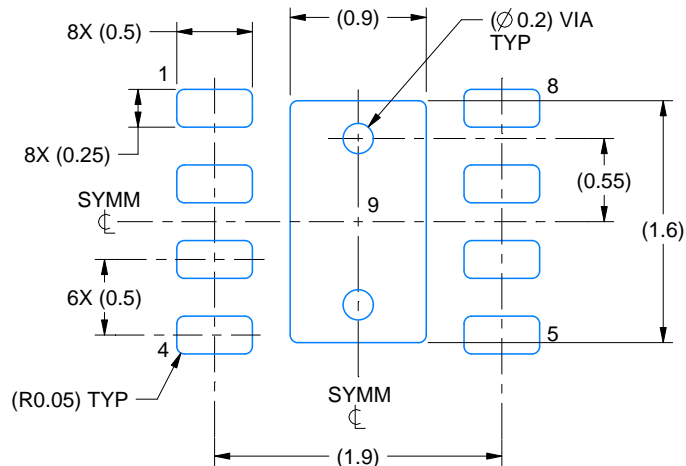

LAND PATTERN EXAMPLE
SCALE:20X

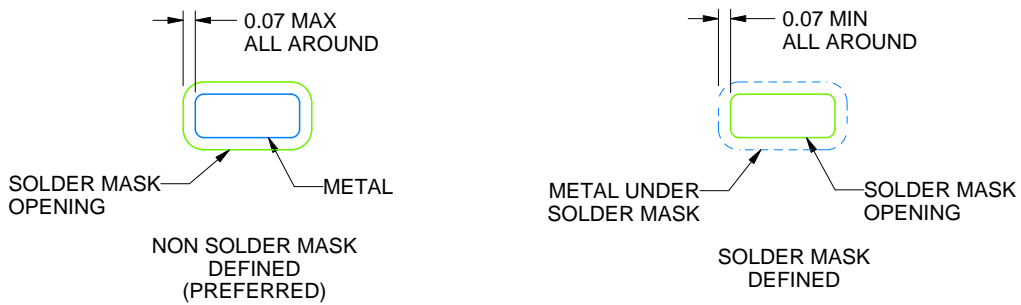

SOLDER MASK DETAILS

4218900/B 09/2017

NOTES: (continued)

- This package is designed to be soldered to a thermal pad on the board. For more information, see Texas Instruments literature number SLUA271 (www.ti.com/lit/slua271).
- Vias are optional depending on application, refer to device data sheet. If any vias are implemented, refer to their locations shown on this view. It is recommended that vias under paste be filled, plugged or tented.

EXAMPLE STENCIL DESIGN

DSG0008A

WSON - 0.8 mm max height

PLASTIC SMALL OUTLINE - NO LEAD

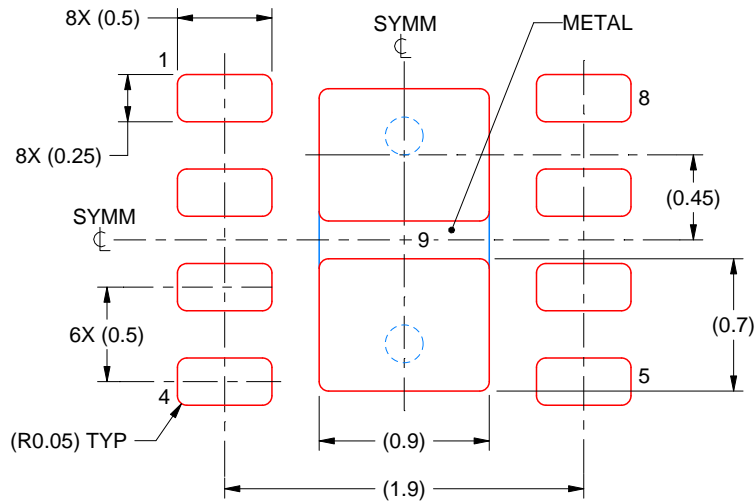

SOLDER PASTE EXAMPLE
BASED ON 0.125 mm THICK STENCIL

EXPOSED PAD 9:
87% PRINTED SOLDER COVERAGE BY AREA UNDER PACKAGE
SCALE:25X

4218900/B 09/2017

NOTES: (continued)

6. Laser cutting apertures with trapezoidal walls and rounded corners may offer better paste release. IPC-7525 may have alternate design recommendations.

IMPORTANT NOTICE

Texas Instruments Incorporated (TI) reserves the right to make corrections, enhancements, improvements and other changes to its semiconductor products and services per JESD46, latest issue, and to discontinue any product or service per JESD48, latest issue. Buyers should obtain the latest relevant information before placing orders and should verify that such information is current and complete.

TI's published terms of sale for semiconductor products (<http://www.ti.com/sc/docs/stdterms.htm>) apply to the sale of packaged integrated circuit products that TI has qualified and released to market. Additional terms may apply to the use or sale of other types of TI products and services.

Reproduction of significant portions of TI information in TI data sheets is permissible only if reproduction is without alteration and is accompanied by all associated warranties, conditions, limitations, and notices. TI is not responsible or liable for such reproduced documentation. Information of third parties may be subject to additional restrictions. Resale of TI products or services with statements different from or beyond the parameters stated by TI for that product or service voids all express and any implied warranties for the associated TI product or service and is an unfair and deceptive business practice. TI is not responsible or liable for any such statements.

Buyers and others who are developing systems that incorporate TI products (collectively, "Designers") understand and agree that Designers remain responsible for using their independent analysis, evaluation and judgment in designing their applications and that Designers have full and exclusive responsibility to assure the safety of Designers' applications and compliance of their applications (and of all TI products used in or for Designers' applications) with all applicable regulations, laws and other applicable requirements. Designer represents that, with respect to their applications, Designer has all the necessary expertise to create and implement safeguards that (1) anticipate dangerous consequences of failures, (2) monitor failures and their consequences, and (3) lessen the likelihood of failures that might cause harm and take appropriate actions. Designer agrees that prior to using or distributing any applications that include TI products, Designer will thoroughly test such applications and the functionality of such TI products as used in such applications.

TI's provision of technical, application or other design advice, quality characterization, reliability data or other services or information, including, but not limited to, reference designs and materials relating to evaluation modules, (collectively, "TI Resources") are intended to assist designers who are developing applications that incorporate TI products; by downloading, accessing or using TI Resources in any way, Designer (individually or, if Designer is acting on behalf of a company, Designer's company) agrees to use any particular TI Resource solely for this purpose and subject to the terms of this Notice.

TI's provision of TI Resources does not expand or otherwise alter TI's applicable published warranties or warranty disclaimers for TI products, and no additional obligations or liabilities arise from TI providing such TI Resources. TI reserves the right to make corrections, enhancements, improvements and other changes to its TI Resources. TI has not conducted any testing other than that specifically described in the published documentation for a particular TI Resource.

Designer is authorized to use, copy and modify any individual TI Resource only in connection with the development of applications that include the TI product(s) identified in such TI Resource. NO OTHER LICENSE, EXPRESS OR IMPLIED, BY ESTOPPEL OR OTHERWISE TO ANY OTHER TI INTELLECTUAL PROPERTY RIGHT, AND NO LICENSE TO ANY TECHNOLOGY OR INTELLECTUAL PROPERTY RIGHT OF TI OR ANY THIRD PARTY IS GRANTED HEREIN, including but not limited to any patent right, copyright, mask work right, or other intellectual property right relating to any combination, machine, or process in which TI products or services are used. Information regarding or referencing third-party products or services does not constitute a license to use such products or services, or a warranty or endorsement thereof. Use of TI Resources may require a license from a third party under the patents or other intellectual property of the third party, or a license from TI under the patents or other intellectual property of TI.

TI RESOURCES ARE PROVIDED "AS IS" AND WITH ALL FAULTS. TI DISCLAIMS ALL OTHER WARRANTIES OR REPRESENTATIONS, EXPRESS OR IMPLIED, REGARDING RESOURCES OR USE THEREOF, INCLUDING BUT NOT LIMITED TO ACCURACY OR COMPLETENESS, TITLE, ANY EPIDEMIC FAILURE WARRANTY AND ANY IMPLIED WARRANTIES OF MERCHANTABILITY, FITNESS FOR A PARTICULAR PURPOSE, AND NON-INFRINGEMENT OF ANY THIRD PARTY INTELLECTUAL PROPERTY RIGHTS. TI SHALL NOT BE LIABLE FOR AND SHALL NOT DEFEND OR INDEMNIFY DESIGNER AGAINST ANY CLAIM, INCLUDING BUT NOT LIMITED TO ANY INFRINGEMENT CLAIM THAT RELATES TO OR IS BASED ON ANY COMBINATION OF PRODUCTS EVEN IF DESCRIBED IN TI RESOURCES OR OTHERWISE. IN NO EVENT SHALL TI BE LIABLE FOR ANY ACTUAL, DIRECT, SPECIAL, COLLATERAL, INDIRECT, PUNITIVE, INCIDENTAL, CONSEQUENTIAL OR EXEMPLARY DAMAGES IN CONNECTION WITH OR ARISING OUT OF TI RESOURCES OR USE THEREOF, AND REGARDLESS OF WHETHER TI HAS BEEN ADVISED OF THE POSSIBILITY OF SUCH DAMAGES.

Unless TI has explicitly designated an individual product as meeting the requirements of a particular industry standard (e.g., ISO/TS 16949 and ISO 26262), TI is not responsible for any failure to meet such industry standard requirements.

Where TI specifically promotes products as facilitating functional safety or as compliant with industry functional safety standards, such products are intended to help enable customers to design and create their own applications that meet applicable functional safety standards and requirements. Using products in an application does not by itself establish any safety features in the application. Designers must ensure compliance with safety-related requirements and standards applicable to their applications. Designer may not use any TI products in life-critical medical equipment unless authorized officers of the parties have executed a special contract specifically governing such use. Life-critical medical equipment is medical equipment where failure of such equipment would cause serious bodily injury or death (e.g., life support, pacemakers, defibrillators, heart pumps, neurostimulators, and implantables). Such equipment includes, without limitation, all medical devices identified by the U.S. Food and Drug Administration as Class III devices and equivalent classifications outside the U.S.

TI may expressly designate certain products as completing a particular qualification (e.g., Q100, Military Grade, or Enhanced Product). Designers agree that it has the necessary expertise to select the product with the appropriate qualification designation for their applications and that proper product selection is at Designers' own risk. Designers are solely responsible for compliance with all legal and regulatory requirements in connection with such selection.

Designer will fully indemnify TI and its representatives against any damages, costs, losses, and/or liabilities arising out of Designer's non-compliance with the terms and provisions of this Notice.