

TPS76030, TPS76032, TPS76033, TPS76038, TPS76050 LOW-POWER 50-mA LOW-DROPOUT LINEAR REGULATORS

SLVS144D – JULY 1998 – REVISED MAY 2001

- 50-mA Low-Dropout Regulator
- Fixed Output Voltage Options: 5 V, 3.8 V, 3.3 V, 3.2 V, and 3 V
- Dropout Typically 120 mV at 50 mA
- Thermal Protection
- Less Than 1- μ A Quiescent Current in Shutdown
- -40°C to 125°C Operating Junction Temperature Range
- 5-Pin SOT-23 Package
- ESD Protection Verified to 1.5 kV Human Body Model (HBM) per MIL-STD-883C

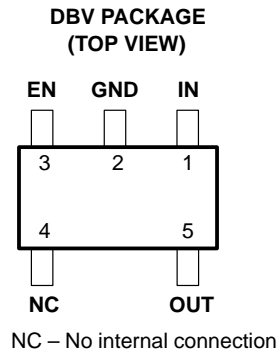

description

The TPS760xx is a 50 mA, low dropout (LDO) voltage regulator designed specifically for battery-powered applications. A proprietary BiCMOS fabrication process allows the TPS760xx to provide outstanding performance in all specifications critical to battery-powered operation.

The TPS760xx is available in a space-saving SOT-23 package and operates over a junction temperature range of -40°C to 125°C .

AVAILABLE OPTIONS

T_J	VOLTAGE	PACKAGE	PART NUMBER	SYMBOL
-40°C to 125°C	3 V	SOT-23	TPS76030DBVR	PAGI
	3.2 V		TPS76032DBVR	PAOI
	3.3 V		TPS76033DBVR	PAHI
	3.8 V		TPS76038DBVR	PAJI
	5 V		TPS76050DBVR	PANI

NOTE: The DBV package is available taped and reeled only.

functional block diagram

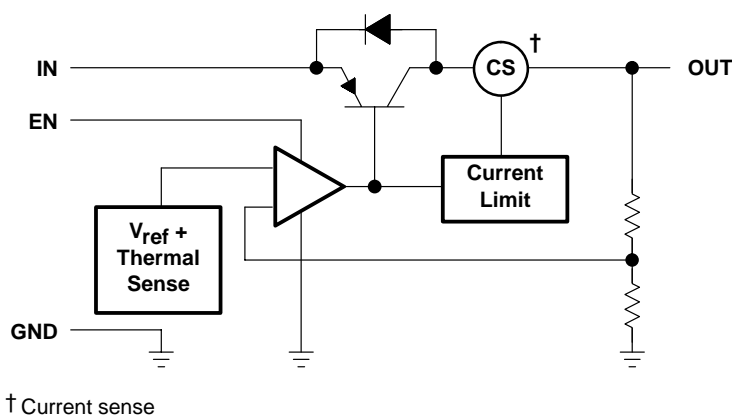

Please be aware that an important notice concerning availability, standard warranty, and use in critical applications of Texas Instruments semiconductor products and disclaimers thereto appears at the end of this data sheet.

PRODUCTION DATA information is current as of publication date. Products conform to specifications per the terms of Texas Instruments standard warranty. Production processing does not necessarily include testing of all parameters.

**TEXAS
INSTRUMENTS**

POST OFFICE BOX 655303 • DALLAS, TEXAS 75265

Copyright © 2001, Texas Instruments Incorporated

TPS76030, TPS76032, TPS76033, TPS76038, TPS76050

LOW-POWER 50-mA LOW-DROPOUT LINEAR REGULATORS

SLVS144D – JULY 1998 – REVISED MAY 2001

Terminal Functions

TERMINAL NAME	NO.	I/O	DESCRIPTION
EN	3	I	Enable input
GND	2		Ground
IN	1	I	Input voltage
NC	4		No connection
OUT	5	O	Regulated output voltage

absolute maximum ratings over operating free-air temperature range (unless otherwise noted)†

Input voltage range, V_I ‡	–0.3 V to 16 V
Voltage range at EN	–0.3 V to $V_I + 0.3$ V
Peak output current	internally limited
Continuous total dissipation	See Dissipation Rating Table
Operating junction temperature range, T_J	–40°C to 150°C
Storage temperature range, T_{stg}	–65°C to 150°C
ESD rating, HBM	1.5 kV

† Stresses beyond those listed under “absolute maximum ratings” may cause permanent damage to the device. These are stress ratings only, and functional operation of the device at these or any other conditions beyond those indicated under “recommended operating conditions” is not implied. Exposure to absolute-maximum-rated conditions for extended periods may affect device reliability.

‡ All voltages are with respect to device GND pin.

DISSIPATION RATING TABLE

BOARD	PACKAGE	$R_{\theta JC}$	$R_{\theta JA}$	DERATING FACTOR ABOVE $T_A = 25^\circ\text{C}$	$T_A \leq 25^\circ\text{C}$ POWER RATING	$T_A = 70^\circ\text{C}$ POWER RATING	$T_A = 85^\circ\text{C}$ POWER RATING
Low K§	DBV	65.8 °C/W	259 °C/W	3.9 mW/°C	386 mW	212 mW	154 mW
High K¶	DBV	65.8 °C/W	180 °C/W	5.6 mW/°C	555 mW	305 mW	222 mW

§ The JEDEC Low K (1s) board design used to derive this data was a 3 inch x 3 inch, two layer board with 2 ounce copper traces on top of the board.

¶ The JEDEC High K (2s2p) board design used to derive this data was a 3 inch x 3 inch, multilayer board with 1 ounce internal power and ground planes and 2 ounce copper traces on top and bottom of the board.

recommended operating conditions

		MIN	NOM	MAX	UNIT
Input voltage, V_I	TPS76030	3.2		16	V
	TPS76032	3.4		16	
	TPS76033	3.5		16	
	TPS76038	4		16	
	TPS76050	5.2		16	
Continuous output current, I_O		0		50	mA
Operating junction temperature, T_J		–40		125	°C



POST OFFICE BOX 655303 • DALLAS, TEXAS 75265

TPS76030, TPS76032, TPS76033, TPS76038, TPS76050 LOW-POWER 50-mA LOW-DROPOUT LINEAR REGULATORS

SLVS144D – JULY 1998 – REVISED MAY 2001

**electrical characteristics over recommended operating free-air temperature range,
 $V_I = V_{O(nom)} + 1\text{ V}$, $I_O = 1\text{ mA}$, $EN = V_I$, $C_O = 2.2\text{ }\mu\text{F}$ (unless otherwise noted)**

PARAMETER		TEST CONDITIONS	MIN	TYP	MAX	UNIT		
V_O	Output voltage	TPS76030	$T_J = 25^\circ\text{C}$	2.96	3	3.04	V	
			$T_J = 25^\circ\text{C}$, $1\text{ mA} < I_O < 50\text{ mA}$	2.92		3.04		
			$1\text{ mA} < I_O < 50\text{ mA}$	2.91		3.07		
	Output voltage	TPS76032	TPS76032	$T_J = 25^\circ\text{C}$	3.16	3.2	3.24	V
				$T_J = 25^\circ\text{C}$, $1\text{ mA} < I_O < 50\text{ mA}$	3.13		3.24	
				$1\text{ mA} < I_O < 50\text{ mA}$	3.1		3.3	
	Output voltage	TPS76033	TPS76033	$T_J = 25^\circ\text{C}$	3.26	3.3	3.34	V
				$T_J = 25^\circ\text{C}$, $1\text{ mA} < I_O < 50\text{ mA}$	3.23		3.34	
				$1\text{ mA} < I_O < 50\text{ mA}$	3.2		3.4	
	Output voltage	TPS76038	TPS76038	$T_J = 25^\circ\text{C}$	3.76	3.8	3.84	V
				$T_J = 25^\circ\text{C}$, $1\text{ mA} < I_O < 50\text{ mA}$	3.73		3.84	
				$1\text{ mA} < I_O < 50\text{ mA}$	3.7		3.9	
	Output voltage	TPS76050	TPS76050	$T_J = 25^\circ\text{C}$	4.95	5	5.05	V
				$T_J = 25^\circ\text{C}$, $1\text{ mA} < I_O < 50\text{ mA}$	4.91		5.05	
				$1\text{ mA} < I_O < 50\text{ mA}$	4.89		5.1	
$I_{I(\text{standby})}$	Standby current	$EN = 0\text{ V}$			1	μA		
	Quiescent current (GND current)		$I_O = 0\text{ mA}$, $T_J = 25^\circ\text{C}$		90	115	μA	
			$I_O = 0\text{ mA}$			130		
			$I_O = 1\text{ mA}$, $T_J = 25^\circ\text{C}$		100	130		
			$I_O = 1\text{ mA}$			170		
			$I_O = 10\text{ mA}$, $T_J = 25^\circ\text{C}$		190	215		
			$I_O = 10\text{ mA}$			260		
			$I_O = 50\text{ mA}$, $T_J = 25^\circ\text{C}$		850	1100		
			$I_O = 50\text{ mA}$			1200		
Input regulation		TPS76030	$4\text{ V} < V_I < 16$, $I_O = 1\text{ mA}$		3	10	mV	
		TPS76032	$4.2\text{ V} < V_I < 16$, $I_O = 1\text{ mA}$		3	10		
		TPS76033	$4.3\text{ V} < V_I < 16$, $I_O = 1\text{ mA}$		3	10		
		TPS76038	$4.8\text{ V} < V_I < 16$, $I_O = 1\text{ mA}$		3	10		
		TPS76050	$6\text{ V} < V_I < 16$, $I_O = 1\text{ mA}$		3	10		
V_n	Output noise voltage	$BW = 300\text{ Hz to } 50\text{ kHz}$, $C_O = 10\text{ }\mu\text{F}$, $T_J = 25^\circ\text{C}$		190		μVrms		
	Ripple rejection	$f = 1\text{ kHz}$, $C_O = 10\text{ }\mu\text{F}$, $T_J = 25^\circ\text{C}$		63		dB		
Dropout voltage			$I_O = 0\text{ mA}$, $T_J = 25^\circ\text{C}$		1	3	mV	
			$I_O = 0\text{ mA}$			5		
			$I_O = 1\text{ mA}$, $T_J = 25^\circ\text{C}$		7	10		
			$I_O = 1\text{ mA}$			15		
			$I_O = 10\text{ mA}$, $T_J = 25^\circ\text{C}$		40	60		
			$I_O = 10\text{ mA}$			90		
			$I_O = 50\text{ mA}$, $T_J = 25^\circ\text{C}$		120	150		
			180					
	Peak output current/current limit		100	125	135	mA		
	High level enable input		2			V		
	Low level enable input				0.8	V		
I_I	Input current (EN)	$EN = 0\text{ V}$	-1	0	1	μA		
		$EN = V_I$		2.5	5	μA		



TPS76030, TPS76032, TPS76033, TPS76038, TPS76050
LOW-POWER 50-mA LOW-DROPOUT LINEAR REGULATORS

SLVS144D – JULY 1998 – REVISED MAY 2001

Table of Graphs

			FIGURE
V _O	Output voltage	vs Output current	1, 2, 3
		vs Free-air temperature	4, 5, 6
	Ground current	vs Free-air temperature	7, 8, 9
	Output noise	vs Frequency	10
Z _O	Output impedance	vs Frequency	11
V _{DO}	Dropout voltage	vs Free-air temperature	12
	Line transient response		13, 15
	Load transient response		14, 16



POST OFFICE BOX 655303 • DALLAS, TEXAS 75265

TYPICAL CHARACTERISTICS

TPS76030
 OUTPUT VOLTAGE
 vs
 OUTPUT CURRENT

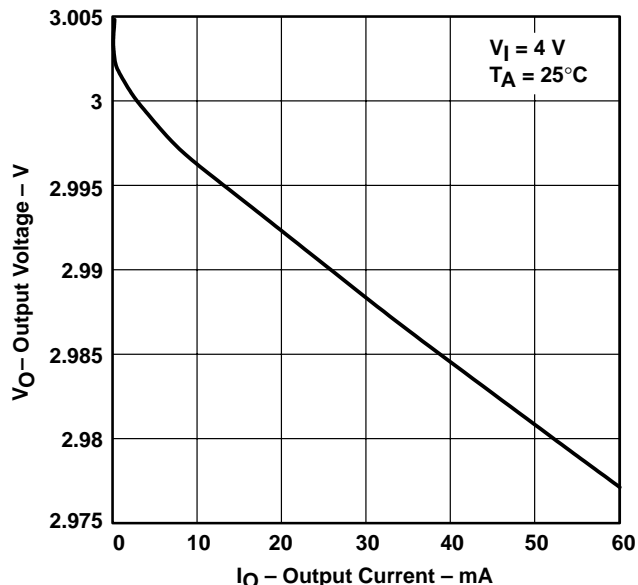

Figure 1

TPS76033
 OUTPUT VOLTAGE
 vs
 OUTPUT CURRENT

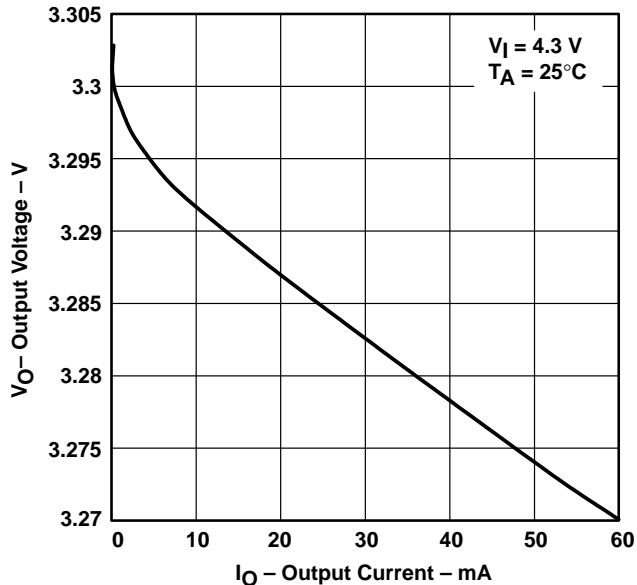

Figure 2

TPS76050
 OUTPUT VOLTAGE
 vs
 OUTPUT CURRENT

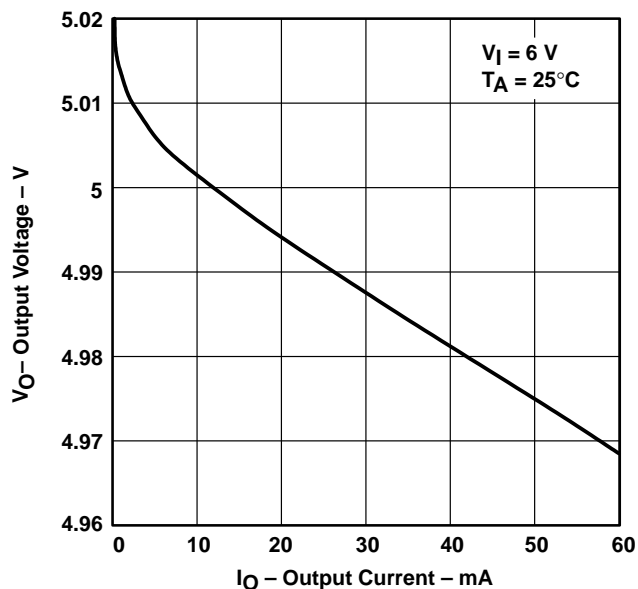

Figure 3

TPS76030
 OUTPUT VOLTAGE
 vs
 FREE-AIR TEMPERATURE

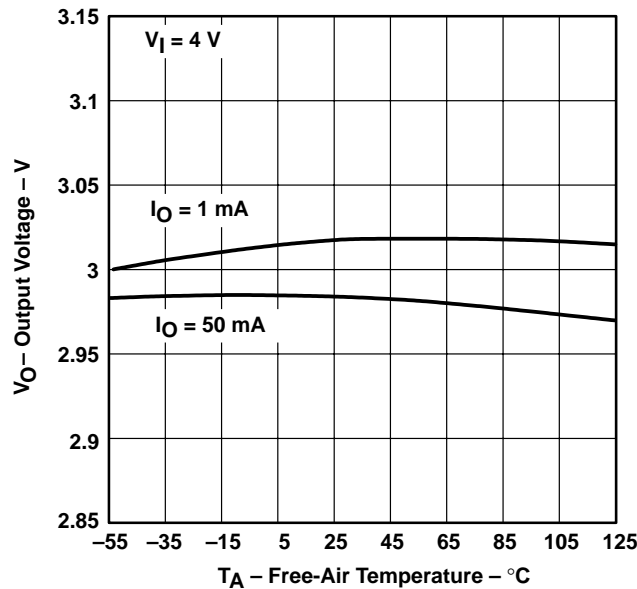

Figure 4

TPS76030, TPS76032, TPS76033, TPS76038, TPS76050 LOW-POWER 50-mA LOW-DROPOUT LINEAR REGULATORS

SLVS144D – JULY 1998 – REVISED MAY 2001

TYPICAL CHARACTERISTICS

TPS76033
OUTPUT VOLTAGE
vs
FREE-AIR TEMPERATURE

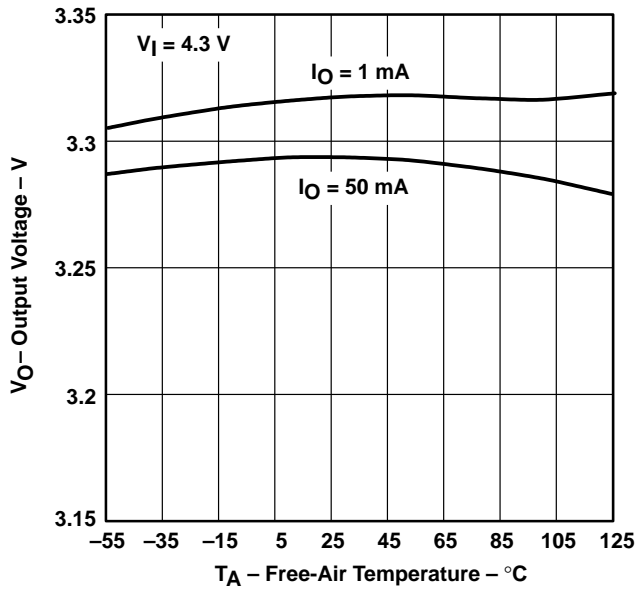

Figure 5

TPS76050
OUTPUT VOLTAGE
vs
FREE-AIR TEMPERATURE

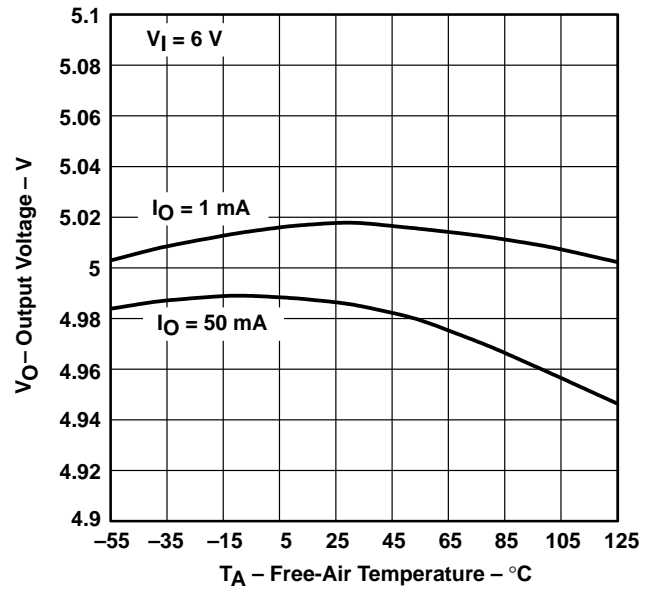

Figure 6

TPS76030
GROUND CURRENT
vs
FREE-AIR TEMPERATURE

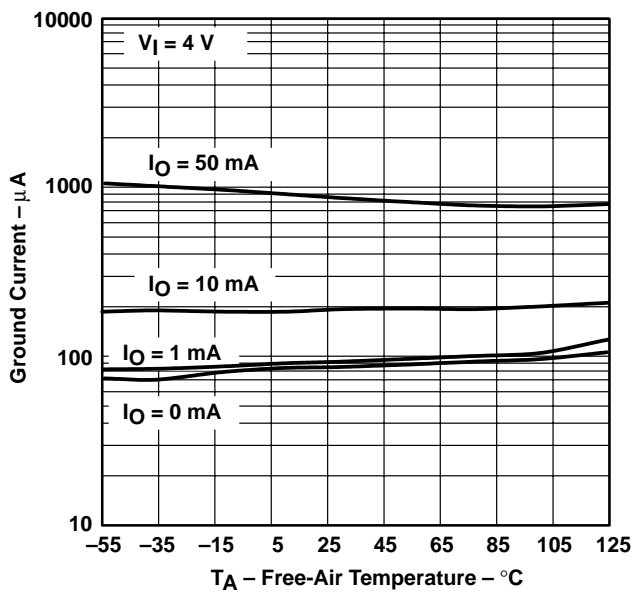

Figure 7

TPS76033
GROUND CURRENT
vs
FREE-AIR TEMPERATURE

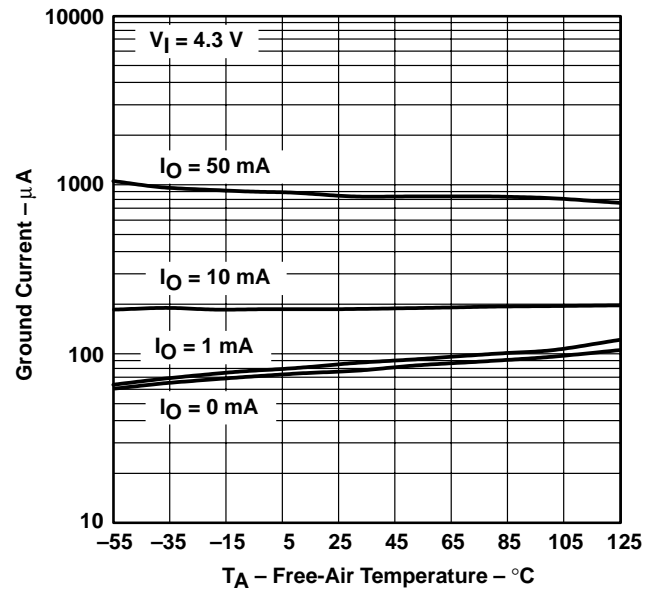

Figure 8



TYPICAL CHARACTERISTICS

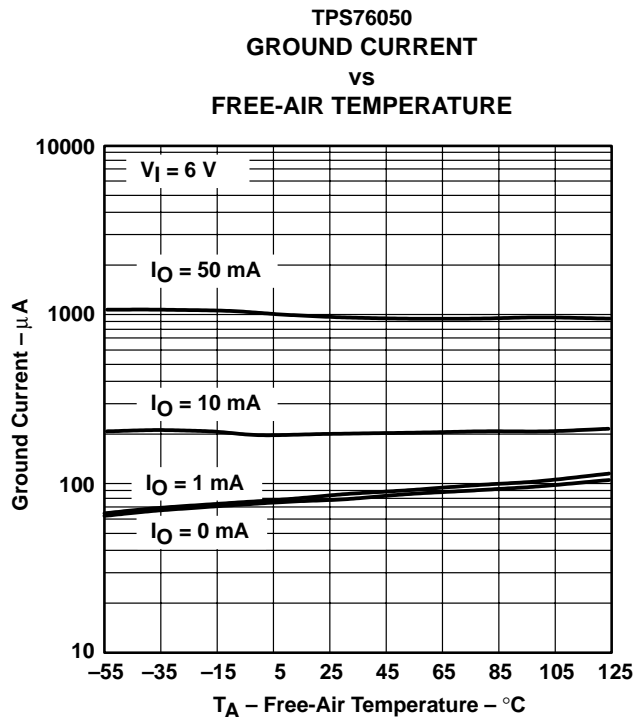

Figure 9

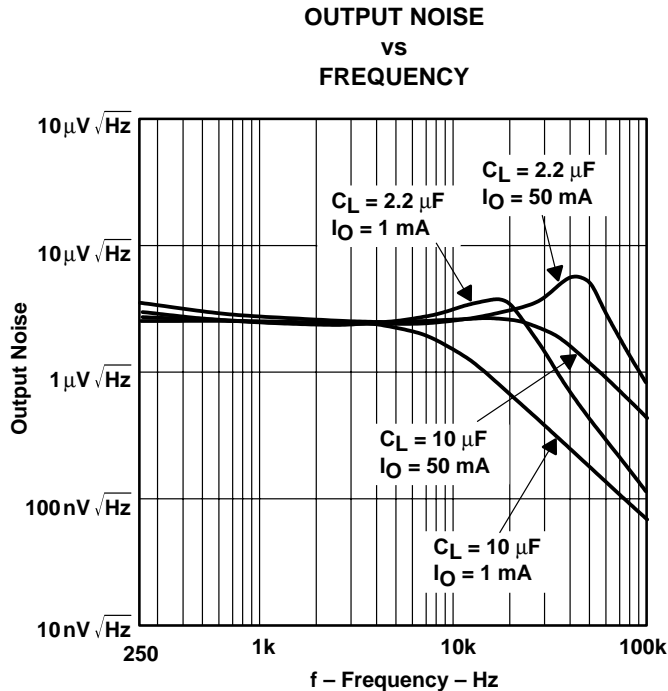

Figure 10

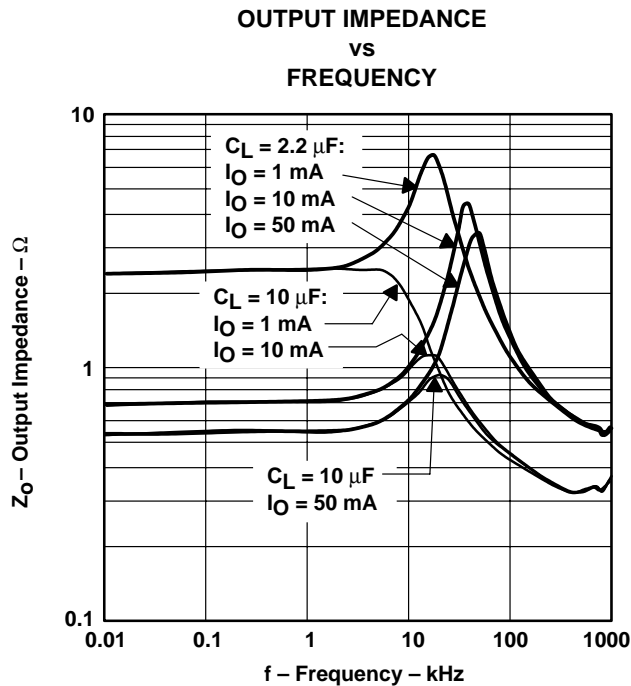

Figure 11

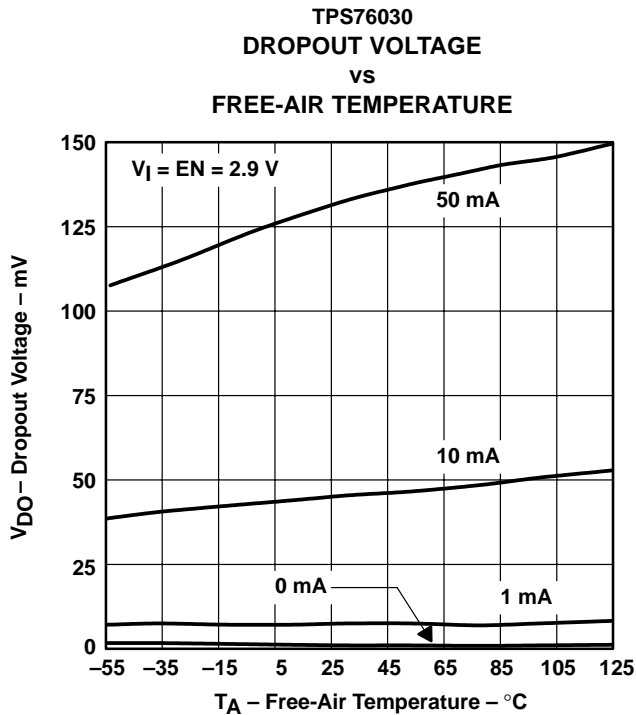

Figure 12

TPS76030, TPS76032, TPS76033, TPS76038, TPS76050

LOW-POWER 50-mA LOW-DROPOUT LINEAR REGULATORS

SLVS144D – JULY 1998 – REVISED MAY 2001

TYPICAL CHARACTERISTICS

TPS76033
LINE TRANSIENT RESPONSE

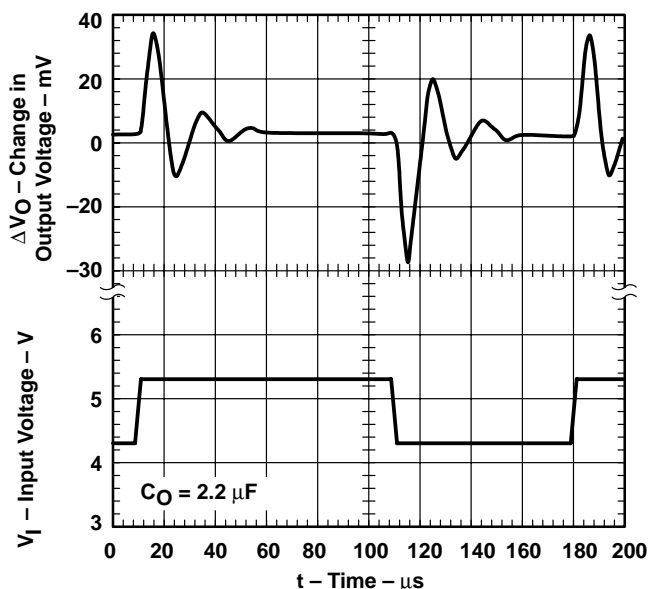

Figure 13

TPS76033
LOAD TRANSIENT RESPONSE

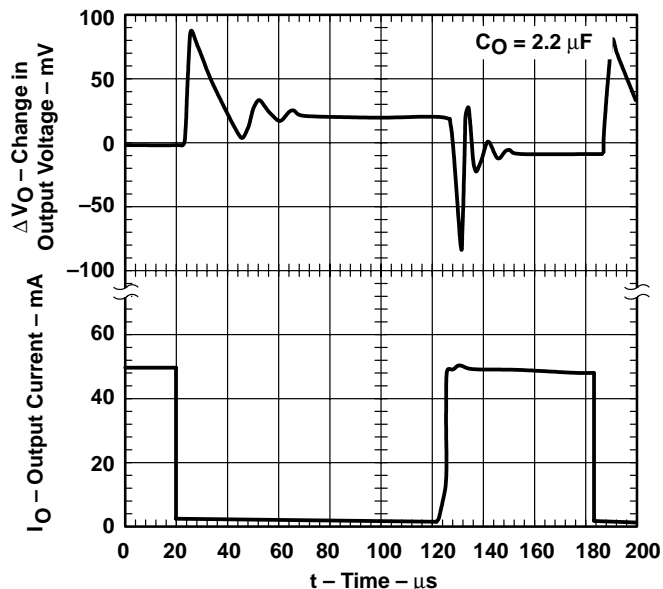

Figure 14

TPS76050
LINE TRANSIENT RESPONSE

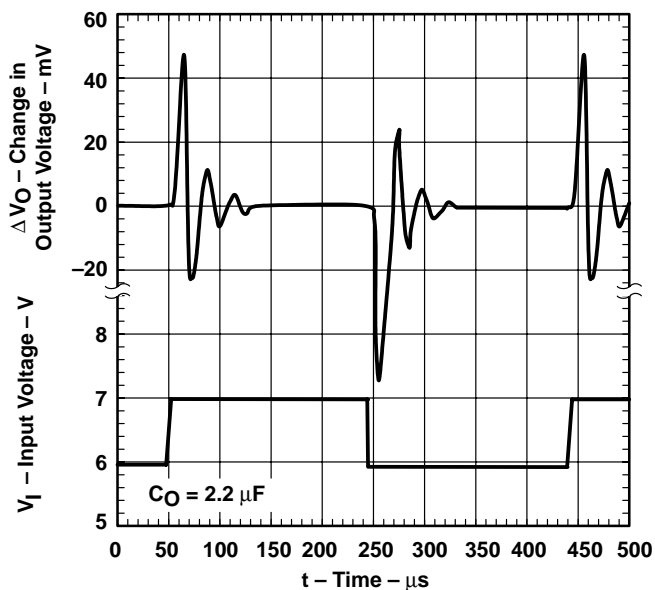

Figure 15

TPS76050
LOAD TRANSIENT RESPONSE

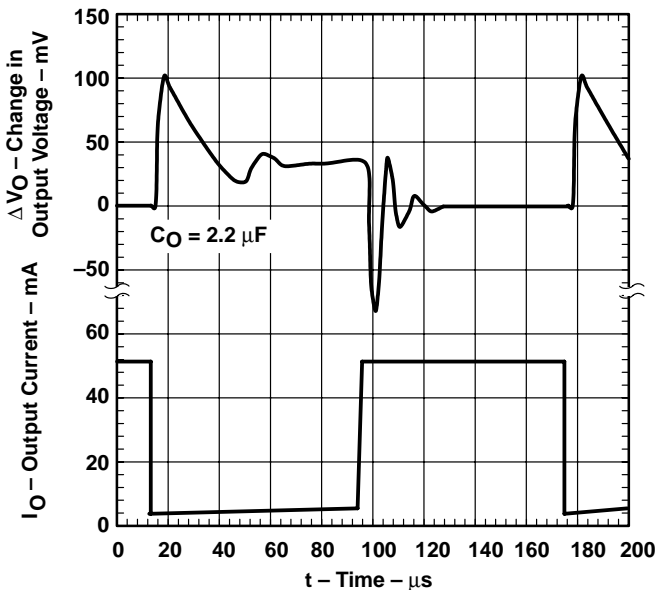

Figure 16



POST OFFICE BOX 655303 • DALLAS, TEXAS 75265

APPLICATION INFORMATION

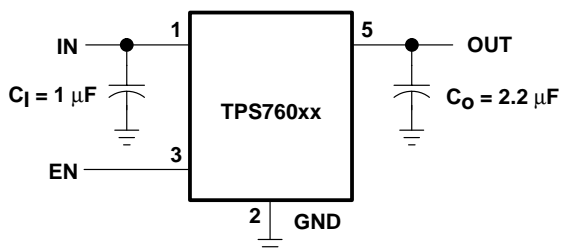

Figure 17. TPS760xx Typical Application

over current protection

The over current protection circuit forces the TPS760xx into a constant current output mode when the load is excessive or the output is shorted to ground. Normal operation resumes when the fault condition is removed. An overload or short circuit may also activate the over temperature protection if the fault condition persists.

over temperature protection

The thermal protection system shuts the TPS760xx down when the junction temperature exceeds 160°C. The device recovers and operates normally when the temperature drops below 155°C.

input capacitor

A 0.047 µF or larger ceramic decoupling capacitor with short leads connected between IN and GND is recommended. The decoupling capacitor may be omitted if there is a 1 µF or larger electrolytic capacitor connected between IN and GND and located reasonably close to the TPS760xx. However, the small ceramic device is desirable even when the larger capacitor is present, if there is a lot of high frequency noise present in the system.

output capacitor

Like all low dropout regulators, the TPS760xx requires an output capacitor connected between OUT and GND to stabilize the internal control loop. The minimum recommended capacitance value is 2.2 µF and the ESR (equivalent series resistance) must be between 0.1 Ω and 20 Ω. Capacitor values of 2.5-µF or larger are acceptable, provided the ESR is less than 20 Ω. Solid tantalum electrolytic, aluminum electrolytic, and multilayer ceramic capacitors are all suitable, provided they meet the requirements described above. Most of the commercially available 2.2-µF surface-mount solid-tantalum capacitors, including devices from Sprague, Kemet, and Nichicon, meet the ESR requirements stated above. Multilayer ceramic capacitors should have minimum values of 2.5 µF over the full operating temperature range of the equipment.

enable (EN)

A logic zero on the enable input shuts the TPS760xx off and reduces the supply current to less than 1 µA. Pulling the enable input high causes normal operation to resume. If the enable feature is not used, EN should be connected to IN to keep the regulator on all of the time. The EN input must not be left floating.

reverse current path

The power transistor used in the TPS760xx has an inherent diode connected between IN and OUT as shown in the functional block diagram. This diode conducts current from the OUT terminal to the IN terminal whenever IN is lower than OUT by a diode drop. This condition does not damage the TPS760xx, provided the current is limited to 100 mA.

PACKAGING INFORMATION

Orderable Device	Status (1)	Package Type	Package Drawing	Pins	Package Qty	Eco Plan (2)	Lead/Ball Finish (6)	MSL Peak Temp (3)	Op Temp (°C)	Device Marking (4/5)	Samples
TPS76030DBVR	ACTIVE	SOT-23	DBV	5	3000	Green (RoHS & no Sb/Br)	CU NIPDAU	Level-1-260C-UNLIM	-40 to 125	PAGI	Samples
TPS76030DBVRG4	ACTIVE	SOT-23	DBV	5	3000	Green (RoHS & no Sb/Br)	CU NIPDAU	Level-1-260C-UNLIM	-40 to 125	PAGI	Samples
TPS76030DBVT	ACTIVE	SOT-23	DBV	5	250	Green (RoHS & no Sb/Br)	CU NIPDAU	Level-1-260C-UNLIM	-40 to 125	PAGI	Samples
TPS76030DBVTG4	ACTIVE	SOT-23	DBV	5	250	Green (RoHS & no Sb/Br)	CU NIPDAU	Level-1-260C-UNLIM	-40 to 125	PAGI	Samples
TPS76032DBVR	ACTIVE	SOT-23	DBV	5	3000	Green (RoHS & no Sb/Br)	CU NIPDAU	Level-1-260C-UNLIM	-40 to 125	PAOI	Samples
TPS76032DBVRG4	ACTIVE	SOT-23	DBV	5	3000	Green (RoHS & no Sb/Br)	CU NIPDAU	Level-1-260C-UNLIM	-40 to 125	PAOI	Samples
TPS76033DBVR	ACTIVE	SOT-23	DBV	5	3000	Green (RoHS & no Sb/Br)	CU NIPDAU	Level-1-260C-UNLIM	-40 to 125	PAHI	Samples
TPS76033DBVRG4	ACTIVE	SOT-23	DBV	5	3000	Green (RoHS & no Sb/Br)	CU NIPDAU	Level-1-260C-UNLIM	-40 to 125	PAHI	Samples
TPS76033DBVT	ACTIVE	SOT-23	DBV	5	250	Green (RoHS & no Sb/Br)	CU NIPDAU	Level-1-260C-UNLIM	-40 to 125	PAHI	Samples
TPS76033DBVTG4	ACTIVE	SOT-23	DBV	5	250	Green (RoHS & no Sb/Br)	CU NIPDAU	Level-1-260C-UNLIM	-40 to 125	PAHI	Samples
TPS76038DBVR	ACTIVE	SOT-23	DBV	5	3000	Green (RoHS & no Sb/Br)	CU NIPDAU	Level-1-260C-UNLIM	-40 to 125	PAJI	Samples
TPS76038DBVRG4	ACTIVE	SOT-23	DBV	5	3000	Green (RoHS & no Sb/Br)	CU NIPDAU	Level-1-260C-UNLIM	-40 to 125	PAJI	Samples
TPS76038DBVT	ACTIVE	SOT-23	DBV	5	250	Green (RoHS & no Sb/Br)	CU NIPDAU	Level-1-260C-UNLIM	-40 to 125	PAJI	Samples
TPS76038DBVTG4	ACTIVE	SOT-23	DBV	5	250	Green (RoHS & no Sb/Br)	CU NIPDAU	Level-1-260C-UNLIM	-40 to 125	PAJI	Samples
TPS76050DBVR	ACTIVE	SOT-23	DBV	5	3000	Green (RoHS & no Sb/Br)	CU NIPDAU	Level-1-260C-UNLIM	-40 to 125	PANI	Samples
TPS76050DBVRG4	ACTIVE	SOT-23	DBV	5	3000	Green (RoHS & no Sb/Br)	CU NIPDAU	Level-1-260C-UNLIM	-40 to 125	PANI	Samples
TPS76050DBVT	ACTIVE	SOT-23	DBV	5	250	Green (RoHS & no Sb/Br)	CU NIPDAU	Level-1-260C-UNLIM	-40 to 125	PANI	Samples

Orderable Device	Status (1)	Package Type	Package Drawing	Pins	Package Qty	Eco Plan (2)	Lead/Ball Finish (6)	MSL Peak Temp (3)	Op Temp (°C)	Device Marking (4/5)	Samples
TPS76050DBVTG4	ACTIVE	SOT-23	DBV	5	250	Green (RoHS & no Sb/Br)	CU NIPDAU	Level-1-260C-UNLIM	-40 to 125	PANI	Samples

(1) The marketing status values are defined as follows:

ACTIVE: Product device recommended for new designs.

LIFEBUY: TI has announced that the device will be discontinued, and a lifetime-buy period is in effect.

NRND: Not recommended for new designs. Device is in production to support existing customers, but TI does not recommend using this part in a new design.

PREVIEW: Device has been announced but is not in production. Samples may or may not be available.

OBSOLETE: TI has discontinued the production of the device.

(2) Eco Plan - The planned eco-friendly classification: Pb-Free (RoHS), Pb-Free (RoHS Exempt), or Green (RoHS & no Sb/Br) - please check <http://www.ti.com/productcontent> for the latest availability information and additional product content details.

TBD: The Pb-Free/Green conversion plan has not been defined.

Pb-Free (RoHS): TI's terms "Lead-Free" or "Pb-Free" mean semiconductor products that are compatible with the current RoHS requirements for all 6 substances, including the requirement that lead not exceed 0.1% by weight in homogeneous materials. Where designed to be soldered at high temperatures, TI Pb-Free products are suitable for use in specified lead-free processes.

Pb-Free (RoHS Exempt): This component has a RoHS exemption for either 1) lead-based flip-chip solder bumps used between the die and package, or 2) lead-based die adhesive used between the die and leadframe. The component is otherwise considered Pb-Free (RoHS compatible) as defined above.

Green (RoHS & no Sb/Br): TI defines "Green" to mean Pb-Free (RoHS compatible), and free of Bromine (Br) and Antimony (Sb) based flame retardants (Br or Sb do not exceed 0.1% by weight in homogeneous material)

(3) MSL, Peak Temp. - The Moisture Sensitivity Level rating according to the JEDEC industry standard classifications, and peak solder temperature.

(4) There may be additional marking, which relates to the logo, the lot trace code information, or the environmental category on the device.

(5) Multiple Device Markings will be inside parentheses. Only one Device Marking contained in parentheses and separated by a "~" will appear on a device. If a line is indented then it is a continuation of the previous line and the two combined represent the entire Device Marking for that device.

(6) Lead/Ball Finish - Orderable Devices may have multiple material finish options. Finish options are separated by a vertical ruled line. Lead/Ball Finish values may wrap to two lines if the finish value exceeds the maximum column width.

Important Information and Disclaimer: The information provided on this page represents TI's knowledge and belief as of the date that it is provided. TI bases its knowledge and belief on information provided by third parties, and makes no representation or warranty as to the accuracy of such information. Efforts are underway to better integrate information from third parties. TI has taken and continues to take reasonable steps to provide representative and accurate information but may not have conducted destructive testing or chemical analysis on incoming materials and chemicals. TI and TI suppliers consider certain information to be proprietary, and thus CAS numbers and other limited information may not be available for release.

In no event shall TI's liability arising out of such information exceed the total purchase price of the TI part(s) at issue in this document sold by TI to Customer on an annual basis.

TAPE AND REEL INFORMATION
REEL DIMENSIONS

TAPE DIMENSIONS

A0	Dimension designed to accommodate the component width
B0	Dimension designed to accommodate the component length
K0	Dimension designed to accommodate the component thickness
W	Overall width of the carrier tape
P1	Pitch between successive cavity centers

TAPE AND REEL INFORMATION

*All dimensions are nominal

Device	Package Type	Package Drawing	Pins	SPQ	Reel Diameter (mm)	Reel Width W1 (mm)	A0 (mm)	B0 (mm)	K0 (mm)	P1 (mm)	W (mm)	Pin1 Quadrant
TPS76030DBVR	SOT-23	DBV	5	3000	180.0	9.0	3.15	3.2	1.4	4.0	8.0	Q3
TPS76030DBVT	SOT-23	DBV	5	250	180.0	9.0	3.15	3.2	1.4	4.0	8.0	Q3
TPS76032DBVR	SOT-23	DBV	5	3000	180.0	9.0	3.15	3.2	1.4	4.0	8.0	Q3
TPS76033DBVR	SOT-23	DBV	5	3000	178.0	9.0	3.23	3.17	1.37	4.0	8.0	Q3
TPS76033DBVT	SOT-23	DBV	5	250	178.0	9.0	3.23	3.17	1.37	4.0	8.0	Q3
TPS76038DBVR	SOT-23	DBV	5	3000	180.0	9.0	3.15	3.2	1.4	4.0	8.0	Q3
TPS76038DBVT	SOT-23	DBV	5	250	180.0	9.0	3.15	3.2	1.4	4.0	8.0	Q3
TPS76050DBVR	SOT-23	DBV	5	3000	178.0	9.0	3.23	3.17	1.37	4.0	8.0	Q3
TPS76050DBVT	SOT-23	DBV	5	250	178.0	9.0	3.23	3.17	1.37	4.0	8.0	Q3

TAPE AND REEL BOX DIMENSIONS

*All dimensions are nominal

Device	Package Type	Package Drawing	Pins	SPQ	Length (mm)	Width (mm)	Height (mm)
TPS76030DBVR	SOT-23	DBV	5	3000	182.0	182.0	20.0
TPS76030DBVT	SOT-23	DBV	5	250	182.0	182.0	20.0
TPS76032DBVR	SOT-23	DBV	5	3000	182.0	182.0	20.0
TPS76033DBVR	SOT-23	DBV	5	3000	180.0	180.0	18.0
TPS76033DBVT	SOT-23	DBV	5	250	180.0	180.0	18.0
TPS76038DBVR	SOT-23	DBV	5	3000	182.0	182.0	20.0
TPS76038DBVT	SOT-23	DBV	5	250	182.0	182.0	20.0
TPS76050DBVR	SOT-23	DBV	5	3000	180.0	180.0	18.0
TPS76050DBVT	SOT-23	DBV	5	250	180.0	180.0	18.0

DBV (R-PDSO-G5)

PLASTIC SMALL-OUTLINE PACKAGE



- NOTES:
- A. All linear dimensions are in millimeters.
 - B. This drawing is subject to change without notice.
 - C. Body dimensions do not include mold flash or protrusion. Mold flash and protrusion shall not exceed 0.15 per side.
 - D. Falls within JEDEC MO-178 Variation AA.

DBV (R-PDSO-G5)

PLASTIC SMALL OUTLINE



- NOTES:
- A. All linear dimensions are in millimeters.
 - B. This drawing is subject to change without notice.
 - C. Customers should place a note on the circuit board fabrication drawing not to alter the center solder mask defined pad.
 - D. Publication IPC-7351 is recommended for alternate designs.
 - E. Laser cutting apertures with trapezoidal walls and also rounding corners will offer better paste release. Customers should contact their board assembly site for stencil design recommendations. Example stencil design based on a 50% volumetric metal load solder paste. Refer to IPC-7525 for other stencil recommendations.

IMPORTANT NOTICE

Texas Instruments Incorporated and its subsidiaries (TI) reserve the right to make corrections, enhancements, improvements and other changes to its semiconductor products and services per JESD46, latest issue, and to discontinue any product or service per JESD48, latest issue. Buyers should obtain the latest relevant information before placing orders and should verify that such information is current and complete. All semiconductor products (also referred to herein as "components") are sold subject to TI's terms and conditions of sale supplied at the time of order acknowledgment.

TI warrants performance of its components to the specifications applicable at the time of sale, in accordance with the warranty in TI's terms and conditions of sale of semiconductor products. Testing and other quality control techniques are used to the extent TI deems necessary to support this warranty. Except where mandated by applicable law, testing of all parameters of each component is not necessarily performed.

TI assumes no liability for applications assistance or the design of Buyers' products. Buyers are responsible for their products and applications using TI components. To minimize the risks associated with Buyers' products and applications, Buyers should provide adequate design and operating safeguards.

TI does not warrant or represent that any license, either express or implied, is granted under any patent right, copyright, mask work right, or other intellectual property right relating to any combination, machine, or process in which TI components or services are used. Information published by TI regarding third-party products or services does not constitute a license to use such products or services or a warranty or endorsement thereof. Use of such information may require a license from a third party under the patents or other intellectual property of the third party, or a license from TI under the patents or other intellectual property of TI.

Reproduction of significant portions of TI information in TI data books or data sheets is permissible only if reproduction is without alteration and is accompanied by all associated warranties, conditions, limitations, and notices. TI is not responsible or liable for such altered documentation. Information of third parties may be subject to additional restrictions.

Resale of TI components or services with statements different from or beyond the parameters stated by TI for that component or service voids all express and any implied warranties for the associated TI component or service and is an unfair and deceptive business practice. TI is not responsible or liable for any such statements.

Buyer acknowledges and agrees that it is solely responsible for compliance with all legal, regulatory and safety-related requirements concerning its products, and any use of TI components in its applications, notwithstanding any applications-related information or support that may be provided by TI. Buyer represents and agrees that it has all the necessary expertise to create and implement safeguards which anticipate dangerous consequences of failures, monitor failures and their consequences, lessen the likelihood of failures that might cause harm and take appropriate remedial actions. Buyer will fully indemnify TI and its representatives against any damages arising out of the use of any TI components in safety-critical applications.

In some cases, TI components may be promoted specifically to facilitate safety-related applications. With such components, TI's goal is to help enable customers to design and create their own end-product solutions that meet applicable functional safety standards and requirements. Nonetheless, such components are subject to these terms.

No TI components are authorized for use in FDA Class III (or similar life-critical medical equipment) unless authorized officers of the parties have executed a special agreement specifically governing such use.

Only those TI components which TI has specifically designated as military grade or "enhanced plastic" are designed and intended for use in military/aerospace applications or environments. Buyer acknowledges and agrees that any military or aerospace use of TI components which have **not** been so designated is solely at the Buyer's risk, and that Buyer is solely responsible for compliance with all legal and regulatory requirements in connection with such use.

TI has specifically designated certain components as meeting ISO/TS16949 requirements, mainly for automotive use. In any case of use of non-designated products, TI will not be responsible for any failure to meet ISO/TS16949.

Products

Audio	www.ti.com/audio
Amplifiers	amplifier.ti.com
Data Converters	dataconverter.ti.com
DLP® Products	www.dlp.com
DSP	dsp.ti.com
Clocks and Timers	www.ti.com/clocks
Interface	interface.ti.com
Logic	logic.ti.com
Power Mgmt	power.ti.com
Microcontrollers	microcontroller.ti.com
RFID	www.ti-rfid.com
OMAP Applications Processors	www.ti.com/omap
Wireless Connectivity	www.ti.com/wirelessconnectivity

Applications

Automotive and Transportation	www.ti.com/automotive
Communications and Telecom	www.ti.com/communications
Computers and Peripherals	www.ti.com/computers
Consumer Electronics	www.ti.com/consumer-apps
Energy and Lighting	www.ti.com/energy
Industrial	www.ti.com/industrial
Medical	www.ti.com/medical
Security	www.ti.com/security
Space, Avionics and Defense	www.ti.com/space-avionics-defense
Video and Imaging	www.ti.com/video

TI E2E Community

e2e.ti.com