

# CD4067B, CD4097B Types

## CMOS Analog Multiplexers/Demultiplexers

High-Voltage Types (20-Volt Rating)

CD4067B - Single 16-Channel Multiplexer/Demultiplexer

CD4097B - Differential 8-Channel Multiplexer/Demultiplexer

**CD4067B and CD4097B CMOS**

analog multiplexers/demultiplexers\* are digitally controlled analog switches having low ON impedance, low OFF leakage current, and internal address decoding. In addition, the ON resistance is relatively constant over the full input-signal range.

The CD4067B is a 16-channel multiplexer with four binary control inputs, A, B, C, D, and an inhibit input, arranged so that any combination of the inputs selects one switch.

The CD4097B is a differential 8-channel multiplexer having three binary control inputs A, B, C, and an inhibit input. The inputs permit selection of one of eight pairs of switches.

A logic "1" present at the inhibit input turns all channels off.

The CD4067B and CD4097B types are supplied in 24-lead hermetic dual-in-line ceramic packages (F3A suffix), 24-lead dual-in-line plastic packages (E suffix), 24-lead small-outline packages (M, M96, and NSR suffixes), and 24-lead thin shrink small-outline packages (P and PWR suffixes).

\*When these devices are used as demultiplexers, the channel in/out terminals are the outputs and the common out/in terminals are the inputs.

**Recommended Operating Conditions at T<sub>A</sub> = 25°C (Unless Otherwise Specified)**

For maximum reliability, nominal operating conditions should be selected so that operation is always within the following ranges. Values shown apply to all types except as noted.

Characteristic	Min.	Max.	Units
Supply-Voltage Range (T <sub>A</sub> =Full Package-Temp. Range)	3	18	V
Multiplexer Switch Input Current Capability	-	25	mA
Output Load Resistance	100	-	Ω

**NOTE:**

In certain applications, the external load-resistor current may include both V<sub>DD</sub> and signal-line components. To avoid drawing V<sub>DD</sub> current when switch current flows into the transmission gate inputs, the voltage drop across the bidirectional switch must not exceed 0.8 volt (calculated from R<sub>ON</sub> values shown in ELECTRICAL CHARACTERISTICS CHART). No V<sub>DD</sub> current will flow through R<sub>L</sub> if the switch current flows into terminal 1 on the CD4067; terminals 1 and 17 on the CD4097.

**Features:**

- Low ON resistance: 125 Ω (typ.) over 15 V<sub>pp</sub> signal-input range for V<sub>DD</sub>-V<sub>SS</sub>=15 V
- High OFF resistance: channel leakage of ±10 pA (typ.) @ V<sub>DD</sub>-V<sub>SS</sub>=10 V
- Matched switch characteristics: R<sub>ON</sub>=5 Ω (typ.) for V<sub>DD</sub>-V<sub>SS</sub>=15 V
- Very low quiescent power dissipation under all digital-control input and supply conditions: 0.2 μW (typ.) @ V<sub>DD</sub>-V<sub>SS</sub>=10 V
- Binary address decoding on chip
- 5-V, 10-V, and 15-V parametric ratings
- 100% tested for quiescent current at 20 V
- Standardized symmetrical output characteristics
- Maximum input current of 1 μA at 18 V over full package temperature range; 100 nA at 18 V and 25°C
- Meets all requirements of JEDEC Tentative Standard No. 13B, "Standard Specifications for Description of 'B' Series CMOS Devices"

**Applications:**

- Analog and digital multiplexing and demultiplexing
- A/D and D/A conversion
- Signal gating

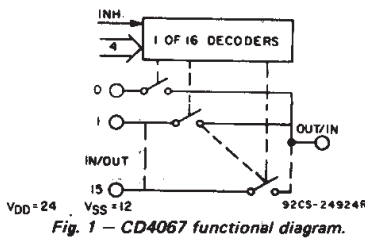
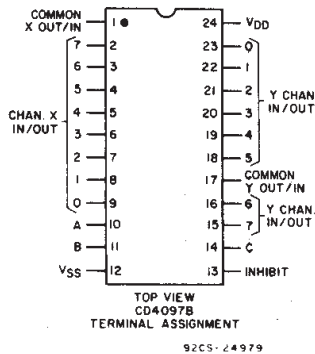
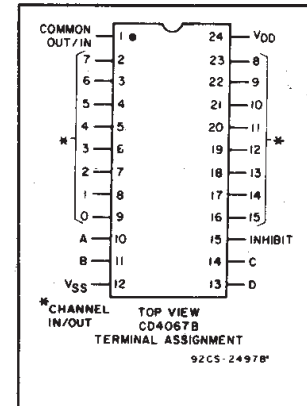

Fig. 1 - CD4067 functional diagram.

**CD4067 TRUTH TABLE**

A	B	C	D	Inh	Selected Channel
X	X	X	X	1	None
0	0	0	0	0	0
1	0	0	0	0	1
0	1	0	0	0	2
1	1	0	0	0	3
0	0	1	0	0	4
1	0	1	0	0	5
0	1	1	0	0	6
1	1	1	0	0	7
0	0	0	1	0	8
1	0	0	1	0	9
0	1	0	1	0	10
1	1	0	1	0	11
0	0	1	1	0	12
1	0	1	1	0	13
0	1	1	1	0	14
1	1	1	1	0	15

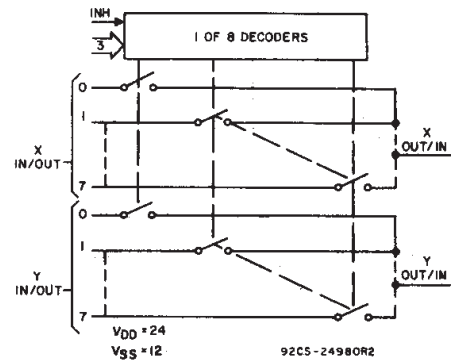

Fig. 2 - CD4097 functional diagram.

**CD4097 TRUTH TABLE**

A	B	C	Inh	Selected Channel
X	X	X	1	None
0	0	0	0	0X, 0Y
1	0	0	0	1X, 1Y
0	1	0	0	2X, 2Y
1	1	0	0	3X, 3Y
0	0	1	0	4X, 4Y
1	0	1	0	5X, 5Y
0	1	1	0	6X, 6Y
1	1	1	0	7X, 7Y

**3**  
COMMERCIAL CMOS  
HIGH VOLTAGE ICs

# CD4067B, CD4097B Types

## ELECTRICAL CHARACTERISTICS

CHARACTERISTIC	CONDITIONS			LIMITS AT INDICATED TEMPERATURES (°C)						Units	
	$V_{is}$ (V)	$V_{SS}$ (V)	$V_{DD}$ (V)	-55	-40	+85	+125	+25			
								Min.	Typ.		Max.
<b>SIGNAL INPUTS (<math>V_{is}</math>) AND OUTPUTS (<math>V_{OS}</math>)</b>											
Quiescent Device Current, $I_{DD}$ Max.			5	5	5	150	150	—	0.04	5	$\mu A$
			10	10	10	300	300	—	0.04	10	
			15	20	20	600	600	—	0.04	20	
			20	100	100	3000	3000	—	0.08	100	
ON-state Resistance $V_{SS} \leq V_{is} \leq V_{DD}$ $r_{on}$ Max.		0	5	800	850	1200	1300	—	470	1050	$\Omega$
		0	10	310	330	520	550	—	180	400	
		0	15	200	210	300	320	—	125	240	
Change in on-state Resistance (Between Any Two Channels) $\Delta r_{on}$		0	5	—	—	—	—	—	15	—	$\Omega$
		0	10	—	—	—	—	—	10	—	
		0	15	—	—	—	—	—	5	—	
OFF Channel Leakage Current: Any Channel OFF (Common OUT/IN) Max. or All Channels OFF		0	18	$\pm 100^*$		$\pm 1000^*$			$\pm 0.1$	$\pm 100^*$	nA
Capacitance: Input, $C_{is}$ Output, $C_{os}$ CD4067 CD4097 Feed-through, $C_{ios}$				—	—	—	—	—	5	—	pF
		-5	5	—	—	—	—	—	55	—	
				—	—	—	—	—	35	—	
Propagation Delay Time (Signal Input to Output)	$V_{DD}$ 	$R_L = 200 K\Omega$ $C_L = 50 pF$ $t_r, t_f = 20 ns$	5	—	—	—	—	—	30	60	ns
			10	—	—	—	—	—	15	30	
			15	—	—	—	—	—	10	20	
<b>CONTROL (ADDRESS or INHIBIT) <math>V_C</math></b>											
Input Low Voltage, $V_{IL}$ Max.	$=V_{DD}$ thru $1 K\Omega$	$R_L = 1 K\Omega$ to $V_{SS}$ $I_{IS} < 2 \mu A$ on all OFF Channels	5	1.5	—	—	—	—	—	1.5	V
			10	3	—	—	—	—	3		
			15	4	—	—	—	—	4		
Input High Voltage, $V_{IH}$ Min.	$=V_{DD}$ thru $1 K\Omega$	$R_L = 1 K\Omega$ to $V_{SS}$ $I_{IS} < 2 \mu A$ on all OFF Channels	5	3.5	3.5	—	—	—	—	—	
			10	7	7	—	—	—	—		
			15	11	11	—	—	—	—		

\* Determined by minimum feasible leakage measurement for automatic testing.

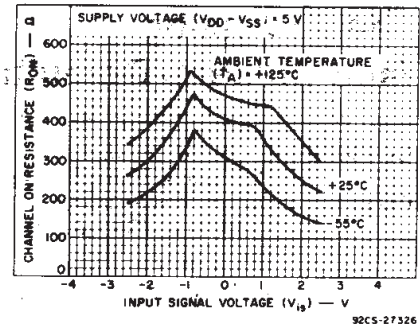

Fig. 3—Typical ON resistance vs. input signal voltage (all types).

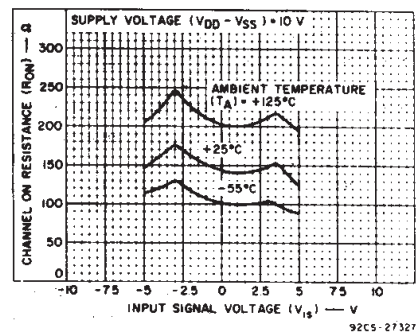

Fig. 4—Typical ON resistance vs. input signal voltage (all types).

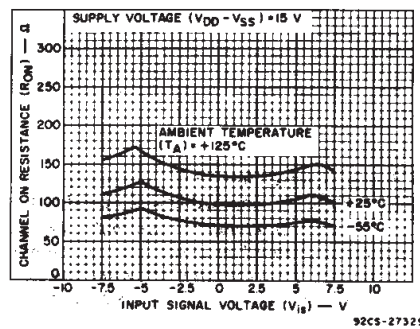

Fig. 5—Typical ON resistance vs. input signal voltage (all types).

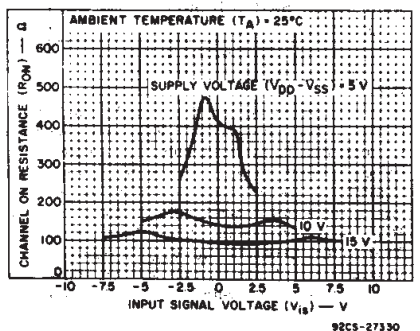

Fig. 6—Typical ON resistance vs. input signal voltage (all types).

# CD4067B, CD4097B Types

## ELECTRICAL CHARACTERISTICS (Cont'd)

CHARACTERISTIC	CONDITIONS			LIMITS AT INDICATED TEMPERATURES (°C)							Units
	V <sub>is</sub> (V)	V <sub>SS</sub> (V)	V <sub>DD</sub> (V)	-55	-40	+85	+125	+25			
								Min.	Typ.	Max.	
Input Current, I <sub>IN</sub> Max.	V <sub>IN</sub> = 0, 18 V			±0.1	±0.1	±1	±1	—	±10 <sup>-5</sup>	±0.1	μA
Propagation Delay Time: Address or Inhibit-to-Signal OUT (Channel turning ON)	R <sub>L</sub> = 10 KΩ, C <sub>L</sub> = 50 pF, t <sub>r</sub> , t <sub>f</sub> = 20 ns			—	—	—	—	—	325	650	ns
	0	5	—	—	—	—	—	—	135	270	
	0	10	—	—	—	—	—	—	95	190	
Address or Inhibit-to-Signal OUT (Channel turning OFF)	R <sub>L</sub> = 300 Ω, C <sub>L</sub> = 50 pF, t <sub>r</sub> , t <sub>f</sub> = 20 ns			—	—	—	—	—	220	440	ns
	0	5	—	—	—	—	—	—	90	180	
	0	15	—	—	—	—	—	—	65	130	
Input Capacitance, C <sub>IN</sub>	Any Address or Inhibit Input			—	—	—	—	—	5	7.5	pF

## TEST CIRCUITS

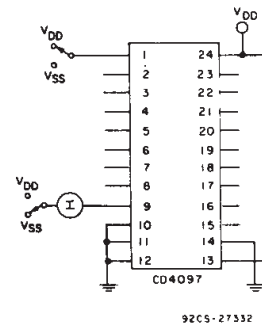
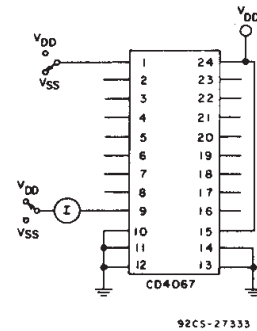

Fig. 7—OFF channel leakage current—any channel OFF.

## MAXIMUM RATINGS, Absolute-Maximum Values:

- DC SUPPLY-VOLTAGE RANGE, (V<sub>DD</sub>)  
Voltages referenced to V<sub>SS</sub> Terminal) ..... -0.5V to +20V
- INPUT VOLTAGE RANGE, ALL INPUTS ..... -0.5V to V<sub>DD</sub> +0.5V
- DC INPUT CURRENT, ANY ONE INPUT ..... ±10mA
- POWER DISSIPATION PER PACKAGE (P<sub>D</sub>):  
For T<sub>A</sub> = -55°C to +100°C ..... 500mW  
For T<sub>A</sub> = +100°C to +125°C ..... Derate Linearly at 12mW/°C to 200mW
- DEVICE DISSIPATION PER OUTPUT TRANSISTOR  
FOR T<sub>A</sub> = FULL PACKAGE-TEMPERATURE RANGE (All Package Types) ..... 100mW
- OPERATING-TEMPERATURE RANGE (T<sub>A</sub>) ..... -55°C to +125°C
- STORAGE TEMPERATURE RANGE (T<sub>stg</sub>) ..... -65°C to +150°C
- LEAD TEMPERATURE (DURING SOLDERING):  
At distance 1/16 ± 1/32 inch (1.59 ± 0.79mm) from case for 10s max ..... +265°C

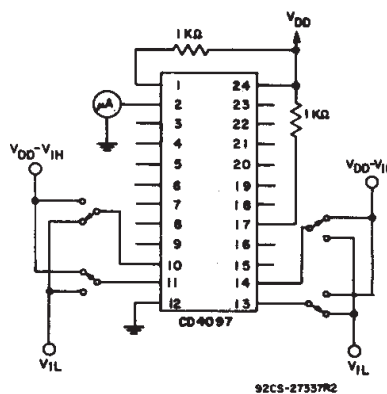
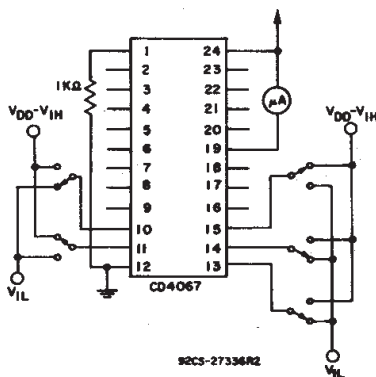

Fig. 8—Input voltage—measure < 2 μA on all OFF channels (e.g., channel 12).

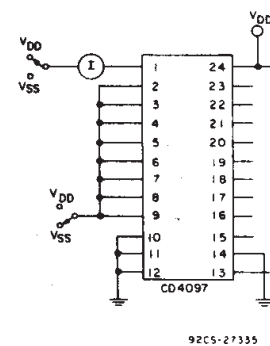
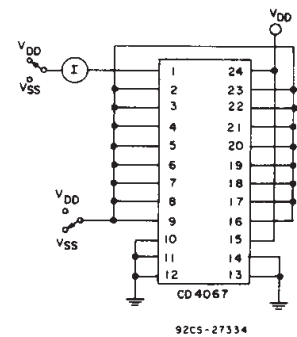

Fig. 9—OFF channel leakage current—all channels OFF.

3  
COMMERCIAL CMOS  
HIGH VOLTAGE ICs

# CD4067B, CD4097B Types

## ELECTRICAL CHARACTERISTICS (Cont'd)

CHARACTERISTIC	TEST CONDITIONS			TYPICAL VALUES	UNITS			
	V <sub>is</sub> (V)	V <sub>DD</sub> (V)	R <sub>L</sub> (KΩ)					
Cutoff (-3 dB) Frequency Channel ON (Sine Wave Input)	5 <sup>●</sup>	10	1	CD4067	14	MHz		
	20 log $\frac{V_{os}}{V_{is}} = -3$ dB			CD4097	20			
Total Harmonic Distortion, THD	f <sub>is</sub> = 1 kHz sine wave			V <sub>os</sub> at Common OUT/IN		%		
				V <sub>os</sub> at Any Channel			60	
				2 <sup>●</sup>	5		10	0.3
				3 <sup>●</sup>	10			0.2
5 <sup>●</sup>	15	0.12						
-40 dB Feedthrough Frequency (All Channels OFF)	5 <sup>●</sup>	10	1	CD4067	20	MHz		
	20 log $\frac{V_{os}}{V_{is}} = -40$ dB			CD4097	12			
Signal Crosstalk (Frequency at -40 dB)	5 <sup>●</sup>	10	1	Between Any 2 Channels <sup>▲</sup>		1	MHz	
	20 log $\frac{V_{os}}{V_{is}} = -40$ dB			Between Sections CD4097 Only	Measured on Common	10		
					Measured on Any Channel	18		
Address-or-Inhibit-to-Signal Crosstalk	V <sub>SS</sub> =0, t <sub>r</sub> , t <sub>f</sub> =20 ns, V <sub>C</sub> =V <sub>DD</sub> -V <sub>SS</sub> (Square Wave)					75	mV (Peak)	

● Peak-to-peak voltage symmetrical about  $\frac{V_{DD}-V_{SS}}{2}$ .

▲ Worst case.

\* Both ends of channel.

## TEST CIRCUITS (Cont'd)

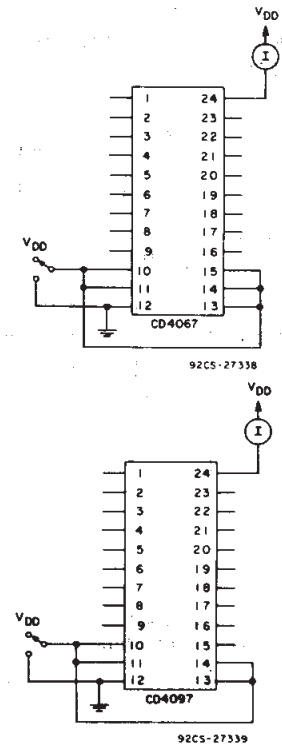

Fig. 10—Quiescent device current.

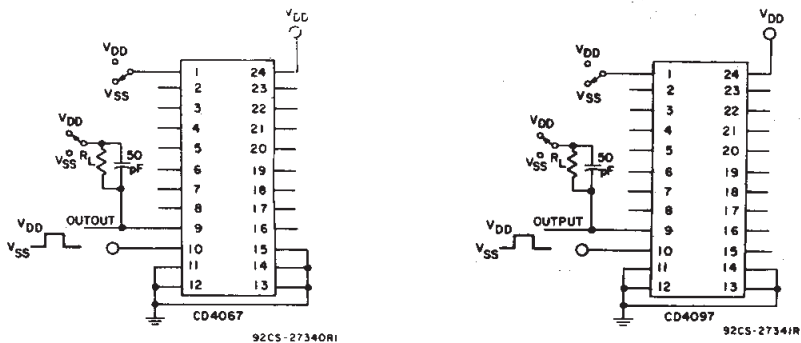

Fig. 11—Turn-on and turn-off propagation delay—address select input to signal output (e.g. measured on channel 0).

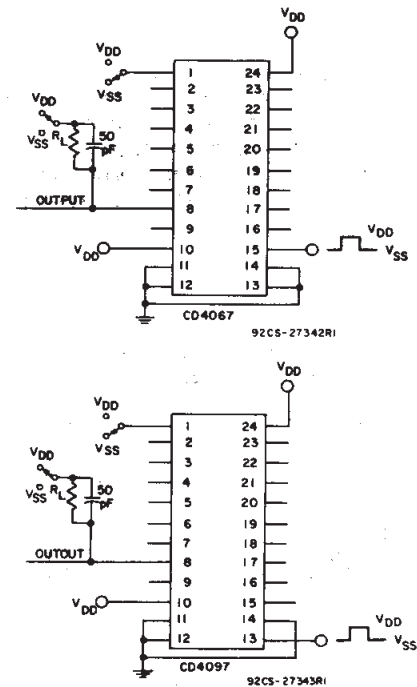

Fig. 12—Turn-on and turn-off propagation delay—  
inhibit input to signal output (e.g. measured on channel 1).

# CD4067B, CD4097B Types

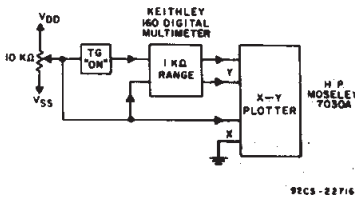

Fig. 13- Channel ON resistance measurement circuit.

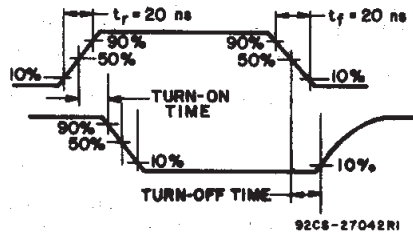

Fig. 14- Propagation delay waveform channel being turned ON ( $R_L = 10\text{ K}\Omega$ ,  $C_L = 50\text{ pF}$ ).

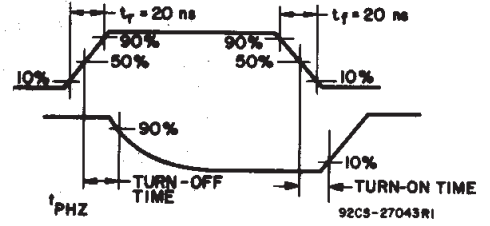

Fig. 15- Propagation delay waveform, channel being turned OFF ( $R_L = 300\Omega$ ,  $C_L = 50\text{ pF}$ ).

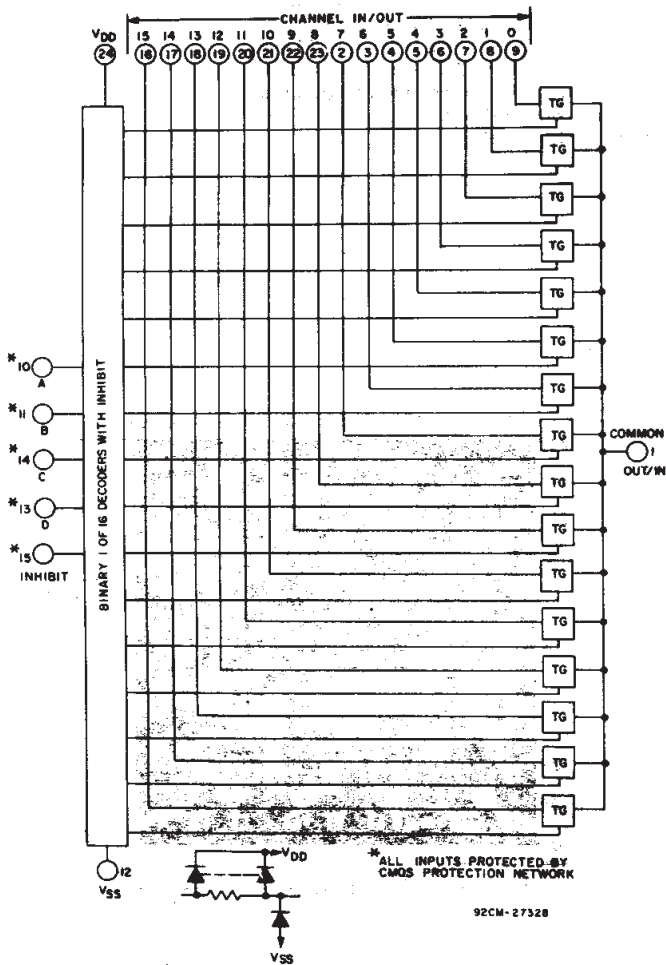

Fig. 16- CD4067 logic diagram.

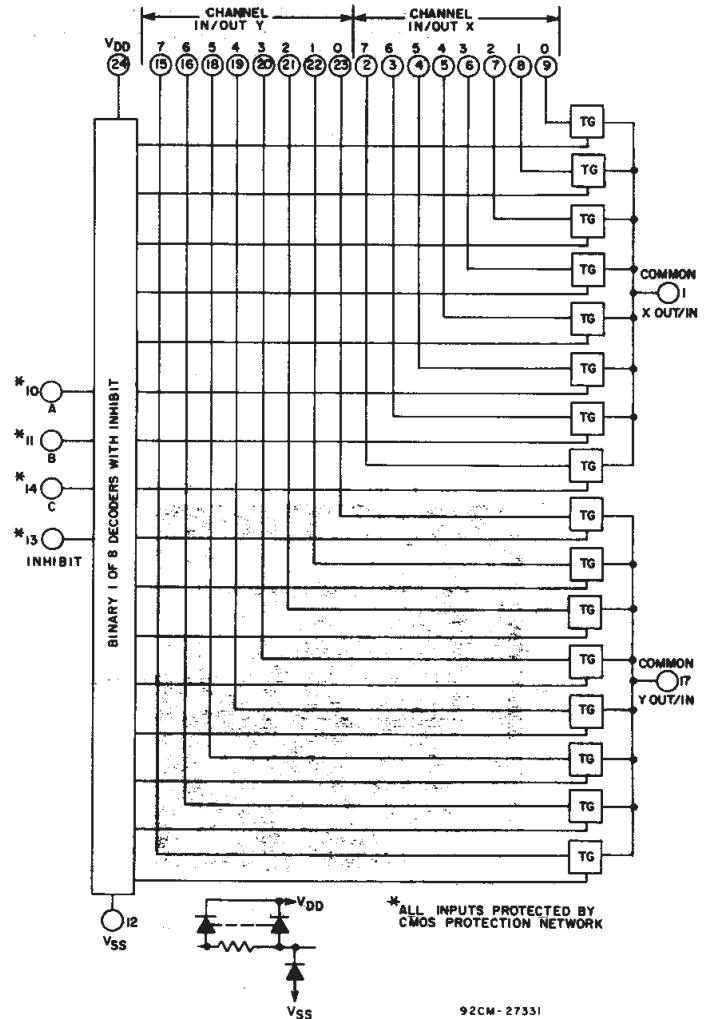

Fig. 17- CD4097 logic diagram.

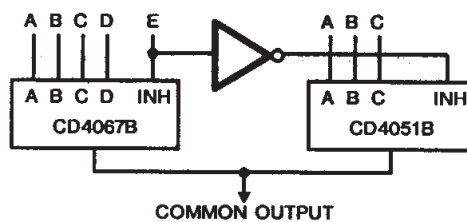

Fig. 18-24-to-1 MUX Addressing

3  
COMMERCIAL CMOS  
HIGH VOLTAGE ICs

## CD4067B, CD4097B Types

### SPECIAL CONSIDERATIONS

In applications where separate power sources are used to drive  $V_{DD}$  and the signal inputs, the  $V_{DD}$  current capability should exceed  $V_{DD}/R_L$  ( $R_L$ =effective external load). This provision avoids permanent current flow or clamp action on the  $V_{DD}$  supply when power is applied or removed from the CD4067B or CD4097B.

When switching from one address to another, some of the ON periods of the channels of the multiplexers will overlap momentarily, which may be objectionable in certain applications. Also when a channel is turned on or off by an address input, there is a momentary conductive path from the channel to  $V_{SS}$ , which will dump some charge from any capacitor connected to the input or output of the channel. The inhibit input turning on a channel will similarly dump some charge to  $V_{SS}$ .

The amount of charge dumped is mostly a function of the signal level above  $V_{SS}$ . Typically, at  $V_{DD}-V_{SS}=10$  V, a 100-pF

capacitor connected to the input or output of the channel will lose 3-4% of its voltage at the moment the channel turns on or off. This loss of voltage is essentially independent of the address or inhibit signal transition time, if the transition time is less than 1-2  $\mu$ s. When the inhibit signal turns a channel off, there is no charge dumping to  $V_{SS}$ . Rather, there is a slight rise in the channel voltage level (65 mV typ.) due to capacitive coupling from inhibit input to channel input or output. Address inputs also couple some voltage steps onto the channel signal levels.

In certain applications, the external load-resistor current may include both  $V_{DD}$  and signal-line components. To avoid drawing  $V_{DD}$  current when switch current flows into the transmission gate inputs, the voltage drop across the bidirectional switch must not exceed 0.8 volt (calculated from  $R_{ON}$  values shown in ELECTRICAL CHARACTERISTICS CHART). No  $V_{DD}$  current will flow through  $R_L$  if the switch current flows into terminal 1 on the CD4067B, terminals 1 and 17 on the CD4097B.

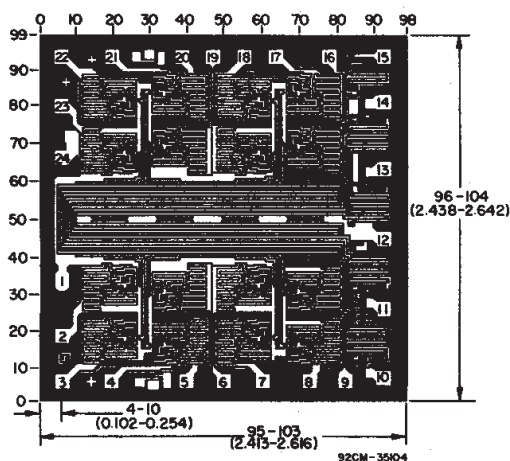

Dimensions and pad layout for CD4067BH.

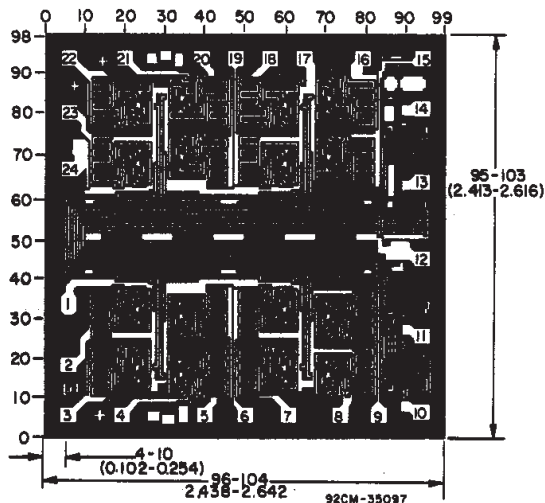



Dimensions and pad layout for CD4097BH.

Dimensions in parentheses are in millimeters and are derived from the basic inch dimensions as indicated. Grid graduations are in mils ( $10^{-3}$  inch).



**PACKAGING INFORMATION**

Orderable Device	Status (1)	Package Type	Package Drawing	Pins	Package Qty	Eco Plan (2)	Lead/Ball Finish (6)	MSL Peak Temp (3)	Op Temp (°C)	Device Marking (4/5)	Samples
CD4067BE	ACTIVE	PDIP	N	24	15	Pb-Free (RoHS)	CU NIPDAU	N / A for Pkg Type	-55 to 125	CD4067BE	<a href="#">Samples</a>
CD4067BEE4	ACTIVE	PDIP	N	24	15	Pb-Free (RoHS)	CU NIPDAU	N / A for Pkg Type	-55 to 125	CD4067BE	<a href="#">Samples</a>
CD4067BF	ACTIVE	CDIP	J	24	1	TBD	Call TI	N / A for Pkg Type	-55 to 125	CD4067BF	<a href="#">Samples</a>
CD4067BF3A	ACTIVE	CDIP	J	24	1	TBD	Call TI	N / A for Pkg Type	-55 to 125	CD4067BF3A	<a href="#">Samples</a>
CD4067BM	ACTIVE	SOIC	DW	24	25	Green (RoHS & no Sb/Br)	CU NIPDAU	Level-1-260C-UNLIM	-55 to 125	CD4067BM	<a href="#">Samples</a>
CD4067BM96	ACTIVE	SOIC	DW	24	2000	Green (RoHS & no Sb/Br)	CU NIPDAU	Level-1-260C-UNLIM	-55 to 125	CD4067BM	<a href="#">Samples</a>
CD4067BM96E4	ACTIVE	SOIC	DW	24	2000	Green (RoHS & no Sb/Br)	CU NIPDAU	Level-1-260C-UNLIM	-55 to 125	CD4067BM	<a href="#">Samples</a>
CD4067BM96G4	ACTIVE	SOIC	DW	24	2000	Green (RoHS & no Sb/Br)	CU NIPDAU	Level-1-260C-UNLIM	-55 to 125	CD4067BM	<a href="#">Samples</a>
CD4067BME4	ACTIVE	SOIC	DW	24	25	Green (RoHS & no Sb/Br)	CU NIPDAU	Level-1-260C-UNLIM	-55 to 125	CD4067BM	<a href="#">Samples</a>
CD4067BPW	ACTIVE	TSSOP	PW	24	60	Green (RoHS & no Sb/Br)	CU NIPDAU	Level-1-260C-UNLIM	-55 to 125	CM067B	<a href="#">Samples</a>
CD4067BPWG4	ACTIVE	TSSOP	PW	24	60	Green (RoHS & no Sb/Br)	CU NIPDAU	Level-1-260C-UNLIM	-55 to 125	CM067B	<a href="#">Samples</a>
CD4097BE	ACTIVE	PDIP	N	24	15	Pb-Free (RoHS)	CU NIPDAU	N / A for Pkg Type	-55 to 125	CD4097BE	<a href="#">Samples</a>
CD4097BF	ACTIVE	CDIP	J	24	1	TBD	Call TI	N / A for Pkg Type	-55 to 125	CD4097BF	<a href="#">Samples</a>
CD4097BM	ACTIVE	SOIC	DW	24	25	Green (RoHS & no Sb/Br)	CU NIPDAU	Level-1-260C-UNLIM	-55 to 125	CD4097BM	<a href="#">Samples</a>
CD4097BME4	ACTIVE	SOIC	DW	24	25	Green (RoHS & no Sb/Br)	CU NIPDAU	Level-1-260C-UNLIM	-55 to 125	CD4097BM	<a href="#">Samples</a>
CD4097BMG4	ACTIVE	SOIC	DW	24	25	Green (RoHS & no Sb/Br)	CU NIPDAU	Level-1-260C-UNLIM	-55 to 125	CD4097BM	<a href="#">Samples</a>
CD4097BPW	ACTIVE	TSSOP	PW	24	60	Green (RoHS & no Sb/Br)	CU NIPDAU	Level-1-260C-UNLIM	-55 to 125	CM097B	<a href="#">Samples</a>

Orderable Device	Status (1)	Package Type	Package Drawing	Pins	Package Qty	Eco Plan (2)	Lead/Ball Finish (6)	MSL Peak Temp (3)	Op Temp (°C)	Device Marking (4/5)	Samples
CD4097BPWR	ACTIVE	TSSOP	PW	24	2000	Green (RoHS & no Sb/Br)	CU NIPDAU	Level-1-260C-UNLIM	-55 to 125	CM097B	
CD4097BPWRE4	ACTIVE	TSSOP	PW	24	2000	Green (RoHS & no Sb/Br)	CU NIPDAU	Level-1-260C-UNLIM	-55 to 125	CM097B	

(1) The marketing status values are defined as follows:

**ACTIVE:** Product device recommended for new designs.

**LIFEBUY:** TI has announced that the device will be discontinued, and a lifetime-buy period is in effect.

**NRND:** Not recommended for new designs. Device is in production to support existing customers, but TI does not recommend using this part in a new design.

**PREVIEW:** Device has been announced but is not in production. Samples may or may not be available.

**OBSOLETE:** TI has discontinued the production of the device.

(2) Eco Plan - The planned eco-friendly classification: Pb-Free (RoHS), Pb-Free (RoHS Exempt), or Green (RoHS & no Sb/Br) - please check <http://www.ti.com/productcontent> for the latest availability information and additional product content details.

**TBD:** The Pb-Free/Green conversion plan has not been defined.

**Pb-Free (RoHS):** TI's terms "Lead-Free" or "Pb-Free" mean semiconductor products that are compatible with the current RoHS requirements for all 6 substances, including the requirement that lead not exceed 0.1% by weight in homogeneous materials. Where designed to be soldered at high temperatures, TI Pb-Free products are suitable for use in specified lead-free processes.

**Pb-Free (RoHS Exempt):** This component has a RoHS exemption for either 1) lead-based flip-chip solder bumps used between the die and package, or 2) lead-based die adhesive used between the die and leadframe. The component is otherwise considered Pb-Free (RoHS compatible) as defined above.

**Green (RoHS & no Sb/Br):** TI defines "Green" to mean Pb-Free (RoHS compatible), and free of Bromine (Br) and Antimony (Sb) based flame retardants (Br or Sb do not exceed 0.1% by weight in homogeneous material)

(3) MSL, Peak Temp. - The Moisture Sensitivity Level rating according to the JEDEC industry standard classifications, and peak solder temperature.

(4) There may be additional marking, which relates to the logo, the lot trace code information, or the environmental category on the device.

(5) Multiple Device Markings will be inside parentheses. Only one Device Marking contained in parentheses and separated by a "~" will appear on a device. If a line is indented then it is a continuation of the previous line and the two combined represent the entire Device Marking for that device.

(6) Lead/Ball Finish - Orderable Devices may have multiple material finish options. Finish options are separated by a vertical ruled line. Lead/Ball Finish values may wrap to two lines if the finish value exceeds the maximum column width.

**Important Information and Disclaimer:** The information provided on this page represents TI's knowledge and belief as of the date that it is provided. TI bases its knowledge and belief on information provided by third parties, and makes no representation or warranty as to the accuracy of such information. Efforts are underway to better integrate information from third parties. TI has taken and continues to take reasonable steps to provide representative and accurate information but may not have conducted destructive testing or chemical analysis on incoming materials and chemicals. TI and TI suppliers consider certain information to be proprietary, and thus CAS numbers and other limited information may not be available for release.

In no event shall TI's liability arising out of such information exceed the total purchase price of the TI part(s) at issue in this document sold by TI to Customer on an annual basis.



**OTHER QUALIFIED VERSIONS OF CD4067B, CD4067B-MIL, CD4097B, CD4097B-MIL :**

- Catalog: [CD4067B](#), [CD4097B](#)
- Military: [CD4067B-MIL](#), [CD4097B-MIL](#)

## NOTE: Qualified Version Definitions:

- Catalog - TI's standard catalog product
- Military - QML certified for Military and Defense Applications

**TAPE AND REEL INFORMATION**

**QUADRANT ASSIGNMENTS FOR PIN 1 ORIENTATION IN TAPE**

\*All dimensions are nominal

Device	Package Type	Package Drawing	Pins	SPQ	Reel Diameter (mm)	Reel Width W1 (mm)	A0 (mm)	B0 (mm)	K0 (mm)	P1 (mm)	W (mm)	Pin1 Quadrant
CD4067BM96	SOIC	DW	24	2000	330.0	24.4	10.75	15.7	2.7	12.0	24.0	Q1
CD4067BM96G4	SOIC	DW	24	2000	330.0	24.4	10.75	15.7	2.7	12.0	24.0	Q1
CD4097BPWR	TSSOP	PW	24	2000	330.0	16.4	6.95	8.3	1.6	8.0	16.0	Q1

**TAPE AND REEL BOX DIMENSIONS**

\*All dimensions are nominal

Device	Package Type	Package Drawing	Pins	SPQ	Length (mm)	Width (mm)	Height (mm)
CD4067BM96	SOIC	DW	24	2000	367.0	367.0	45.0
CD4067BM96G4	SOIC	DW	24	2000	367.0	367.0	45.0
CD4097BPWR	TSSOP	PW	24	2000	367.0	367.0	38.0

J (R-GDIP-T\*\*)

CERAMIC DUAL-IN-LINE PACKAGE

24 PINS SHOWN



- NOTES: A. All linear dimensions are in inches (millimeters).  
 B. This drawing is subject to change without notice.  
 C. Window (lens) added to this group of packages (24-, 28-, 32-, 40-pin).  
 D. This package can be hermetically sealed with a ceramic lid using glass frit.  
 E. Index point is provided on cap for terminal identification.

**N (R-PDIP-T\*\*)**

**PLASTIC DUAL-IN-LINE PACKAGE**

24 PIN SHOWN



- NOTES: A. All linear dimensions are in inches (millimeters).  
 B. This drawing is subject to change without notice.  
 C. Falls within JEDEC MS-011  
 D. Falls within JEDEC MS-015 (32 pin only)

DW (R-PDSO-G24)

PLASTIC SMALL OUTLINE



- NOTES:
- A. All linear dimensions are in inches (millimeters). Dimensioning and tolerancing per ASME Y14.5M-1994.
  - B. This drawing is subject to change without notice.
  - C. Body dimensions do not include mold flash or protrusion not to exceed 0.006 (0,15).
  - D. Falls within JEDEC MS-013 variation AD.



PW (R-PDSO-G24)

PLASTIC SMALL OUTLINE



4040064-6/G 02/11

- NOTES:
- A. All linear dimensions are in millimeters. Dimensioning and tolerancing per ASME Y14.5M-1994.
  - B. This drawing is subject to change without notice.
  -  C. Body length does not include mold flash, protrusions, or gate burrs. Mold flash, protrusions, or gate burrs shall not exceed 0,15 each side.
  -  D. Body width does not include interlead flash. Interlead flash shall not exceed 0,25 each side.
  - E. Falls within JEDEC MO-153

PW (R-PDSO-G24)

PLASTIC SMALL OUTLINE

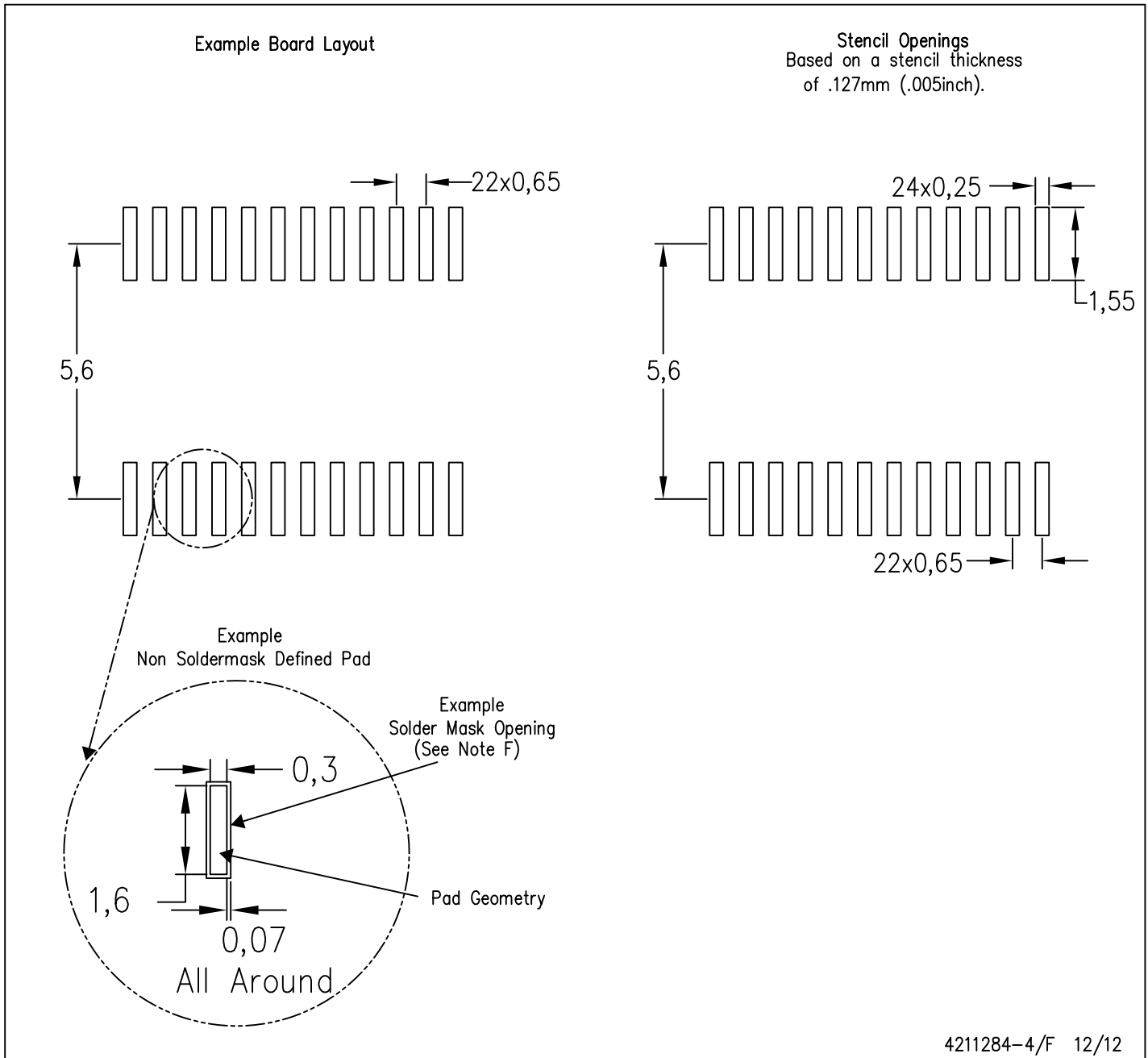

- NOTES:
- A. All linear dimensions are in millimeters.
  - B. This drawing is subject to change without notice.
  - C. Publication IPC-7351 is recommended for alternate design.
  - D. Laser cutting apertures with trapezoidal walls and also rounding corners will offer better paste release. Customers should contact their board assembly site for stencil design recommendations. Refer to IPC-7525 for other stencil recommendations.
  - E. Customers should contact their board fabrication site for solder mask tolerances between and around signal pads.

## IMPORTANT NOTICE

Texas Instruments Incorporated and its subsidiaries (TI) reserve the right to make corrections, enhancements, improvements and other changes to its semiconductor products and services per JESD46, latest issue, and to discontinue any product or service per JESD48, latest issue. Buyers should obtain the latest relevant information before placing orders and should verify that such information is current and complete. All semiconductor products (also referred to herein as "components") are sold subject to TI's terms and conditions of sale supplied at the time of order acknowledgment.

TI warrants performance of its components to the specifications applicable at the time of sale, in accordance with the warranty in TI's terms and conditions of sale of semiconductor products. Testing and other quality control techniques are used to the extent TI deems necessary to support this warranty. Except where mandated by applicable law, testing of all parameters of each component is not necessarily performed.

TI assumes no liability for applications assistance or the design of Buyers' products. Buyers are responsible for their products and applications using TI components. To minimize the risks associated with Buyers' products and applications, Buyers should provide adequate design and operating safeguards.

TI does not warrant or represent that any license, either express or implied, is granted under any patent right, copyright, mask work right, or other intellectual property right relating to any combination, machine, or process in which TI components or services are used. Information published by TI regarding third-party products or services does not constitute a license to use such products or services or a warranty or endorsement thereof. Use of such information may require a license from a third party under the patents or other intellectual property of the third party, or a license from TI under the patents or other intellectual property of TI.

Reproduction of significant portions of TI information in TI data books or data sheets is permissible only if reproduction is without alteration and is accompanied by all associated warranties, conditions, limitations, and notices. TI is not responsible or liable for such altered documentation. Information of third parties may be subject to additional restrictions.

Resale of TI components or services with statements different from or beyond the parameters stated by TI for that component or service voids all express and any implied warranties for the associated TI component or service and is an unfair and deceptive business practice. TI is not responsible or liable for any such statements.

Buyer acknowledges and agrees that it is solely responsible for compliance with all legal, regulatory and safety-related requirements concerning its products, and any use of TI components in its applications, notwithstanding any applications-related information or support that may be provided by TI. Buyer represents and agrees that it has all the necessary expertise to create and implement safeguards which anticipate dangerous consequences of failures, monitor failures and their consequences, lessen the likelihood of failures that might cause harm and take appropriate remedial actions. Buyer will fully indemnify TI and its representatives against any damages arising out of the use of any TI components in safety-critical applications.

In some cases, TI components may be promoted specifically to facilitate safety-related applications. With such components, TI's goal is to help enable customers to design and create their own end-product solutions that meet applicable functional safety standards and requirements. Nonetheless, such components are subject to these terms.

No TI components are authorized for use in FDA Class III (or similar life-critical medical equipment) unless authorized officers of the parties have executed a special agreement specifically governing such use.

Only those TI components which TI has specifically designated as military grade or "enhanced plastic" are designed and intended for use in military/aerospace applications or environments. Buyer acknowledges and agrees that any military or aerospace use of TI components which have **not** been so designated is solely at the Buyer's risk, and that Buyer is solely responsible for compliance with all legal and regulatory requirements in connection with such use.

TI has specifically designated certain components as meeting ISO/TS16949 requirements, mainly for automotive use. In any case of use of non-designated products, TI will not be responsible for any failure to meet ISO/TS16949.

### Products

Audio	<a href="http://www.ti.com/audio">www.ti.com/audio</a>
Amplifiers	<a href="http://amplifier.ti.com">amplifier.ti.com</a>
Data Converters	<a href="http://dataconverter.ti.com">dataconverter.ti.com</a>
DLP® Products	<a href="http://www.dlp.com">www.dlp.com</a>
DSP	<a href="http://dsp.ti.com">dsp.ti.com</a>
Clocks and Timers	<a href="http://www.ti.com/clocks">www.ti.com/clocks</a>
Interface	<a href="http://interface.ti.com">interface.ti.com</a>
Logic	<a href="http://logic.ti.com">logic.ti.com</a>
Power Mgmt	<a href="http://power.ti.com">power.ti.com</a>
Microcontrollers	<a href="http://microcontroller.ti.com">microcontroller.ti.com</a>
RFID	<a href="http://www.ti-rfid.com">www.ti-rfid.com</a>
OMAP Applications Processors	<a href="http://www.ti.com/omap">www.ti.com/omap</a>
Wireless Connectivity	<a href="http://www.ti.com/wirelessconnectivity">www.ti.com/wirelessconnectivity</a>

### Applications

Automotive and Transportation	<a href="http://www.ti.com/automotive">www.ti.com/automotive</a>
Communications and Telecom	<a href="http://www.ti.com/communications">www.ti.com/communications</a>
Computers and Peripherals	<a href="http://www.ti.com/computers">www.ti.com/computers</a>
Consumer Electronics	<a href="http://www.ti.com/consumer-apps">www.ti.com/consumer-apps</a>
Energy and Lighting	<a href="http://www.ti.com/energy">www.ti.com/energy</a>
Industrial	<a href="http://www.ti.com/industrial">www.ti.com/industrial</a>
Medical	<a href="http://www.ti.com/medical">www.ti.com/medical</a>
Security	<a href="http://www.ti.com/security">www.ti.com/security</a>
Space, Avionics and Defense	<a href="http://www.ti.com/space-avionics-defense">www.ti.com/space-avionics-defense</a>
Video and Imaging	<a href="http://www.ti.com/video">www.ti.com/video</a>

### TI E2E Community

[e2e.ti.com](http://e2e.ti.com)