

## 2.9 nV/sqrt(Hz) Low Noise, Precision, RRIO Amplifier

Check for Samples: [LMP7731](#)

### FEATURES

(Typical Values,  $T_A = 25^\circ\text{C}$ ,  $V_S = 5\text{V}$ )

- **Input Voltage Noise**
  - $f = 3\text{ Hz}$   $3.3\text{ nV}/\sqrt{\text{Hz}}$
  - $f = 1\text{ kHz}$   $2.9\text{ nV}/\sqrt{\text{Hz}}$
- **CMRR 130 dB**
- **Open Loop Gain 130 dB**
- **GBW 22 MHz**
- **Slew Rate 2.4 V/ $\mu\text{s}$**
- **THD @  $f = 10\text{ kHz}$ ,  $A_V = +1$ ,  $R_L = 2\text{ k}\Omega$  0.001%**
- **Supply Current per Channel 2.2 mA**
- **Supply Voltage Range 1.8V to 5.5V**
- **Operating Temperature Range  $-40^\circ\text{C}$  to  $125^\circ\text{C}$**
- **Input Bias Current  $\pm 1.5\text{ nA}$**
- **RRIO**

### APPLICATIONS

- **Gas Analysis Instruments**
- **Photometric Instrumentation**
- **Medical Instrumentation**

### DESCRIPTION

The LMP7731 is a single, low noise, rail-to-rail input and output, low voltage amplifier. The LMP7731 is part of the LMP™ precision amplifier family and is ideal for precision and low noise applications with low voltage requirements.

This operational amplifier offers low voltage noise of  $2.9\text{ nV}/\sqrt{\text{Hz}}$  with a  $1/f$  corner of only 3 Hz. The LMP7731 has bipolar input stages with a bias current of only 1.5 nA. This low input bias current, complemented by the very low level of voltage noise, makes the LMP7731 an excellent choice for photometry applications.

The LMP7731 provides a wide GBW of 22 MHz while consuming only 2 mA of current. This high gain bandwidth along with the high open loop gain of 130 dB enables accurate signal conditioning in applications with high closed loop gain requirements.

The LMP7731 has a supply voltage range of 1.8V to 5.5V, making it an ideal choice for battery operated portable applications.

The LMP7731 is offered in the space saving 5-Pin SOT-23 and 8-Pin SOIC packages.

### Typical Performance Characteristics

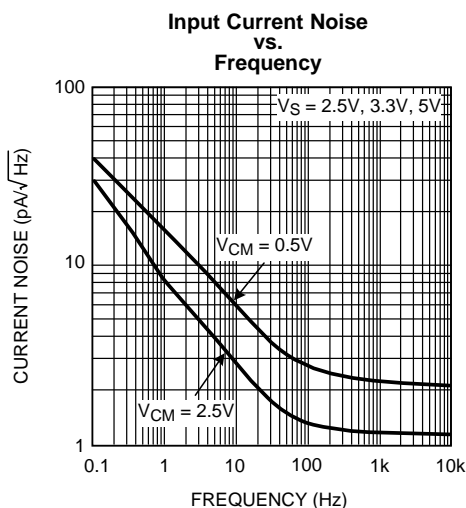
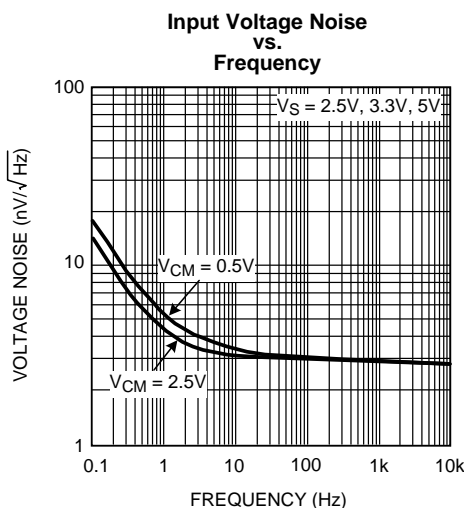

Please be aware that an important notice concerning availability, standard warranty, and use in critical applications of Texas Instruments semiconductor products and disclaimers thereto appears at the end of this data sheet.

LMP is a trademark of Texas Instruments.

All other trademarks are the property of their respective owners.



These devices have limited built-in ESD protection. The leads should be shorted together or the device placed in conductive foam during storage or handling to prevent electrostatic damage to the MOS gates.

### Absolute Maximum Ratings <sup>(1)(2)</sup>

|  |                                    |                  |                |
|--|------------------------------------|------------------|----------------|
| ESD Tolerance <sup>(3)</sup>                                       | Human Body Model                   | Inputs pins only | 2000V          |
|  |                                    | All other pins   | 2000V          |
|  | Machine Model                      |                  | 200V           |
|  | Charge Device Model                |                  | 1000V          |
| V <sub>IN</sub> Differential                                       |                                    |                  | ±2V            |
| Supply Voltage (V <sub>S</sub> = V <sup>+</sup> – V <sup>-</sup> ) |                                    |                  | 6.0V           |
| Storage Temperature Range  |                                    |                  | -65°C to 150°C |
| Junction Temperature <sup>(4)</sup>                                |                                    |                  | +150°C max     |
| Soldering Information  | Infrared or Convection (20 sec)    |                  | 235°C          |
|  | Wave Soldering Lead Temp. (10 sec) |                  | 260°C          |

- (1) Absolute Maximum Ratings indicate limits beyond which damage to the device may occur. Operating Ratings indicate conditions for which the device is intended to be functional, but specific performance is not ensured. For ensured specifications and the test conditions, see the Electrical Characteristics Tables.
- (2) If Military/Aerospace specified devices are required, please contact the TI Sales Office/ Distributors for availability and specifications.
- (3) Human Body Model, applicable std. MIL-STD-883, Method 3015.7. Machine Model, applicable std. JESD22-A115-A (ESD MM std. of JEDEC) Field-Induced Charge-Device Model, applicable std. JESD22-C101-C (ESD FICDM std. of JEDEC).
- (4) The maximum power dissipation is a function of T<sub>J(MAX)</sub>, θ<sub>JA</sub>. The maximum allowable power dissipation at any ambient temperature is P<sub>D</sub> = (T<sub>J(MAX)</sub> – T<sub>A</sub>) / θ<sub>JA</sub>. All numbers apply for packages soldered directly onto a PC Board.

### Operating Ratings <sup>(1)</sup>

|  |              |                |
|--|--------------|----------------|
| Temperature Range  |              | -40°C to 125°C |
| Supply Voltage (V <sub>S</sub> = V <sup>+</sup> – V <sup>-</sup> ) |              | 1.8V to 5.5V   |
| Package Thermal Resistance (θ <sub>JA</sub> )                      | 5-Pin SOT-23 | 265°C/W        |
|  | 8-Pin SOIC   | 190°C/W        |

- (1) Absolute Maximum Ratings indicate limits beyond which damage to the device may occur. Operating Ratings indicate conditions for which the device is intended to be functional, but specific performance is not ensured. For ensured specifications and the test conditions, see the Electrical Characteristics Tables.

### 2.5V Electrical Characteristics <sup>(1)</sup>

Unless otherwise specified, all limits are ensured for T<sub>A</sub> = 25°C, V<sup>+</sup> = 2.5V, V<sup>-</sup> = 0V, V<sub>CM</sub> = V<sup>+</sup>/2, R<sub>L</sub> > 10 kΩ to V<sup>+</sup>/2. **Boldface** limits apply at the temperature extremes.

| Parameter         |  | Test Conditions        | Min <sup>(2)</sup> | Typ <sup>(3)</sup> | Max <sup>(2)</sup>  | Units |
|-------------------|--|------------------------|--------------------|--------------------|---------------------|-------|
| V <sub>OS</sub>   | Input Offset Voltage <sup>(4)</sup>    | V <sub>CM</sub> = 2.0V |                    | ±9                 | ±500<br><b>±600</b> | µV    |
|                   |  | V <sub>CM</sub> = 0.5V |                    | ±9                 | ±500<br><b>±600</b> |       |
| TCV <sub>OS</sub> | Input Offset Voltage Temperature Drift | V <sub>CM</sub> = 2.0V |                    | ±0.5               | ±5.5                | µV/°C |
|                   |  | V <sub>CM</sub> = 0.5V |                    | ±0.2               | ±5.5                |       |
| I <sub>B</sub>    | Input Bias Current                     | V <sub>CM</sub> = 2.0V |                    | ±1                 | ±30<br><b>±45</b>   | nA    |
|                   |  | V <sub>CM</sub> = 0.5V |                    | ±12                | ±50<br><b>±75</b>   |       |

- (1) Electrical Table values apply only for factory testing conditions at the temperature indicated. Factory testing conditions result in very limited self-heating of the device such that T<sub>J</sub> = T<sub>A</sub>. No specification of parametric performance is indicated in the electrical tables under conditions of internal self-heating where T<sub>J</sub> > T<sub>A</sub>. Absolute maximum Ratings indicate junction temperature limits beyond which the device maybe permanently degraded, either mechanically or electrically.
- (2) All limits are specified by testing, statistical analysis or design.
- (3) Typical values represent the most likely parametric norm as determined at the time of characterization. Actual typical values may vary over time and will also depend on the application and configuration. The typical values are not tested and are not ensured on shipped production material.
- (4) Ambient production test is performed at 25°C with a variance of ±3°C.

## 2.5V Electrical Characteristics <sup>(1)</sup> (continued)

Unless otherwise specified, all limits are ensured for  $T_A = 25^\circ\text{C}$ ,  $V^+ = 2.5\text{V}$ ,  $V^- = 0\text{V}$ ,  $V_{\text{CM}} = V^+/2$ ,  $R_L > 10\text{ k}\Omega$  to  $V^+/2$ . **Boldface** limits apply at the temperature extremes.

| Parameter                |                                      | Test Conditions  | Min <sup>(2)</sup> | Typ <sup>(3)</sup> | Max <sup>(2)</sup>                     | Units                  |
|--------------------------|--------------------------------------|--|--------------------|--------------------|--|------------------------|
| $I_{\text{OS}}$          | Input Offset Current                 | $V_{\text{CM}} = 2.0\text{V}$  |                    | $\pm 1$            | $\pm 50$<br><b><math>\pm 75</math></b> | nA                     |
|                          |                                      | $V_{\text{CM}} = 0.5\text{V}$  |                    | $\pm 11$           | $\pm 60$<br><b><math>\pm 80</math></b> |                        |
| $\text{TCI}_{\text{OS}}$ | Input Offset Current Drift           | $V_{\text{CM}} = 0.5\text{V}$ and $V_{\text{CM}} = 2.0\text{V}$  |                    | 0.0474             |  | nA/ $^\circ\text{C}$   |
| CMRR                     | Common Mode Rejection Ratio          | $0.15\text{V} \leq V_{\text{CM}} \leq 0.7\text{V}$<br>$0.23\text{V} \leq V_{\text{CM}} \leq 0.7\text{V}$ | 101<br><b>89</b>   | 120                |  | dB                     |
|                          |                                      | $1.5\text{V} \leq V_{\text{CM}} \leq 2.35\text{V}$<br>$1.5\text{V} \leq V_{\text{CM}} \leq 2.27\text{V}$ | 105<br><b>99</b>   | 129                |  |                        |
| PSRR                     | Power Supply Rejection Ratio         | $2.5\text{V} \leq V^+ \leq 5\text{V}$  | 111<br><b>105</b>  | 129                |  | dB                     |
|                          |                                      | $1.8\text{V} \leq V^+ \leq 5.5\text{V}$  |                    | 117                |  |                        |
| CMVR                     | Common Mode Voltage Range            | Large Signal CMRR $\geq 80\text{ dB}$  | 0                  |                    | 2.5                                    | V                      |
| $A_{\text{VOL}}$         | Open Loop Voltage Gain               | $R_L = 10\text{ k}\Omega$ to $V^+/2$<br>$V_{\text{OUT}} = 0.5\text{V}$ to $2.0\text{V}$                  | 112<br><b>104</b>  | 130                |  | dB                     |
|                          |                                      | $R_L = 2\text{ k}\Omega$ to $V^+/2$<br>$V_{\text{OUT}} = 0.5\text{V}$ to $2.0\text{V}$                   | 109<br><b>90</b>   | 119                |  |                        |
| $V_{\text{OUT}}$         | Output Voltage Swing High            | $R_L = 10\text{ k}\Omega$ to $V^+/2$   |                    | 4                  | 50<br><b>75</b>                        | mV from either rail    |
|                          |                                      | $R_L = 2\text{ k}\Omega$ to $V^+/2$  |                    | 13                 | 50<br><b>75</b>                        |                        |
|                          | Output Voltage Swing Low             | $R_L = 10\text{ k}\Omega$ to $V^+/2$   |                    | 6                  | 50<br><b>75</b>                        |                        |
|                          |                                      | $R_L = 2\text{ k}\Omega$ to $V^+/2$  |                    | 9                  | 50<br><b>75</b>                        |                        |
| $I_{\text{OUT}}$         | Output Current                       | Sourcing, $V_{\text{OUT}} = V^+/2$<br>$V_{\text{IN}}(\text{diff}) = 100\text{ mV}$                       | 22<br><b>12</b>    | 31                 |  | mA                     |
|                          |                                      | Sinking, $V_{\text{OUT}} = V^+/2$<br>$V_{\text{IN}}(\text{diff}) = -100\text{ mV}$                       | 15<br><b>10</b>    | 44                 |  |                        |
| $I_{\text{S}}$           | Supply Current (Per Channel)         | $V_{\text{CM}} = 2.0\text{V}$  |                    | 2.0                | 2.7<br><b>3.4</b>                      | mA                     |
|                          |                                      | $V_{\text{CM}} = 0.5\text{V}$  |                    | 2.3                | 3.1<br><b>3.9</b>                      |                        |
| SR                       | Slew Rate                            | $A_V = +1$ , $C_L = 10\text{ pF}$ , $R_L = 10\text{ k}\Omega$ to $V^+/2$ ,<br>$V_O = 2 V_{\text{PP}}$    |                    | 2.4                |  | V/ $\mu\text{s}$       |
| GBW                      | Gain Bandwidth                       | $C_L = 20\text{ pF}$ , $R_L = 10\text{ k}\Omega$ to $V^+/2$  |                    | 21                 |  | MHz                    |
| $G_M$                    | Gain Margin                          | $C_L = 20\text{ pF}$ , $R_L = 10\text{ k}\Omega$ to $V^+/2$  |                    | 14                 |  | dB                     |
| $\Phi_M$                 | Phase Margin                         | $C_L = 20\text{ pF}$ , $R_L = 10\text{ k}\Omega$ to $V^+/2$  |                    | 60                 |  | deg                    |
| $R_{\text{IN}}$          | Input Resistance                     | Differential Mode  |                    | 38                 |  | k $\Omega$             |
|                          |                                      | Common Mode  |                    | 151                |  | M $\Omega$             |
| THD+N                    | Total Harmonic Distortion + Noise    | $A_V = 1$ , $f = 1\text{ kHz}$ , Amplitude = 1V  |                    | 0.002              |  | %                      |
| $e_n$                    | Input Referred Voltage Noise Density | $f = 1\text{ kHz}$ , $V_{\text{CM}} = 2.0\text{V}$   |                    | 3                  |  | nV/ $\sqrt{\text{Hz}}$ |
|                          |                                      | $f = 1\text{ kHz}$ , $V_{\text{CM}} = 0.5\text{V}$   |                    | 3                  |  |                        |
|                          | Input Voltage Noise                  | 0.1 Hz to 10 Hz  |                    | 75                 |  | nV $_{\text{PP}}$      |
| $i_n$                    | Input Referred Current Noise Density | $f = 1\text{ kHz}$ , $V_{\text{CM}} = 2.0\text{V}$   |                    | 1.1                |  | pA/ $\sqrt{\text{Hz}}$ |
|                          |                                      | $f = 1\text{ kHz}$ , $V_{\text{CM}} = 0.5\text{V}$   |                    | 2.3                |  |                        |

### 3.3V Electrical Characteristics <sup>(1)</sup>

Unless otherwise specified, all limits are ensured for  $T_A = 25^\circ\text{C}$ ,  $V^+ = 3.3\text{V}$ ,  $V^- = 0\text{V}$ ,  $V_{\text{CM}} = V^+/2$ ,  $R_L > 10\text{ k}\Omega$  to  $V^+/2$ . **Boldface** limits apply at the temperature extremes.

| Parameter                |  | Test Conditions  | Min <sup>(2)</sup> | Typ <sup>(3)</sup> | Max <sup>(2)</sup>                       | Units                        |
|--------------------------|--|--|--------------------|--------------------|--|------------------------------|
| $V_{\text{OS}}$          | Input Offset Voltage <sup>(4)</sup>  | $V_{\text{CM}} = 2.5\text{V}$  |                    | $\pm 6$            | $\pm 500$<br><b><math>\pm 600</math></b> | $\mu\text{V}$                |
|                          |  | $V_{\text{CM}} = 0.5\text{V}$  |                    | $\pm 6$            | $\pm 500$<br><b><math>\pm 600</math></b> |                              |
| $\text{TCV}_{\text{OS}}$ | Input Offset Voltage Temperature Drift   | $V_{\text{CM}} = 2.5\text{V}$  |                    | $\pm 0.5$          | $\pm 5.5$                                | $\mu\text{V}/^\circ\text{C}$ |
|                          |  | $V_{\text{CM}} = 0.5\text{V}$  |                    | $\pm 0.2$          | $\pm 5.5$                                |                              |
| $I_{\text{B}}$           | Input Bias Current   | $V_{\text{CM}} = 2.5\text{V}$  |                    | $\pm 1.5$          | $\pm 30$<br><b><math>\pm 45</math></b>   | nA                           |
|                          |  | $V_{\text{CM}} = 0.5\text{V}$  |                    | $\pm 13$           | $\pm 50$<br><b><math>\pm 77</math></b>   |                              |
| $I_{\text{OS}}$          | Input Offset Current   | $V_{\text{CM}} = 2.5\text{V}$  |                    | $\pm 1$            | $\pm 50$<br><b><math>\pm 70</math></b>   | nA                           |
|                          |  | $V_{\text{CM}} = 0.5\text{V}$  |                    | $\pm 11$           | $\pm 60$<br><b><math>\pm 80</math></b>   |                              |
| $\text{TCI}_{\text{OS}}$ | Input Offset Current Drift   | $V_{\text{CM}} = 0.5\text{V}$ and $V_{\text{CM}} = 2.5\text{V}$  |                    | 0.048              |  | $\text{nA}/^\circ\text{C}$   |
| CMRR                     | Common Mode Rejection Ratio  | $0.15\text{V} \leq V_{\text{CM}} \leq 0.7\text{V}$   | 101                | 120                |  | dB                           |
|                          |  | $0.23\text{V} \leq V_{\text{CM}} \leq 0.7\text{V}$   | <b>89</b>          |                    |  |                              |
| PSRR                     | Power Supply Rejection Ratio   | $1.5\text{V} \leq V_{\text{CM}} \leq 3.15\text{V}$   | 105                | 130                |  | dB                           |
|                          |  | $1.5\text{V} \leq V_{\text{CM}} \leq 3.07\text{V}$   | <b>99</b>          |                    |  |                              |
| CMVR                     | Common Mode Voltage Range  | $2.5\text{V} \leq V^+ \leq 5.0\text{V}$  | 111                | 129                |  | dB                           |
|                          |  | $1.8\text{V} \leq V^+ \leq 5.5\text{V}$  | <b>105</b>         | 117                |  |                              |
| $A_{\text{VOL}}$         | Open Loop Voltage Gain   | Large Signal CMRR $\geq 80\text{ dB}$  | 0                  |                    | 3.3                                      | V                            |
|                          |  | $R_L = 10\text{ k}\Omega$ to $V^+/2$<br>$V_{\text{OUT}} = 0.5\text{V}$ to $2.8\text{V}$                          | 112                | 130                |  | dB                           |
|                          | $R_L = 2\text{ k}\Omega$ to $V^+/2$<br>$V_{\text{OUT}} = 0.5\text{V}$ to $2.8\text{V}$ | 110  | 119                |                    |  |                              |
| $V_{\text{OUT}}$         | Output Voltage Swing High  | $R_L = 10\text{ k}\Omega$ to $V^+/2$   |                    | 5                  | 50<br><b>75</b>                          | mV from either rail          |
|                          |  | $R_L = 2\text{ k}\Omega$ to $V^+/2$  |                    | 14                 | 50<br><b>75</b>                          |                              |
|                          | Output Voltage Swing Low   | $R_L = 10\text{ k}\Omega$ to $V^+/2$   |                    | 9                  | 50<br><b>75</b>                          |                              |
|                          |  | $R_L = 2\text{ k}\Omega$ to $V^+/2$  |                    | 13                 | 50<br><b>75</b>                          |                              |
| $I_{\text{OUT}}$         | Output Current   | Sourcing, $V_{\text{OUT}} = V^+/2$<br>$V_{\text{IN}}(\text{diff}) = 100\text{ mV}$                               | 28                 | 45                 |  | mA                           |
|                          |  | Sinking, $V_{\text{OUT}} = V^+/2$<br>$V_{\text{IN}}(\text{diff}) = -100\text{ mV}$                               | 25                 | 48                 |  |                              |
| $I_{\text{S}}$           | Supply Current (Per Channel)   | $V_{\text{CM}} = 2.5\text{V}$  |                    | 2.1                | 2.8<br><b>3.5</b>                        | mA                           |
|                          |  | $V_{\text{CM}} = 0.5\text{V}$  |                    | 2.4                | 3.2<br><b>4.0</b>                        |                              |
| SR                       | Slew Rate  | $A_V = +1$ , $C_L = 10\text{ pF}$ , $R_L = 10\text{ k}\Omega$ to $V^+/2$ ,<br>$V_{\text{OUT}} = 2 V_{\text{PP}}$ |                    | 2.4                |  | $\text{V}/\mu\text{s}$       |

- (1) Electrical Table values apply only for factory testing conditions at the temperature indicated. Factory testing conditions result in very limited self-heating of the device such that  $T_J = T_A$ . No specification of parametric performance is indicated in the electrical tables under conditions of internal self-heating where  $T_J > T_A$ . Absolute maximum Ratings indicate junction temperature limits beyond which the device maybe permanently degraded, either mechanically or electrically.
- (2) All limits are specified by testing, statistical analysis or design.
- (3) Typical values represent the most likely parametric norm as determined at the time of characterization. Actual typical values may vary over time and will also depend on the application and configuration. The typical values are not tested and are not ensured on shipped production material.
- (4) Ambient production test is performed at  $25^\circ\text{C}$  with a variance of  $\pm 3^\circ\text{C}$ .

### 3.3V Electrical Characteristics <sup>(1)</sup> (continued)

Unless otherwise specified, all limits are ensured for  $T_A = 25^\circ\text{C}$ ,  $V^+ = 3.3\text{V}$ ,  $V^- = 0\text{V}$ ,  $V_{\text{CM}} = V^+/2$ ,  $R_L > 10\text{ k}\Omega$  to  $V^+/2$ . **Boldface** limits apply at the temperature extremes.

| Parameter       |                                      | Test Conditions   | Min <sup>(2)</sup> | Typ <sup>(3)</sup> | Max <sup>(2)</sup> | Units                  |
|-----------------|--------------------------------------|---|--------------------|--------------------|--------------------|------------------------|
| GBW             | Gain Bandwidth                       | $C_L = 20\text{ pF}$ , $R_L = 10\text{ k}\Omega$ to $V^+/2$ |                    | 22                 |                    | MHz                    |
| $G_M$           | Gain Margin                          | $C_L = 20\text{ pF}$ , $R_L = 10\text{ k}\Omega$ to $V^+/2$ |                    | 14                 |                    | dB                     |
| $\Phi_M$        | Phase Margin                         | $C_L = 20\text{ pF}$ , $R_L = 10\text{ k}\Omega$ to $V^+/2$ |                    | 62                 |                    | deg                    |
| $R_{\text{IN}}$ | Input Resistance                     | Differential Mode   |                    | 38                 |                    | k $\Omega$             |
|                 |                                      | Common Mode   |                    | 151                |                    | M $\Omega$             |
| THD+N           | Total Harmonic Distortion + Noise    | $A_V = 1$ , $f = 1\text{ kHz}$ , Amplitude = 1V,            |                    | 0.002              |                    | %                      |
| $e_n$           | Input Referred Voltage Noise Density | $f = 1\text{ kHz}$ , $V_{\text{CM}} = 2.5\text{V}$          |                    | 2.9                |                    | nV/ $\sqrt{\text{Hz}}$ |
|                 |                                      | $f = 1\text{ kHz}$ , $V_{\text{CM}} = 0.5\text{V}$          |                    | 2.9                |                    |                        |
|                 | Input Voltage Noise                  | 0.1 Hz to 10 Hz   |                    | 65                 |                    | nV <sub>PP</sub>       |
| $i_n$           | Input Referred Current Noise Density | $f = 1\text{ kHz}$ , $V_{\text{CM}} = 2.5\text{V}$          |                    | 1.1                |                    | pA/ $\sqrt{\text{Hz}}$ |
|                 |                                      | $f = 1\text{ kHz}$ , $V_{\text{CM}} = 0.5\text{V}$          |                    | 2.1                |                    |                        |

### 5V Electrical Characteristics <sup>(1)</sup>

Unless otherwise specified, all limits are ensured for  $T_A = 25^\circ\text{C}$ ,  $V^+ = 5\text{V}$ ,  $V^- = 0\text{V}$ ,  $V_{\text{CM}} = V^+/2$ ,  $R_L > 10\text{ k}\Omega$  to  $V^+/2$ . **Boldface** limits apply at the temperature extremes.

| Parameter         |  | Test Conditions  | Min <sup>(2)</sup> | Typ <sup>(3)</sup> | Max <sup>(2)</sup>                       | Units                        |
|-------------------|--|--|--------------------|--------------------|--|------------------------------|
| $V_{\text{OS}}$   | Input Offset Voltage <sup>(4)</sup>    | $V_{\text{CM}} = 4.5\text{V}$  |                    | $\pm 6$            | $\pm 500$<br><b><math>\pm 600</math></b> | $\mu\text{V}$                |
|                   |  | $V_{\text{CM}} = 0.5\text{V}$  |                    | $\pm 6$            | $\pm 500$<br><b><math>\pm 600</math></b> |                              |
| TCV <sub>OS</sub> | Input Offset Voltage Temperature Drift | $V_{\text{CM}} = 4.5\text{V}$  |                    | $\pm 0.5$          | $\pm 5.5$                                | $\mu\text{V}/^\circ\text{C}$ |
|                   |  | $V_{\text{CM}} = 0.5\text{V}$  |                    | $\pm 0.2$          | $\pm 5.5$                                |                              |
| $I_B$             | Input Bias Current                     | $V_{\text{CM}} = 4.5\text{V}$  |                    | $\pm 1.5$          | $\pm 30$<br><b><math>\pm 50</math></b>   | nA                           |
|                   |  | $V_{\text{CM}} = 0.5\text{V}$  |                    | $\pm 14$           | $\pm 50$<br><b><math>\pm 85</math></b>   |                              |
| $I_{\text{OS}}$   | Input Offset Current                   | $V_{\text{CM}} = 4.5\text{V}$  |                    | $\pm 1$            | $\pm 50$<br><b><math>\pm 70</math></b>   | nA                           |
|                   |  | $V_{\text{CM}} = 0.5\text{V}$  |                    | $\pm 11$           | $\pm 65$<br><b><math>\pm 80</math></b>   |                              |
| TCI <sub>OS</sub> | Input Offset Current Drift             | $V_{\text{CM}} = 0.5\text{V}$ and $V_{\text{CM}} = 4.5\text{V}$  |                    | 0.0482             |  | nA/ $^\circ\text{C}$         |
| CMRR              | Common Mode Rejection Ratio            | $0.15\text{V} \leq V_{\text{CM}} \leq 0.7\text{V}$   | 101                | 120                |  | dB                           |
|                   |  | $0.23\text{V} \leq V_{\text{CM}} \leq 0.7\text{V}$   | <b>89</b>          |                    |  |                              |
|                   |  | $1.5\text{V} \leq V_{\text{CM}} \leq 4.85\text{V}$<br>$1.5\text{V} \leq V_{\text{CM}} \leq 4.77\text{V}$ | 105<br><b>99</b>   | 130                |  |                              |
| PSRR              | Power Supply Rejection Ratio           | $2.5\text{V} \leq V^+ \leq 5\text{V}$  | 111<br><b>105</b>  | 129                |  | dB                           |
|                   |  | $1.8\text{V} \leq V^+ \leq 5.5\text{V}$  |                    | 117                |  |                              |
| CMVR              | Common Mode Voltage Range              | Large Signal CMRR $\geq 80\text{ dB}$  | 0                  |                    | 5  | V                            |
| $A_{\text{VOL}}$  | Open Loop Voltage Gain                 | $R_L = 10\text{ k}\Omega$ to $V^+/2$<br>$V_{\text{OUT}} = 0.5\text{V}$ to $4.5\text{V}$                  | 112<br><b>104</b>  | 130                |  | dB                           |
|                   |  | $R_L = 2\text{ k}\Omega$ to $V^+/2$<br>$V_{\text{OUT}} = 0.5\text{V}$ to $4.5\text{V}$                   | 110<br><b>94</b>   | 119                |  |                              |

(1) Electrical Table values apply only for factory testing conditions at the temperature indicated. Factory testing conditions result in very limited self-heating of the device such that  $T_J = T_A$ . No specification of parametric performance is indicated in the electrical tables under conditions of internal self-heating where  $T_J > T_A$ . Absolute maximum Ratings indicate junction temperature limits beyond which the device maybe permanently degraded, either mechanically or electrically.

(2) All limits are specified by testing, statistical analysis or design.

(3) Typical values represent the most likely parametric norm as determined at the time of characterization. Actual typical values may vary over time and will also depend on the application and configuration. The typical values are not tested and are not ensured on shipped production material.

(4) Ambient production test is performed at  $25^\circ\text{C}$  with a variance of  $\pm 3^\circ\text{C}$ .

### 5V Electrical Characteristics <sup>(1)</sup> (continued)

Unless otherwise specified, all limits are ensured for  $T_A = 25^\circ\text{C}$ ,  $V^+ = 5\text{V}$ ,  $V^- = 0\text{V}$ ,  $V_{CM} = V^+/2$ ,  $R_L > 10\text{ k}\Omega$  to  $V^+/2$ . **Boldface** limits apply at the temperature extremes.

| Parameter |                                      | Test Conditions   | Min <sup>(2)</sup> | Typ <sup>(3)</sup> | Max <sup>(2)</sup> | Units                  |
|-----------|--------------------------------------|---|--------------------|--------------------|--------------------|------------------------|
| $V_{OUT}$ | Output Voltage Swing High            | $R_L = 10\text{ k}\Omega$ to $V^+/2$  |                    | 8                  | 50<br><b>75</b>    | mV from either rail    |
|           |                                      | $R_L = 2\text{ k}\Omega$ to $V^+/2$   |                    | 24                 | 50<br><b>75</b>    |                        |
|           | Output Voltage Swing Low             | $R_L = 10\text{ k}\Omega$ to $V^+/2$  |                    | 9                  | 50<br><b>75</b>    |                        |
|           |                                      | $R_L = 2\text{ k}\Omega$ to $V^+/2$   |                    | 23                 | 50<br><b>75</b>    |                        |
| $I_{OUT}$ | Output Current                       | Sourcing, $V_{OUT} = V^+/2$<br>$V_{IN}(\text{diff}) = 100\text{ mV}$                                      | 33<br><b>27</b>    | 47                 |                    | mA                     |
|           |                                      | Sinking, $V_{OUT} = V^+/2$<br>$V_{IN}(\text{diff}) = -100\text{ mV}$                                      | 30<br><b>25</b>    | 49                 |                    |                        |
| $I_S$     | Supply Current (Per Channel)         | $V_{CM} = 4.5\text{V}$  |                    | 2.2                | 3.0<br><b>3.7</b>  | mA                     |
|           |                                      | $V_{CM} = 0.5\text{V}$  |                    | 2.5                | 3.4<br><b>4.2</b>  |                        |
| SR        | Slew Rate                            | $A_V = +1$ , $C_L = 10\text{ pF}$ , $R_L = 10\text{ k}\Omega$ to $V^+/2$ ,<br>$V_{OUT} = 2\text{ V}_{PP}$ |                    | 2.4                |                    | V/ $\mu\text{s}$       |
| GBW       | Gain Bandwidth                       | $C_L = 20\text{ pF}$ , $R_L = 10\text{ k}\Omega$ to $V^+/2$   |                    | 22                 |                    | MHz                    |
| $G_M$     | Gain Margin                          | $C_L = 20\text{ pF}$ , $R_L = 10\text{ k}\Omega$ to $V^+/2$   |                    | 12                 |                    | dB                     |
| $\Phi_M$  | Phase Margin                         | $C_L = 20\text{ pF}$ , $R_L = 10\text{ k}\Omega$ to $V^+/2$   |                    | 65                 |                    | deg                    |
| $R_{IN}$  | Input Resistance                     | Differential Mode   |                    | 38                 |                    | k $\Omega$             |
|           |                                      | Common Mode   |                    | 151                |                    | M $\Omega$             |
| THD+N     | Total Harmonic Distortion + Noise    | $A_V = 1$ , $f = 1\text{ kHz}$ , Amplitude = 1V   |                    | 0.001              |                    | %                      |
| $e_n$     | Input Referred Voltage Noise Density | $f = 1\text{ kHz}$ , $V_{CM} = 4.5\text{V}$   |                    | 2.9                |                    | nV/ $\sqrt{\text{Hz}}$ |
|           |                                      | $f = 1\text{ kHz}$ , $V_{CM} = 0.5\text{V}$   |                    | 2.9                |                    |                        |
|           | Input Voltage Noise                  | 0.1 Hz to 10 Hz   |                    | 78                 |                    | nV $_{PP}$             |
| $i_n$     | Input Referred Current Noise Density | $f = 1\text{ kHz}$ , $V_{CM} = 4.5\text{V}$   |                    | 1.1                |                    | pA/ $\sqrt{\text{Hz}}$ |
|           |                                      | $f = 1\text{ kHz}$ , $V_{CM} = 0.5\text{V}$   |                    | 2.2                |                    |                        |

### Connection Diagrams

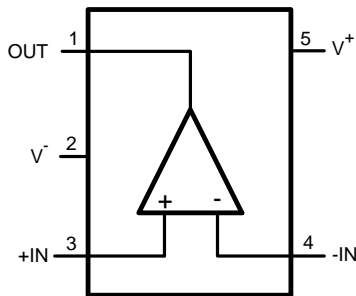

Figure 3. 5-Pin SOT-23 Top View

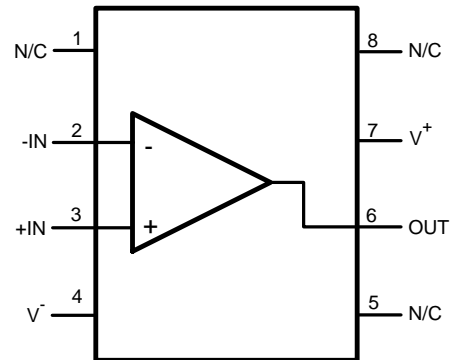

Figure 4. 8-Pin SOIC Top View

### Typical Performance Characteristics

Unless otherwise noted:  $T_A = 25^\circ\text{C}$ ,  $R_L > 10\text{ k}\Omega$ ,  $V_{CM} = V_S/2$ .

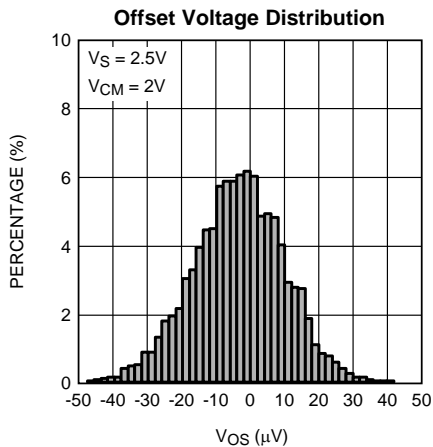

Figure 5.

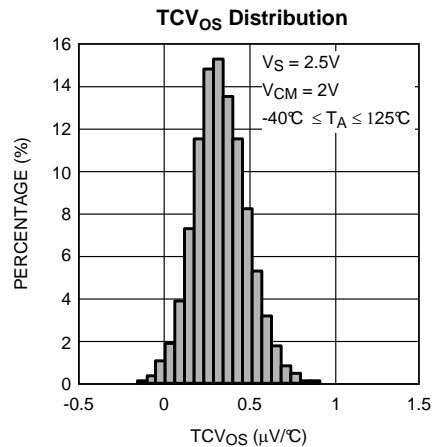

Figure 6.

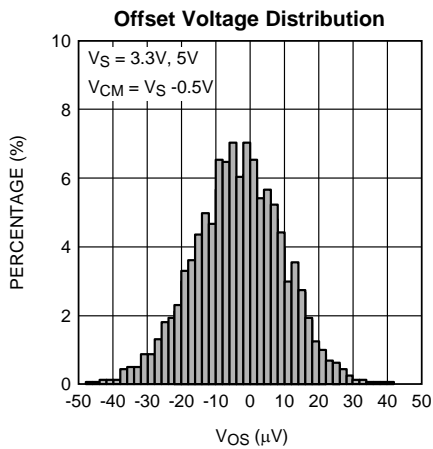

Figure 7.

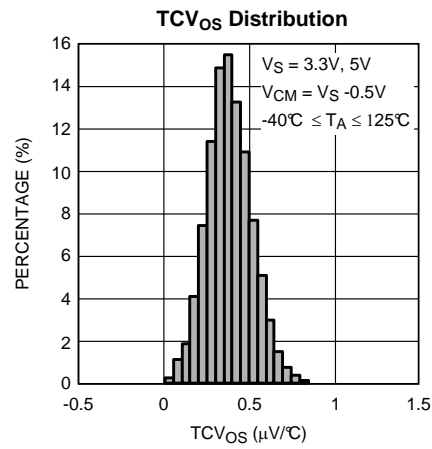

Figure 8.

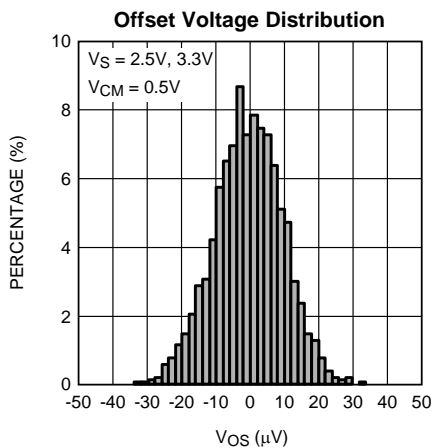

Figure 9.

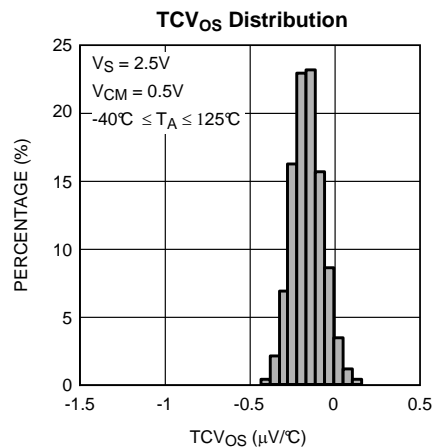

Figure 10.

### Typical Performance Characteristics (continued)

Unless otherwise noted:  $T_A = 25^\circ\text{C}$ ,  $R_L > 10\text{ k}\Omega$ ,  $V_{CM} = V_S/2$ .

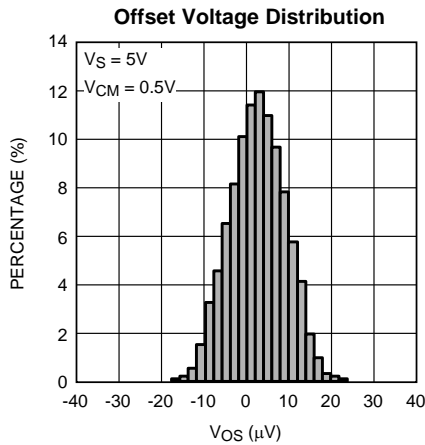

Figure 11.

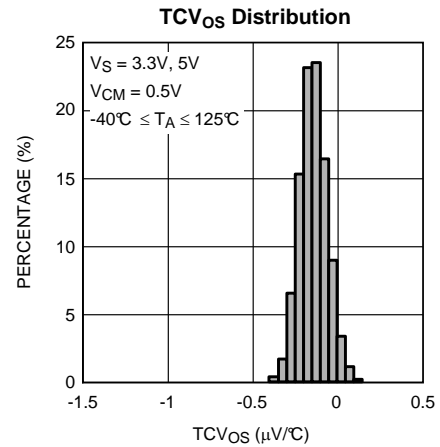

Figure 12.

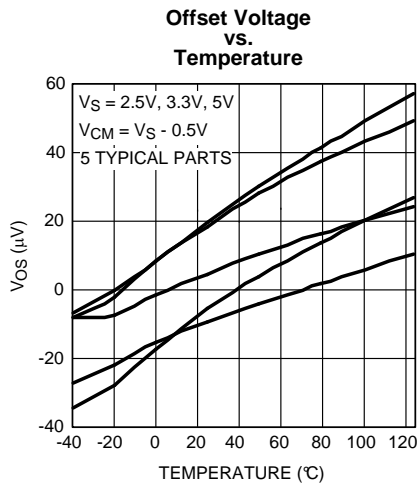

Figure 13.

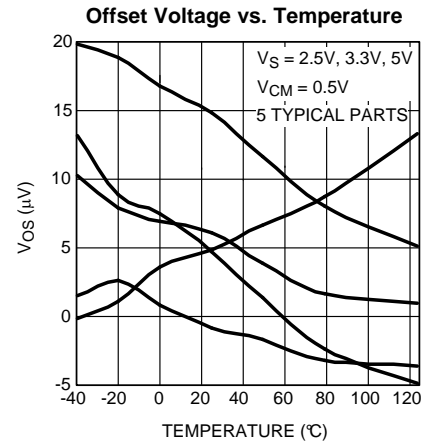

Figure 14.

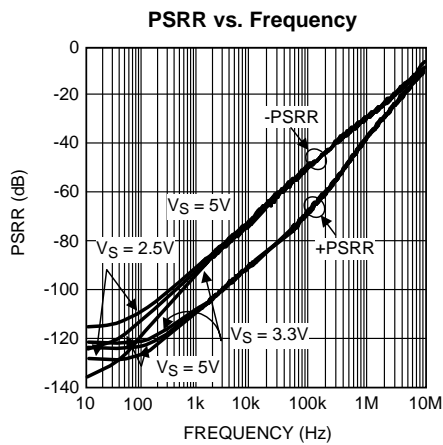

Figure 15.

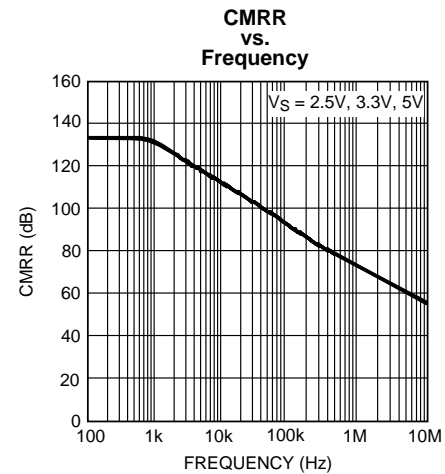

Figure 16.



Typical Performance Characteristics (continued)

Unless otherwise noted:  $T_A = 25^\circ\text{C}$ ,  $R_L > 10\text{ k}\Omega$ ,  $V_{CM} = V_S/2$ .

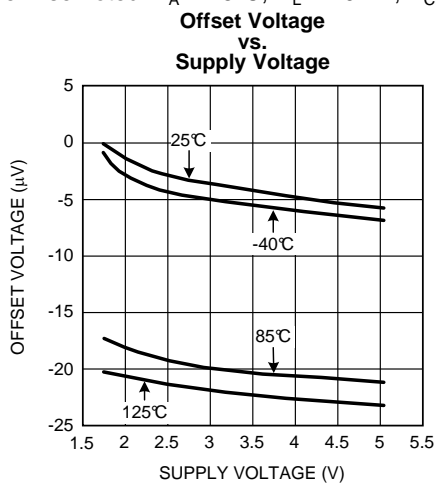

Figure 17.

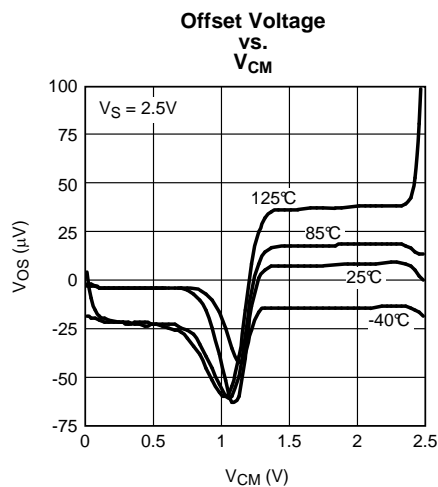

Figure 18.

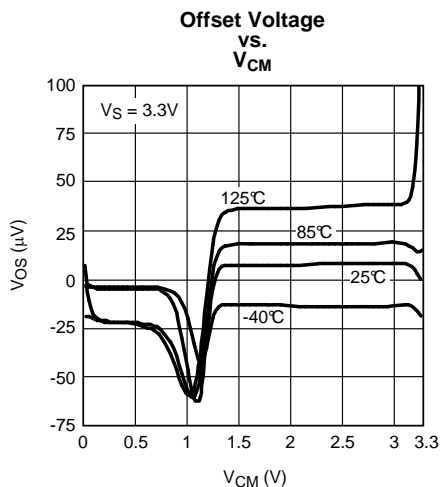

Figure 19.

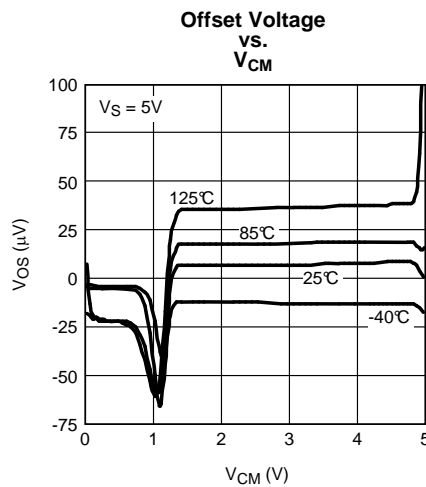

Figure 20.

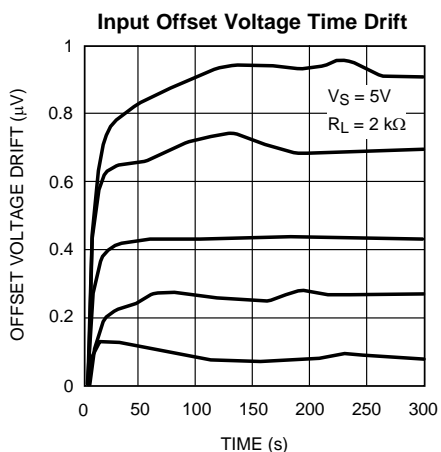

Figure 21.

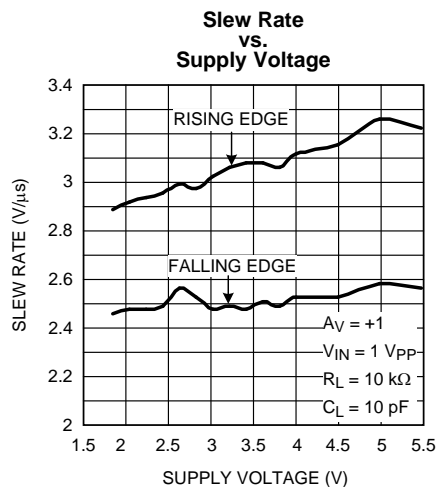
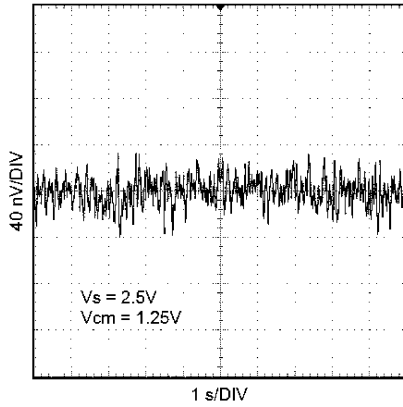

Figure 22.

**Typical Performance Characteristics (continued)**

Unless otherwise noted:  $T_A = 25^\circ\text{C}$ ,  $R_L > 10\text{ k}\Omega$ ,  $V_{CM} = V_S/2$ .

**Time Domain Voltage Noise**



**Figure 23.**

**Time Domain Voltage Noise**

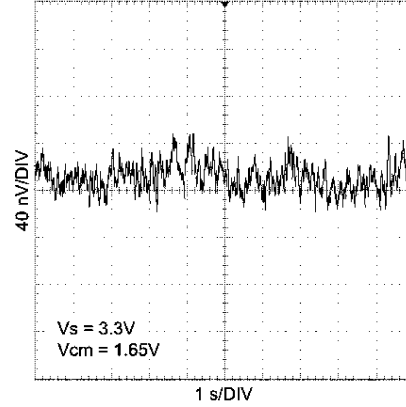

**Figure 24.**

**Time Domain Voltage Noise**

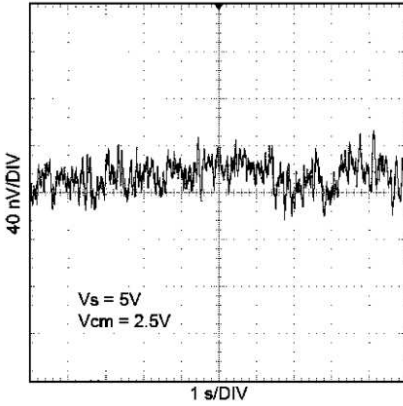

**Figure 25.**

**Output Voltage vs. Output Current**

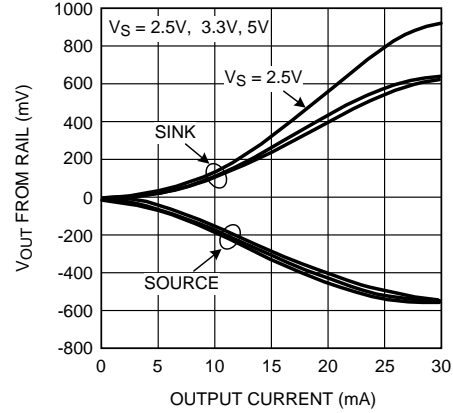

**Figure 26.**

**Input Bias Current vs. V<sub>CM</sub>**

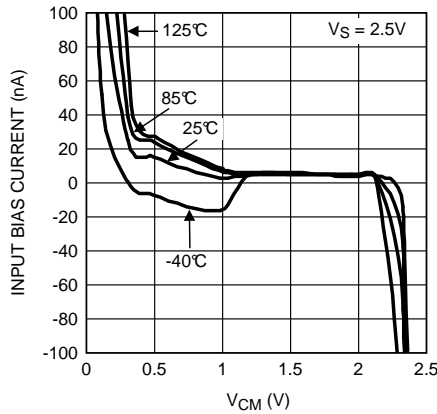

**Figure 27.**

**Input Bias Current vs. V<sub>CM</sub>**

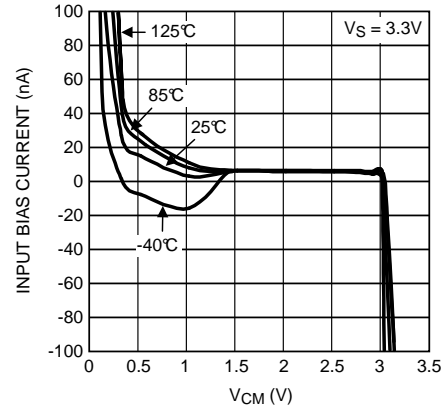

**Figure 28.**

Typical Performance Characteristics (continued)

Unless otherwise noted:  $T_A = 25^\circ\text{C}$ ,  $R_L > 10\text{ k}\Omega$ ,  $V_{CM} = V_S/2$ .

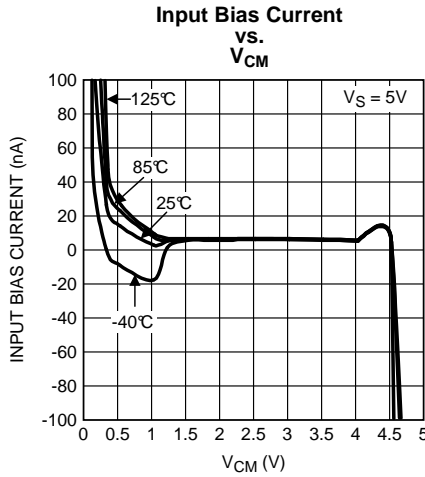

Figure 29.

Open Loop Frequency Response Over Temperature

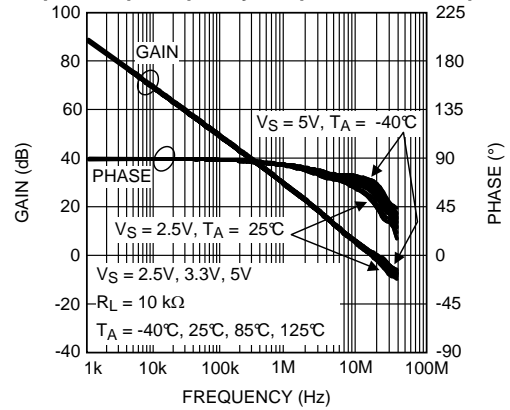

Figure 30.

Open Loop Frequency Response

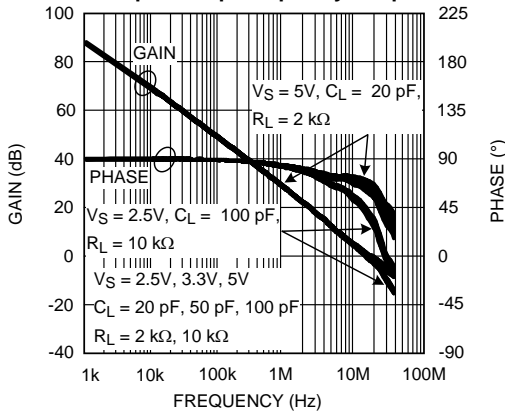

Figure 31.

Open Loop Frequency Response

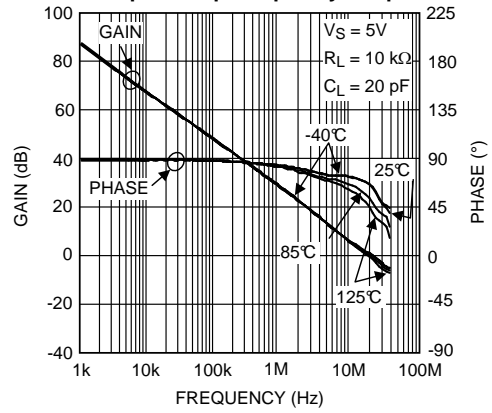

Figure 32.

THD+N vs. Frequency

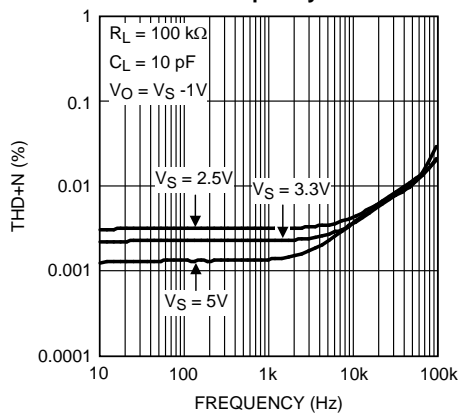

Figure 33.

THD+N vs. Output Voltage

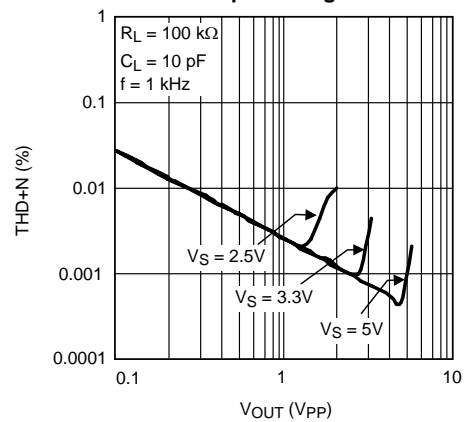
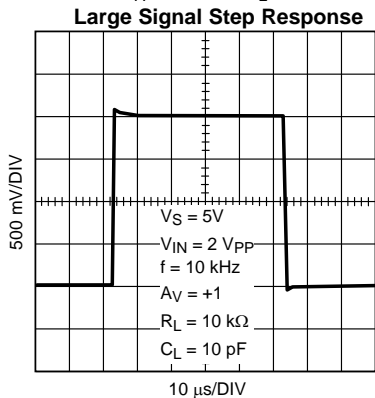

Figure 34.

**Typical Performance Characteristics (continued)**

Unless otherwise noted:  $T_A = 25^\circ\text{C}$ ,  $R_L > 10\text{ k}\Omega$ ,  $V_{CM} = V_S/2$ .



**Figure 35.**

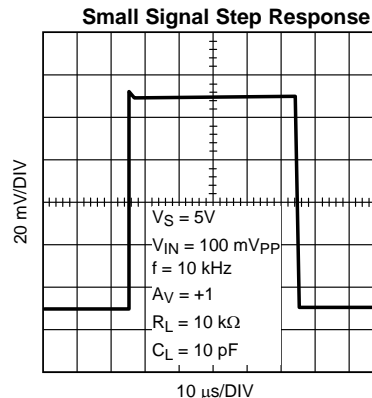

**Figure 36.**

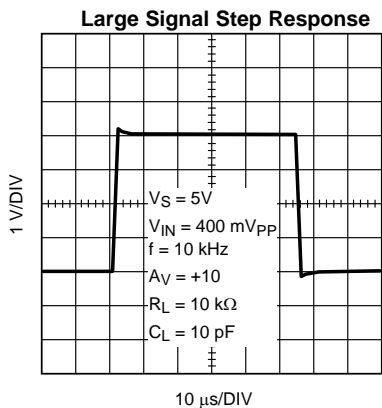

**Figure 37.**

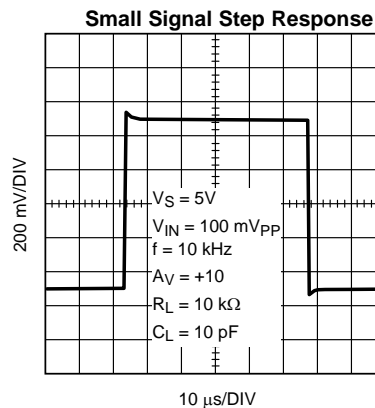

**Figure 38.**

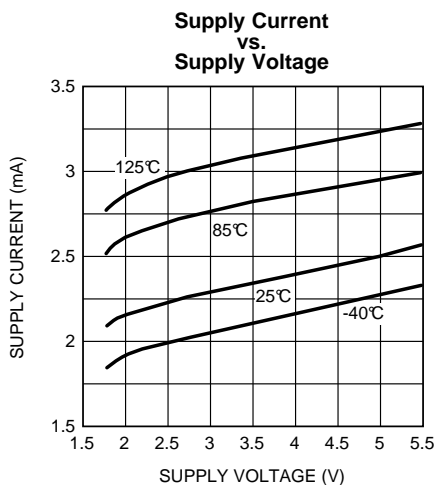

**Figure 39.**

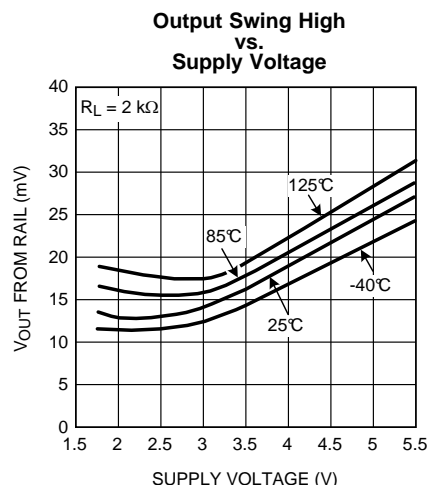
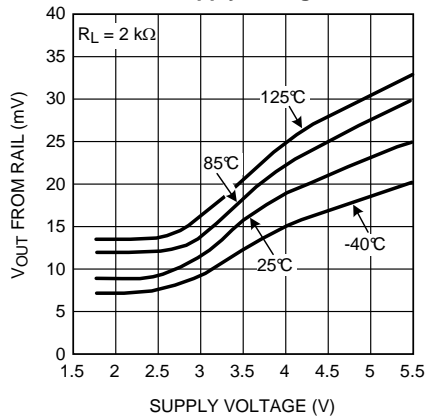

**Figure 40.**

**Typical Performance Characteristics (continued)**

Unless otherwise noted:  $T_A = 25^\circ\text{C}$ ,  $R_L > 10\text{ k}\Omega$ ,  $V_{CM} = V_S/2$ .

**Output Swing Low vs. Supply Voltage**



**Figure 41.**

**Sinking Current vs. Supply Voltage**

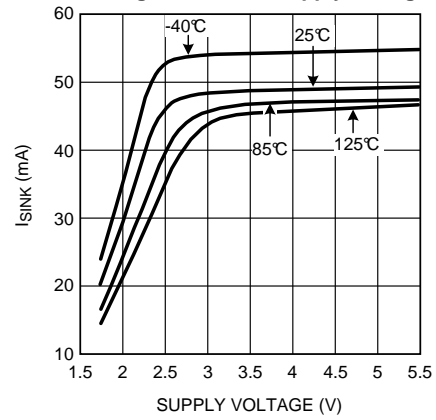

**Figure 42.**

**Sourcing Current vs. Supply Voltage**

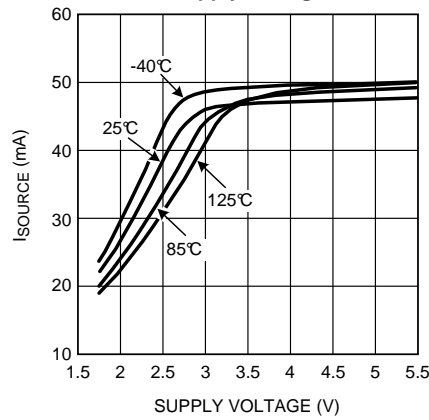

**Figure 43.**

## APPLICATION INFORMATION

### LMP7731

The LMP7731 is a single, low noise, rail-to-rail input and output, and low voltage amplifier.

The low input voltage noise of only  $2.9 \text{ nV}/\sqrt{\text{Hz}}$  with a  $1/f$  corner at 3 Hz makes the LMP7731 ideal for sensor applications where DC accuracy is of importance.

The LMP7731 has a high gain bandwidth of 22 MHz. This wide bandwidth enables use of the amplifier at higher gain settings while retaining usable bandwidth for the application. This is particularly beneficial when system designers need to use sensors with very limited output voltage range as it allows larger gains in one stage which in turn increases the signal to noise ratio.

The LMP7731 has proprietary input bias cancellation circuitry on the input stages. This allows the LMP7731 to have only about 1.5 nA bias current with a bipolar input stage. This low input bias current, paired with the inherent lower input voltage noise of bipolar input stages makes the LMP7731 an excellent choice for precision applications. The combination of low input bias current, and low input voltage noise enables the user to achieve unprecedented accuracy and higher signal integrity.

Texas Instruments is heavily committed to precision amplifiers and the market segment they serve. Technical support and extensive characterization data are available for sensitive applications or applications with a constrained error budget.

The LMP7731 is offered in the space saving 5-Pin SOT-23 and 8-Pin SOIC packages. These small packages are ideal solutions for area constrained PC boards and portable electronics.

### INPUT BIAS CURRENT CANCELLATION

The LMP7731 has proprietary input bias current cancellation circuitry on their input stages.

The LMP7731 has rail-to-rail input. This is achieved by having two input stages in parallel. [Figure 44](#) shows only one of the input stages as the circuitry is symmetrical for both stages.

[Figure 44](#) shows that as the common mode voltage gets closer to one of the extreme ends, current  $I_1$  significantly increases. This increased current shows as an increase in voltage drop across resistor  $R_1$  equal to  $I_1 \cdot R_1$  on  $\text{IN}^+$  of the amplifier. This voltage contributes to the offset voltage of the amplifier. When common mode voltage is in the mid-range, the transistors are operating in the linear region and  $I_1$  is significantly small. The voltage drop due to  $I_1$  across  $R_1$  can be ignored as it is orders of magnitude smaller than the amplifier's input offset voltage.

As the common mode voltage gets closer to one of the rails, the offset voltage generated due to  $I_1$  increases and becomes comparable to the amplifiers offset voltage.

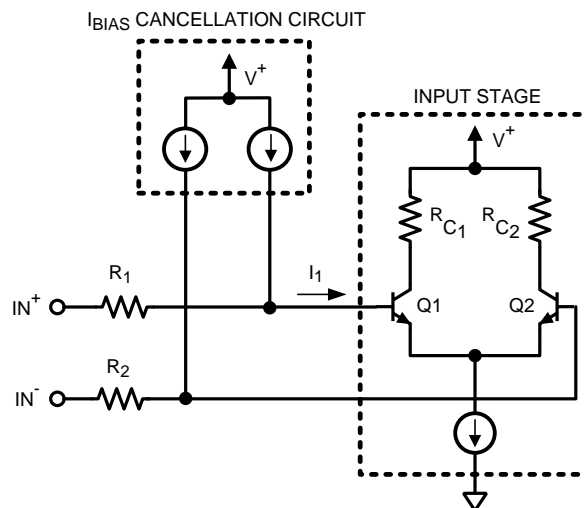

**Figure 44. Input Bias Current Cancellation**

## INPUT VOLTAGE NOISE MEASUREMENT

The LMP7731 has very low input voltage noise. The peak-to-peak input voltage noise of the LMP7731 can be measured using the test circuit shown in [Figure 45](#)

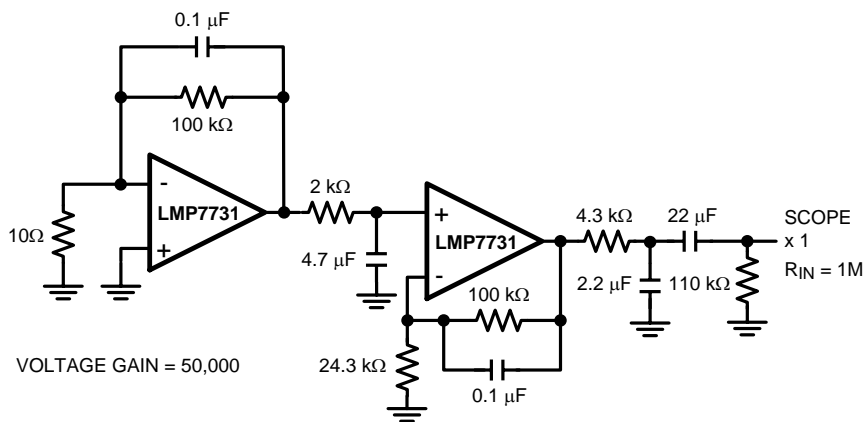

**Figure 45. 0.1 Hz to 10 Hz Noise Test Circuit**

The frequency response of this noise test circuit at the 0.1 Hz corner is defined by only one zero. The test time for the 0.1 Hz to 10 Hz noise measurement using this configuration should not exceed 10 seconds, as this time limit acts as an additional zero to reduce or eliminate the noise contributions of noise from frequencies below 0.1 Hz.

[Figure 46](#) shows typical peak-to-peak noise for the LMP7731 measured with the circuit in [Figure 45](#) for the LMP7731.

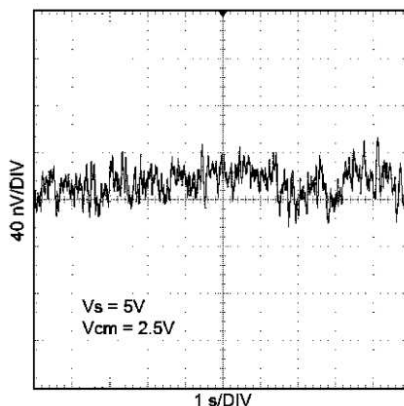

**Figure 46. 0.1 Hz to 10 Hz Input Voltage Noise**

Measuring the very low peak-to-peak noise performance of the LMP7731, requires special testing attention. In order to achieve accurate results, the device should be warmed up for at least five minutes. This is so that the input offset voltage of the op amp settles to a value. During this warm up period, the offset can typically change by a few  $\mu\text{V}$  because the chip temperature increases by about  $30^\circ\text{C}$ . If the 10 seconds of the measurement is selected to include this warm up time, some of this temperature change might show up as the measured noise. [Figure 47](#) shows the start-up drift of five typical LMP7731 units.

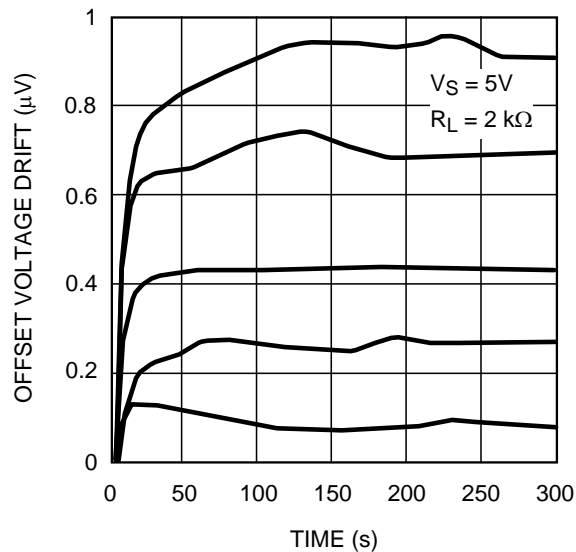
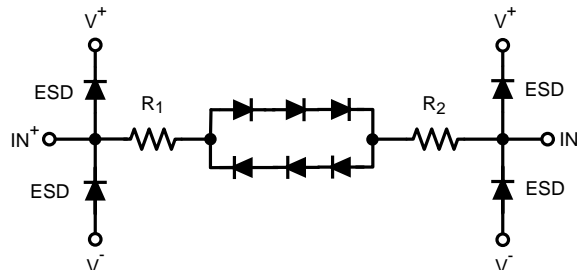

**Figure 47. Start-Up Input Offset Voltage Drift**

During the peak-to-peak noise measurement, the LMP7731 must be shielded. This prevents offset variations due to airflow. Offset can vary by a few nV due to this airflow and that can invalidate measurements of input voltage noise with a magnitude which is in the same range. For similar reasons, sudden motions must also be restricted in the vicinity of the test area. The feed-through which results from this motion could increase the observed noise value which in turn would invalidate the measurement.

## DIODES BETWEEN THE INPUTS

The LMP7731 has a set of anti-parallel diodes between the input pins as shown in [Figure 48](#). These diodes are present to protect the input stage of the amplifier. At the same time, they limit the amount of differential input voltage that is allowed on the input pins. A differential signal larger than the voltage needed to turn on the diodes might cause damage to the diodes. The differential voltage between the input pins should be limited to  $\pm 3$  diode drops or the input current needs to be limited to  $\pm 20$  mA.



**Figure 48. Anti-Parallel Diodes between Inputs**

## DRIVING AN ADC

Analog to Digital Converters, ADCs, usually have a sampling capacitor on their input. When the ADC's input is directly connected to the output of the amplifier a charging current flows from the amplifier to the ADC. This charging current causes a momentary glitch that can take some time to settle. There are different ways to minimize this effect. One way is to slow down the sampling rate. This method gives the amplifier sufficient time to stabilize its output. Another way to minimize the glitch caused by the switch capacitor is to have an external capacitor connected to the input of the ADC. This capacitor is chosen so that its value is much larger than the internal switching capacitor and it will hence provide the voltage needed to quickly and smoothly charge the



ADC's sampling capacitor. Since this large capacitor will be loading the output of the amplifier as well, an isolation resistor is needed between the output of the amplifier and this capacitor. The isolation resistor,  $R_{ISO}$ , separates the additional load capacitance from the output of the amplifier and will also form a low-pass filter and can be designed to provide noise reduction as well as anti-aliasing. The drawback to having  $R_{ISO}$  is that it reduces signal swing since there is some voltage drop across it.

Figure 49 (a) shows the ADC directly connected to the amplifier. To minimize the glitch in this setting, a slower sample rate needs to be used. Figure 49 (b) shows  $R_{ISO}$  and an external capacitor used to minimize the glitch.

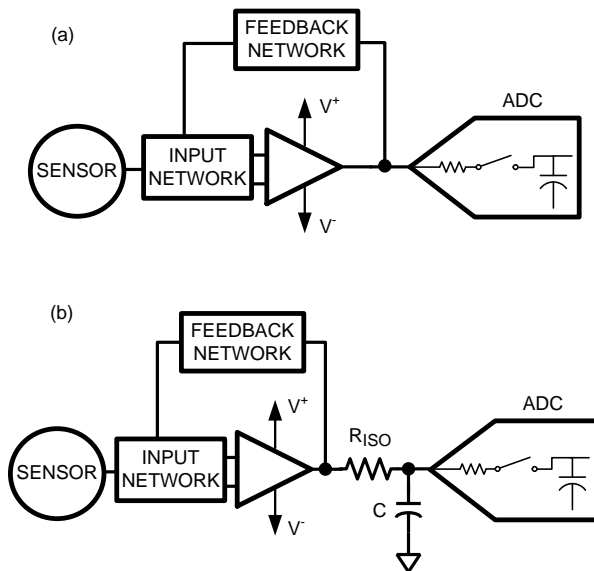

Figure 49. Driving an ADC

### REVISION HISTORY

| Changes from Revision D (March 2013) to Revision E         | Page               |
|--|--------------------|
| • Changed layout of National Data Sheet to TI format ..... | <a href="#">17</a> |

**PACKAGING INFORMATION**

| Orderable Device | Status<br>(1) | Package Type | Package Drawing | Pins | Package Qty | Eco Plan<br>(2)         | Lead/Ball Finish | MSL Peak Temp<br>(3) | Op Temp (°C) | Top-Side Markings<br>(4) | Samples                 |
|------------------|---------------|--------------|-----------------|------|-------------|-------------------------|------------------|----------------------|--------------|--------------------------|-------------------------|
| LMP7731MA/NOPB   | ACTIVE        | SOIC         | D               | 8    | 95          | Green (RoHS & no Sb/Br) | CU SN            | Level-1-260C-UNLIM   |              | LMP77<br>31MA            | <a href="#">Samples</a> |
| LMP7731MAX/NOPB  | ACTIVE        | SOIC         | D               | 8    | 2500        | Green (RoHS & no Sb/Br) | CU SN            | Level-1-260C-UNLIM   |              | LMP77<br>31MA            | <a href="#">Samples</a> |
| LMP7731MF/NOPB   | ACTIVE        | SOT-23       | DBV             | 5    | 1000        | Green (RoHS & no Sb/Br) | CU SN            | Level-1-260C-UNLIM   | -40 to 125   | AY3A                     | <a href="#">Samples</a> |
| LMP7731MFE/NOPB  | ACTIVE        | SOT-23       | DBV             | 5    | 250         | Green (RoHS & no Sb/Br) | CU SN            | Level-1-260C-UNLIM   | -40 to 125   | AY3A                     | <a href="#">Samples</a> |
| LMP7731MFX/NOPB  | ACTIVE        | SOT-23       | DBV             | 5    | 3000        | Green (RoHS & no Sb/Br) | CU SN            | Level-1-260C-UNLIM   | -40 to 125   | AY3A                     | <a href="#">Samples</a> |

(1) The marketing status values are defined as follows:

**ACTIVE:** Product device recommended for new designs.

**LIFEBUY:** TI has announced that the device will be discontinued, and a lifetime-buy period is in effect.

**NRND:** Not recommended for new designs. Device is in production to support existing customers, but TI does not recommend using this part in a new design.

**PREVIEW:** Device has been announced but is not in production. Samples may or may not be available.

**OBSOLETE:** TI has discontinued the production of the device.

(2) Eco Plan - The planned eco-friendly classification: Pb-Free (RoHS), Pb-Free (RoHS Exempt), or Green (RoHS & no Sb/Br) - please check <http://www.ti.com/productcontent> for the latest availability information and additional product content details.

**TBD:** The Pb-Free/Green conversion plan has not been defined.

**Pb-Free (RoHS):** TI's terms "Lead-Free" or "Pb-Free" mean semiconductor products that are compatible with the current RoHS requirements for all 6 substances, including the requirement that lead not exceed 0.1% by weight in homogeneous materials. Where designed to be soldered at high temperatures, TI Pb-Free products are suitable for use in specified lead-free processes.

**Pb-Free (RoHS Exempt):** This component has a RoHS exemption for either 1) lead-based flip-chip solder bumps used between the die and package, or 2) lead-based die adhesive used between the die and leadframe. The component is otherwise considered Pb-Free (RoHS compatible) as defined above.

**Green (RoHS & no Sb/Br):** TI defines "Green" to mean Pb-Free (RoHS compatible), and free of Bromine (Br) and Antimony (Sb) based flame retardants (Br or Sb do not exceed 0.1% by weight in homogeneous material)

(3) MSL, Peak Temp. -- The Moisture Sensitivity Level rating according to the JEDEC industry standard classifications, and peak solder temperature.

(4) Multiple Top-Side Markings will be inside parentheses. Only one Top-Side Marking contained in parentheses and separated by a "~" will appear on a device. If a line is indented then it is a continuation of the previous line and the two combined represent the entire Top-Side Marking for that device.

**Important Information and Disclaimer:** The information provided on this page represents TI's knowledge and belief as of the date that it is provided. TI bases its knowledge and belief on information provided by third parties, and makes no representation or warranty as to the accuracy of such information. Efforts are underway to better integrate information from third parties. TI has taken and continues to take reasonable steps to provide representative and accurate information but may not have conducted destructive testing or chemical analysis on incoming materials and chemicals. TI and TI suppliers consider certain information to be proprietary, and thus CAS numbers and other limited information may not be available for release.

In no event shall TI's liability arising out of such information exceed the total purchase price of the TI part(s) at issue in this document sold by TI to Customer on an annual basis.

**TAPE AND REEL INFORMATION**

**QUADRANT ASSIGNMENTS FOR PIN 1 ORIENTATION IN TAPE**

\*All dimensions are nominal

| Device          | Package Type | Package Drawing | Pins | SPQ  | Reel Diameter (mm) | Reel Width W1 (mm) | A0 (mm) | B0 (mm) | K0 (mm) | P1 (mm) | W (mm) | Pin1 Quadrant |
|-----------------|--------------|-----------------|------|------|--------------------|--------------------|---------|---------|---------|---------|--------|---------------|
| LMP7731MAX/NOPB | SOIC         | D               | 8    | 2500 | 330.0              | 12.4               | 6.5     | 5.4     | 2.0     | 8.0     | 12.0   | Q1            |
| LMP7731MF/NOPB  | SOT-23       | DBV             | 5    | 1000 | 178.0              | 8.4                | 3.2     | 3.2     | 1.4     | 4.0     | 8.0    | Q3            |
| LMP7731MFE/NOPB | SOT-23       | DBV             | 5    | 250  | 178.0              | 8.4                | 3.2     | 3.2     | 1.4     | 4.0     | 8.0    | Q3            |
| LMP7731MFX/NOPB | SOT-23       | DBV             | 5    | 3000 | 178.0              | 8.4                | 3.2     | 3.2     | 1.4     | 4.0     | 8.0    | Q3            |

**TAPE AND REEL BOX DIMENSIONS**

\*All dimensions are nominal

| Device          | Package Type | Package Drawing | Pins | SPQ  | Length (mm) | Width (mm) | Height (mm) |
|-----------------|--------------|-----------------|------|------|-------------|------------|-------------|
| LMP7731MAX/NOPB | SOIC         | D               | 8    | 2500 | 367.0       | 367.0      | 35.0        |
| LMP7731MF/NOPB  | SOT-23       | DBV             | 5    | 1000 | 210.0       | 185.0      | 35.0        |
| LMP7731MFE/NOPB | SOT-23       | DBV             | 5    | 250  | 210.0       | 185.0      | 35.0        |
| LMP7731MFX/NOPB | SOT-23       | DBV             | 5    | 3000 | 210.0       | 185.0      | 35.0        |

## GENERIC PACKAGE VIEW

DBV 5

SOT-23 - 1.45 mm max height

SMALL OUTLINE TRANSISTOR



Images above are just a representation of the package family, actual package may vary.  
Refer to the product data sheet for package details.

4073253/P

DBV0005A



# PACKAGE OUTLINE

SOT-23 - 1.45 mm max height

SMALL OUTLINE TRANSISTOR



4214839/C 04/2017

NOTES:

1. All linear dimensions are in millimeters. Any dimensions in parenthesis are for reference only. Dimensioning and tolerancing per ASME Y14.5M.
2. This drawing is subject to change without notice.
3. Reference JEDEC MO-178.



# EXAMPLE BOARD LAYOUT

DBV0005A

SOT-23 - 1.45 mm max height

SMALL OUTLINE TRANSISTOR



LAND PATTERN EXAMPLE  
EXPOSED METAL SHOWN  
SCALE:15X

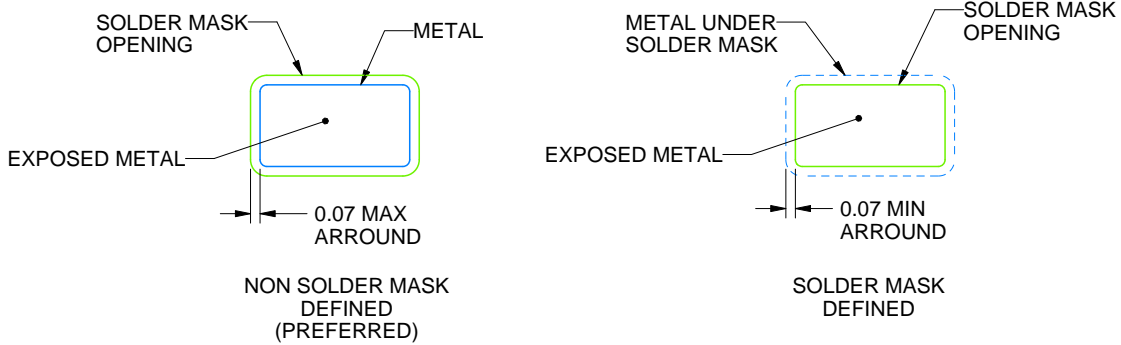

SOLDER MASK DETAILS

4214839/C 04/2017

NOTES: (continued)

4. Publication IPC-7351 may have alternate designs.
5. Solder mask tolerances between and around signal pads can vary based on board fabrication site.

# EXAMPLE STENCIL DESIGN

DBV0005A

SOT-23 - 1.45 mm max height

SMALL OUTLINE TRANSISTOR



SOLDER PASTE EXAMPLE  
BASED ON 0.125 mm THICK STENCIL  
SCALE:15X

4214839/C 04/2017

NOTES: (continued)

6. Laser cutting apertures with trapezoidal walls and rounded corners may offer better paste release. IPC-7525 may have alternate design recommendations.
7. Board assembly site may have different recommendations for stencil design.

D (R-PDSO-G8)

PLASTIC SMALL OUTLINE



- NOTES:
- A. All linear dimensions are in inches (millimeters).
  - B. This drawing is subject to change without notice.
  - C. Body length does not include mold flash, protrusions, or gate burrs. Mold flash, protrusions, or gate burrs shall not exceed 0.006 (0,15) each side.
  - D. Body width does not include interlead flash. Interlead flash shall not exceed 0.017 (0,43) each side.
  - E. Reference JEDEC MS-012 variation AA.

## IMPORTANT NOTICE

Texas Instruments Incorporated (TI) reserves the right to make corrections, enhancements, improvements and other changes to its semiconductor products and services per JESD46, latest issue, and to discontinue any product or service per JESD48, latest issue. Buyers should obtain the latest relevant information before placing orders and should verify that such information is current and complete.

TI's published terms of sale for semiconductor products (<http://www.ti.com/sc/docs/stdterms.htm>) apply to the sale of packaged integrated circuit products that TI has qualified and released to market. Additional terms may apply to the use or sale of other types of TI products and services.

Reproduction of significant portions of TI information in TI data sheets is permissible only if reproduction is without alteration and is accompanied by all associated warranties, conditions, limitations, and notices. TI is not responsible or liable for such reproduced documentation. Information of third parties may be subject to additional restrictions. Resale of TI products or services with statements different from or beyond the parameters stated by TI for that product or service voids all express and any implied warranties for the associated TI product or service and is an unfair and deceptive business practice. TI is not responsible or liable for any such statements.

Buyers and others who are developing systems that incorporate TI products (collectively, "Designers") understand and agree that Designers remain responsible for using their independent analysis, evaluation and judgment in designing their applications and that Designers have full and exclusive responsibility to assure the safety of Designers' applications and compliance of their applications (and of all TI products used in or for Designers' applications) with all applicable regulations, laws and other applicable requirements. Designer represents that, with respect to their applications, Designer has all the necessary expertise to create and implement safeguards that (1) anticipate dangerous consequences of failures, (2) monitor failures and their consequences, and (3) lessen the likelihood of failures that might cause harm and take appropriate actions. Designer agrees that prior to using or distributing any applications that include TI products, Designer will thoroughly test such applications and the functionality of such TI products as used in such applications.

TI's provision of technical, application or other design advice, quality characterization, reliability data or other services or information, including, but not limited to, reference designs and materials relating to evaluation modules, (collectively, "TI Resources") are intended to assist designers who are developing applications that incorporate TI products; by downloading, accessing or using TI Resources in any way, Designer (individually or, if Designer is acting on behalf of a company, Designer's company) agrees to use any particular TI Resource solely for this purpose and subject to the terms of this Notice.

TI's provision of TI Resources does not expand or otherwise alter TI's applicable published warranties or warranty disclaimers for TI products, and no additional obligations or liabilities arise from TI providing such TI Resources. TI reserves the right to make corrections, enhancements, improvements and other changes to its TI Resources. TI has not conducted any testing other than that specifically described in the published documentation for a particular TI Resource.

Designer is authorized to use, copy and modify any individual TI Resource only in connection with the development of applications that include the TI product(s) identified in such TI Resource. NO OTHER LICENSE, EXPRESS OR IMPLIED, BY ESTOPPEL OR OTHERWISE TO ANY OTHER TI INTELLECTUAL PROPERTY RIGHT, AND NO LICENSE TO ANY TECHNOLOGY OR INTELLECTUAL PROPERTY RIGHT OF TI OR ANY THIRD PARTY IS GRANTED HEREIN, including but not limited to any patent right, copyright, mask work right, or other intellectual property right relating to any combination, machine, or process in which TI products or services are used. Information regarding or referencing third-party products or services does not constitute a license to use such products or services, or a warranty or endorsement thereof. Use of TI Resources may require a license from a third party under the patents or other intellectual property of the third party, or a license from TI under the patents or other intellectual property of TI.

TI RESOURCES ARE PROVIDED "AS IS" AND WITH ALL FAULTS. TI DISCLAIMS ALL OTHER WARRANTIES OR REPRESENTATIONS, EXPRESS OR IMPLIED, REGARDING RESOURCES OR USE THEREOF, INCLUDING BUT NOT LIMITED TO ACCURACY OR COMPLETENESS, TITLE, ANY EPIDEMIC FAILURE WARRANTY AND ANY IMPLIED WARRANTIES OF MERCHANTABILITY, FITNESS FOR A PARTICULAR PURPOSE, AND NON-INFRINGEMENT OF ANY THIRD PARTY INTELLECTUAL PROPERTY RIGHTS. TI SHALL NOT BE LIABLE FOR AND SHALL NOT DEFEND OR INDEMNIFY DESIGNER AGAINST ANY CLAIM, INCLUDING BUT NOT LIMITED TO ANY INFRINGEMENT CLAIM THAT RELATES TO OR IS BASED ON ANY COMBINATION OF PRODUCTS EVEN IF DESCRIBED IN TI RESOURCES OR OTHERWISE. IN NO EVENT SHALL TI BE LIABLE FOR ANY ACTUAL, DIRECT, SPECIAL, COLLATERAL, INDIRECT, PUNITIVE, INCIDENTAL, CONSEQUENTIAL OR EXEMPLARY DAMAGES IN CONNECTION WITH OR ARISING OUT OF TI RESOURCES OR USE THEREOF, AND REGARDLESS OF WHETHER TI HAS BEEN ADVISED OF THE POSSIBILITY OF SUCH DAMAGES.

Unless TI has explicitly designated an individual product as meeting the requirements of a particular industry standard (e.g., ISO/TS 16949 and ISO 26262), TI is not responsible for any failure to meet such industry standard requirements.

Where TI specifically promotes products as facilitating functional safety or as compliant with industry functional safety standards, such products are intended to help enable customers to design and create their own applications that meet applicable functional safety standards and requirements. Using products in an application does not by itself establish any safety features in the application. Designers must ensure compliance with safety-related requirements and standards applicable to their applications. Designer may not use any TI products in life-critical medical equipment unless authorized officers of the parties have executed a special contract specifically governing such use. Life-critical medical equipment is medical equipment where failure of such equipment would cause serious bodily injury or death (e.g., life support, pacemakers, defibrillators, heart pumps, neurostimulators, and implantables). Such equipment includes, without limitation, all medical devices identified by the U.S. Food and Drug Administration as Class III devices and equivalent classifications outside the U.S.

TI may expressly designate certain products as completing a particular qualification (e.g., Q100, Military Grade, or Enhanced Product). Designers agree that it has the necessary expertise to select the product with the appropriate qualification designation for their applications and that proper product selection is at Designers' own risk. Designers are solely responsible for compliance with all legal and regulatory requirements in connection with such selection.

Designer will fully indemnify TI and its representatives against any damages, costs, losses, and/or liabilities arising out of Designer's non-compliance with the terms and provisions of this Notice.