

Processor Supervisory Circuits

Check for Samples: [TPS382x-xx](#), [TPS382xA-xx](#)

FEATURES

- Power-On Reset Generator With Fixed Delay
Time of 200 ms (TPS3823/4/5/8) or 25 ms (TPS3820)
- Manual Reset Input (TPS3820/3/5/8)
- Reset Output Available in Active-Low (TPS3820/3/4/5), Active-High (TPS3824/5) and Open-Drain (TPS3828)
- Supply Voltage Supervision Range:
2.5 V, 3 V, 3.3 V, 5 V
- Watchdog Timer (TPS3820/3/4/8)
- Supply Current of 15 μ A (Typ)
- SOT23-5 Package
- Temperature Range: -40°C to 85°C

APPLICATIONS

- Applications Using DSPs, Microcontrollers, or Microprocessors
- Industrial Equipment
- Programmable Controls
- Automotive Systems
- Portable/Battery-Powered Equipment
- Intelligent Instruments
- Wireless Communications Systems
- Notebook/Desktop Computers

DESCRIPTION

The TPS382x family of supervisors provide circuit initialization and timing supervision, primarily for DSP and processor-based systems. During power-on, $\overline{\text{RESET}}$ asserts when the supply voltage V_{DD} becomes higher than 1.1 V. Thereafter, the supply voltage supervisor monitors V_{DD} and keeps $\overline{\text{RESET}}$ active as long as V_{DD} remains below the threshold voltage, $V_{\text{IT-}}$. An internal timer delays the return of the output to the inactive state (high) to ensure proper system reset. The delay time, t_{d} , starts after V_{DD} has risen above the threshold voltage, $V_{\text{IT-}}$. When the supply voltage drops below the threshold voltage $V_{\text{IT-}}$, the output becomes active (low) again. No external components are required. All the devices of this family have a fixed-sense threshold voltage, $V_{\text{IT-}}$, set by an internal voltage divider.

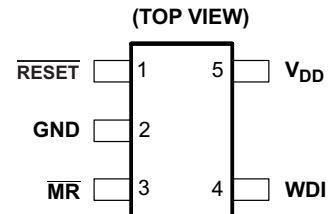
TPS3820, TPS3823, TPS3828: DBV PACKAGE
TPS3820A, TPS3823A, TPS3828A: DBV PACKAGE

TPS3824 and TPS3824A: DBV PACKAGE

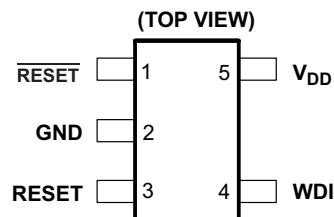
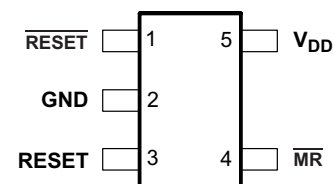
TPS3825 and TPS3825A: DBV PACKAGE
(TOP VIEW)

TYPICAL APPLICATION

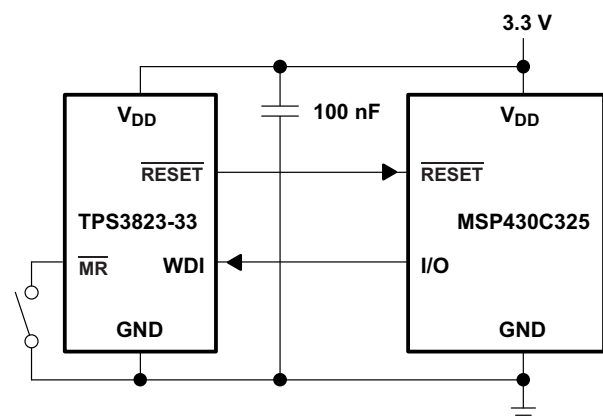

Please be aware that an important notice concerning availability, standard warranty, and use in critical applications of Texas Instruments semiconductor products and disclaimers thereto appears at the end of this data sheet.

All trademarks are the property of their respective owners.



These devices have limited built-in ESD protection. The leads should be shorted together or the device placed in conductive foam during storage or handling to prevent electrostatic damage to the MOS gates.

DESCRIPTION (CONTINUED)

The TPS3820/3/5/8 devices incorporate a manual reset input, \overline{MR} . A low level at \overline{MR} causes \overline{RESET} to become active. The TPS3824/5 devices include a high-level output RESET. TPS3820/3/4/8 have a watchdog timer that is periodically triggered by a positive or negative transition at WDI. When the supervising system fails to retrigger the watchdog circuit within the time-out interval, t_{out} , \overline{RESET} becomes active for the time period t_d . This event also reinitializes the watchdog timer. Leaving WDI unconnected disables the watchdog. In applications where the input to the WDI pin may be active (transitioning high and low) when the TPS3820/3/4/8 is asserting RESET, the TPS3820/3/4/8 does not return to a non-reset state when the input voltage is above V_T .

If the application requires that input to WDI is active when RESET pin is asserted, then the “A” version of the device should be used. The “A” versions will not latch the RESET to the asserted state if a WDI pulse is received while RESET is asserted.

Figure 1 shows how to decouple WDI from the active signal using when using the non-“A” version. This is accomplished with an N-Channel FET in series with the WDI pin, with the gate of the FET connected to the RESET output. The “A” version of the device does not need this FET but will operate in circuits that have it. Therefore, the “A” version is backward compatible with the non-“A” versions.

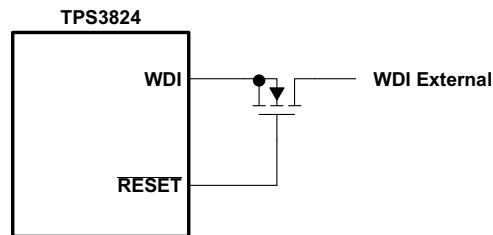

Figure 1.

The product spectrum is designed for supply voltages of 2.5 V, 3 V, 3.3 V, and 5 V. The circuits are available in an SOT23-5 package. The TPS382x devices are characterized for operation over a temperature range of -40°C to 85°C .

PACKAGE INFORMATION⁽¹⁾

DEVICE NAME ⁽²⁾	DEVICE NAME ⁽³⁾	THRESHOLD VOLTAGE ⁽⁴⁾	MARKING
TPS3820-33DBVT	TPS3820-33DBVR	2.93 V	PDEI
TPS3820-50DBVT	TPS3820-50DBVR	4.55 V	PDDI
TPS3823-25DBVT	TPS3823-25DBVR	2.25 V	PAPI
TPS3823-30DBVT	TPS3823-30DBVR	2.63 V	PAQI
TPS3823-33DBVT	TPS3823-33DBVR	2.93 V	PARI
TPS3823-50DBVT	TPS3823-50DBVR	4.55 V	PASI
TPS3824-25DBVT	TPS3824-25DBVR	2.25 V	PATI
TPS3824-30DBVT	TPS3824-30DBVR	2.63 V	PAUI
TPS3824-33DBVT	TPS3824-33DBVR	2.93 V	PAVI
TPS3824-50DBVT	TPS3824-50DBVR	4.55 V	PAWI
TPS3825-33DBVT	TPS3825-33DBVR	2.93 V	PDGI
TPS3825-50DBVT	TPS3825-50DBVR	4.55 V	PDFI
TPS3828-33DBVT	TPS3828-33DBVR	2.93 V	PDII
TPS3828-50DBVT	TPS3828-50DBVR	4.55 V	PDHI
TPS3823A-33DBVT	TPS3823A-33DBVR	2.93 V	PYPI

- (1) For the most current package and ordering information see the Package Option Addendum at the end of this document, or see the TI web site at www.ti.com.
- (2) The DBVT package indicates tape and reel of 250 parts.
- (3) The DBVR package indicates tape and reel of 3000 parts.
- (4) For other threshold voltage versions, please contact the local TI sales office.

FUNCTION/TRUTH TABLE

INPUTS		OUTPUTS	
$\overline{MR}^{(1)}$	$V_{DD} > V_{IT}$	\overline{RESET}	RESET ⁽²⁾
L	0	L	H
L	1	L	H
H	0	L	H
H	1	H	L

(1) TPS3820/3/5/8

(2) TPS3824/5

FUNCTIONAL BLOCK DIAGRAM

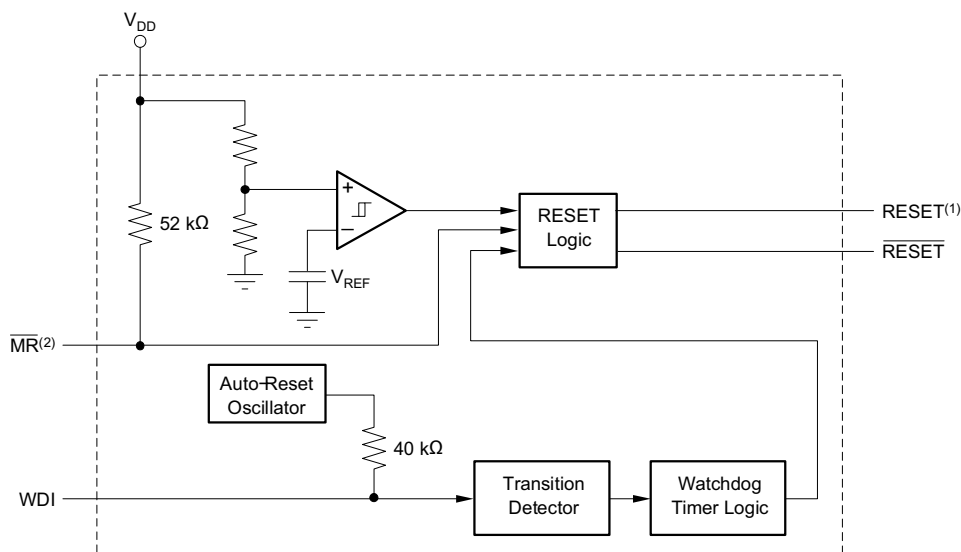

(1) TPS3824/5

(2) TPS3820/3/5/8

TIMING DIAGRAM

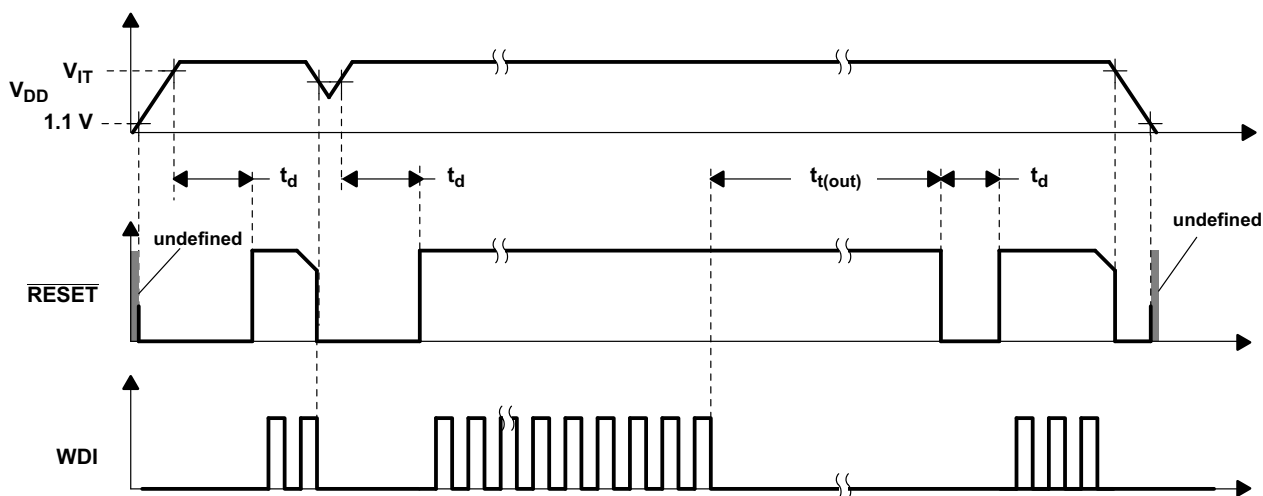

ABSOLUTE MAXIMUM RATINGS⁽¹⁾⁽²⁾

over operating free-air temperature range (unless otherwise noted)

		VALUE	UNIT
V _{DD}	Supply voltage	6 V	V
	RESET, $\overline{\text{RESET}}$, MR, WDI	-0.3 to (V _{DD} + 0.3)	V
I _{OL}	Maximum low output current	5	mA
I _{OH}	Maximum high output current	-5	mA
I _{IK}	Input clamp current range (V _I < 0 or V _I > V _{DD})	±10	mA
I _{OK}	Output clamp current range (V _O < 0 or V _O > V _{DD})	±10	mA
	Continuous total power dissipation	See Dissipation Rating Table	
T _A	Operating free-air temperature range	-40 to +85	°C
T _{stg}	Storage temperature range	-65 to +150	°C
	Soldering temperature	260	°C

- (1) Stresses beyond those listed under absolute maximum ratings may cause permanent damage to the device. These are stress ratings only, and functional operation of the device at these or any other conditions beyond those indicated under recommended operating conditions is not implied. Exposure to absolute-maximum-rated conditions for extended periods may affect device reliability.
- (2) All voltage values are with respect to GND.

DISSIPATION RATINGS

PACKAGE	T _A ≤ 25°C POWER RATING	OPERATING FACTOR ABOVE T _A = 25°C	T _A = 70°C POWER RATING	T _A = 85°C POWER RATING
DBV	437 mW	3.5 mW/°C	280 mW	227 mW

RECOMMENDED OPERATING CONDITIONS

over operating free-air temperature range (unless otherwise noted)

		MIN	MAX	UNIT
V _{DD}	Supply voltage	1.1	5.5	V
V _I	Input voltage	0	V _{DD} + 0.3	V
V _{IH}	High-level input voltage at $\overline{\text{MR}}$ and $\overline{\text{WDI}}$	0.7 × V _{DD}		V
V _{IL}	Low-level input voltage	0.3 × V _{DD}		V
Δt/ΔV	Input transition rise and fall rate at $\overline{\text{MR}}$ or $\overline{\text{WDI}}$	100		ns/V
T _A	Operating free-air temperature range	-40	85	°C

ELECTRICAL CHARACTERISTICS

over operating free-air temperature range (unless otherwise noted)

PARAMETER		TEST CONDITIONS		MIN	TYP	MAX	UNIT	
V_{OH}	$\overline{\text{RESET}}$	TPS382x-25	$V_{DD} = V_{IT-} + 0.2 \text{ V}$, $I_{OH} = -20 \mu\text{A}$	$0.8 \times V_{DD}$			V	
		TPS382x-30 TPS382x-33 TPS382xA-33	$V_{DD} = V_{IT-} + 0.2 \text{ V}$, $I_{OH} = -30 \mu\text{A}$					
	TPS382x-50	$V_{DD} = V_{IT-} + 0.2 \text{ V}$, $I_{OH} = -120 \mu\text{A}$	$V_{DD} - 1.5 \text{ V}$					
	RESET	TPS3824-25 TPS3825-25	$V_{DD} \geq 1.8 \text{ V}$, $I_{OH} = -100 \mu\text{A}$	$0.8 \times V_{DD}$				V
TPS3824-30 TPS3825-30		$V_{DD} \geq 1.8 \text{ V}$, $I_{OH} = -150 \mu\text{A}$						
TPS3824-33 TPS3825-33								
TPS3824-50 TPS3825-50								
V_{OL}	RESET		TPS3824-25 TPS3825-25	$V_{DD} = V_{IT-} + 0.2 \text{ V}$, $I_{OL} = 1 \text{ mA}$			0.4	V
		TPS3824-30 TPS3825-30	$V_{DD} = V_{IT-} + 0.2 \text{ V}$, $I_{OL} = 1.2 \text{ mA}$					
		TPS3824-33 TPS3825-33	$V_{DD} = V_{IT-} + 0.2 \text{ V}$, $I_{OL} = 3 \text{ mA}$					
		TPS3824-50 TPS3825-50						
	$\overline{\text{RESET}}$	TPS382x-25	$V_{DD} = V_{IT-} - 0.2 \text{ V}$, $I_{OL} = 1 \text{ mA}$				0.4	V
		TPS382x-30	$V_{DD} = V_{IT-} - 0.2 \text{ V}$, $I_{OL} = 1.2 \text{ mA}$					
		TPS382x-33 TPS382xA-33	$V_{DD} = V_{IT-} - 0.2 \text{ V}$, $I_{OL} = 3 \text{ mA}$					
		TPS382x-50						
Power-up reset voltage ⁽¹⁾			$V_{DD} \geq 1.1 \text{ V}$, $I_{OL} = 20 \mu\text{A}$			0.4	V	
V_{IT-}	Negative-going input threshold voltage ⁽²⁾	TPS382x-25	$T_A = 0^\circ\text{C}$ to $+85^\circ\text{C}$	2.21	2.25	2.30	V	
		TPS382x-30		2.59	2.63	2.69		
		TPS382x-33 TPS382xA-33		2.88	2.93	3		
		TPS382x-50		4.49	4.55	4.64		
			TPS382x-25	$T_A = -40^\circ\text{C}$ to $+85^\circ\text{C}$	2.20	2.25	2.30	V
			TPS382x-30		2.57	2.63	2.69	
			TPS382x-33 TPS382xA-33		2.86	2.93	3	
			TPS382x-50		4.46	4.55	4.64	
V_{hys}	Hysteresis at V_{DD} input	TPS382x-25			30		mV	
		TPS382x-30						
		TPS382x-33 TPS382xA-33						
		TPS382x-50						50
$I_{IH(AV)}$	Average high-level input current	WDI	$WDI = V_{DD}$, time average (dc = 88%)	120			μA	
$I_{IL(AV)}$	Average low-level input current		$WDI = 0.3 \text{ V}$, $V_{DD} = 5.5 \text{ V}$ time average (dc = 12%)	-15				
I_{IH}	High-level input current	WDI	$WDI = V_{DD}$	140	190		μA	
		$\overline{\text{MR}}$	$\overline{\text{MR}} = V_{DD} \times 0.7$, $V_{DD} = 5.5 \text{ V}$	-40	-60			
I_{IL}	Low-level input current	WDI	$WDI = 0.3 \text{ V}$, $V_{DD} = 5.5 \text{ V}$	140	190		μA	
		$\overline{\text{MR}}$	$\overline{\text{MR}} = 0.3 \text{ V}$, $V_{DD} = 5.5 \text{ V}$	-110	-160			

(1) The lowest supply voltage at which $\overline{\text{RESET}}$ becomes active. t_r , $V_{DD} \geq 15 \mu\text{s/V}$.

(2) To ensure best stability of the threshold voltage, a bypass capacitor (ceramic, $0.1 \mu\text{F}$) should be placed near the supply terminals.

ELECTRICAL CHARACTERISTICS (continued)

over operating free-air temperature range (unless otherwise noted)

PARAMETER		TEST CONDITIONS	MIN	TYP	MAX	UNIT	
I_{OS}	Output short-circuit current ⁽³⁾	\overline{RESET} $V_{DD} = V_{IT, max} + 0.2 V, V_O = 0 V$			-400	μA	
							TPS382x-25
							TPS382x-30
							TPS382x-33
							TPS382xA-33
					-800		
I_{DD}	Supply current	WDI, \overline{MR} , and Outputs unconnected		15	25	μA	
	Internal pullup resistor at \overline{MR}			52		k Ω	
C_i	Input capacitance at \overline{MR} , WDI	$V_i = 0 V$ to 5.5 V		5		pF	

(3) The \overline{RESET} short-circuit current is the maximum pullup current when \overline{RESET} is driven low by a μP bidirectional reset pin.

TIMING REQUIREMENTS AT

At $R_L = 1 M\Omega$, $C_L = 50 pF$, $T_A = 25^\circ C$

PARAMETER		TEST CONDITIONS	MIN	MAX	UNIT
t_w	Pulse width	at VDD	$V_{DD} = V_{IT-} + 0.2 V, V_{DD} = V_{IT-} - 0.2 V$	6	μs
		at MR	$V_{DD} \geq V_{IT-} + 0.2 V, V_{IL} = 0.3 \times V_{DD}, V_{IH} = 0.7 \times V_{DD}$	1	μs
		at WDI	$V_{DD} \geq V_{IT-} + 0.2 V, V_{IL} = 0.3 \times V_{DD}, V_{IH} = 0.7 \times V_{DD}$	100	ns

SWITCHING CHARACTERISTICS

At $R_L = 1 M\Omega$, $C_L = 50 pF$, $T_A = 25^\circ C$

PARAMETER		TEST CONDITIONS	MIN	TYP	MAX	UNIT	
t_{out}	Watchdog time out	TPS3820	$V_{DD} \geq V_{IT-} + 0.2 V,$ See timing diagram	112	200	300	ms
		TPS3823/4/8, TPS3823A		0.9	1.6	2.5	s
t_d	Delay time	TPS3820	$V_{DD} \geq V_{IT-} + 0.2 V,$ See timing diagram	15	25	37	ms
		TPS3823/4/5/8, TPS3823A		120	200	300	
t_{PHL}	Propagation (delay) time, high-to-low-level output	\overline{MR} to \overline{RESET} delay (TPS3820/3/5/8, TPS3823A)	$V_{DD} \geq V_{IT-} + 0.2 V,$ $V_{IL} = 0.3 \times V_{DD},$ $V_{IH} = 0.7 \times V_{DD}$			0.1	μs
		V_{DD} to \overline{RESET} delay	$V_{IL} = V_{IT-} - 0.2 V,$ $V_{IH} = V_{IT-} + 0.2 V$			25	
t_{PLH}	Propagation (delay) time, low-to-high-level output	\overline{MR} to RESET delay (TPS3824/5)	$V_{DD} \geq V_{IT-} + 0.2 V,$ $V_{IL} = 0.3 \times V_{DD},$ $V_{IH} = 0.7 \times V_{DD}$			0.1	μs
		V_{DD} to RESET delay (TPS3824/5)	$V_{IL} = V_{IT-} - 0.2 V,$ $V_{IH} = V_{IT-} + 0.2 V$			25	

TYPICAL CHARACTERISTICS

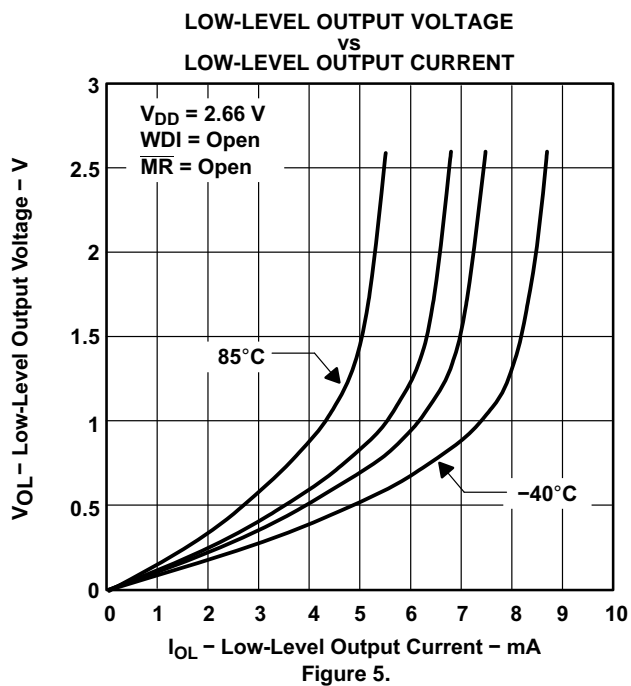
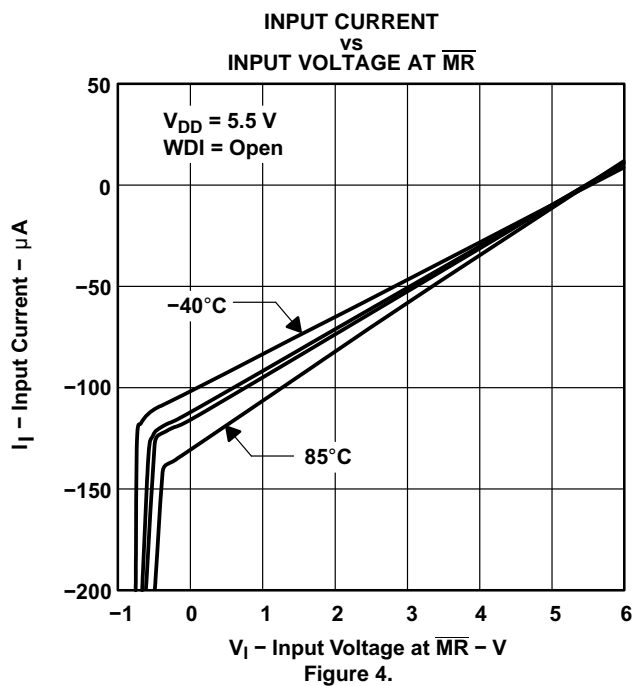
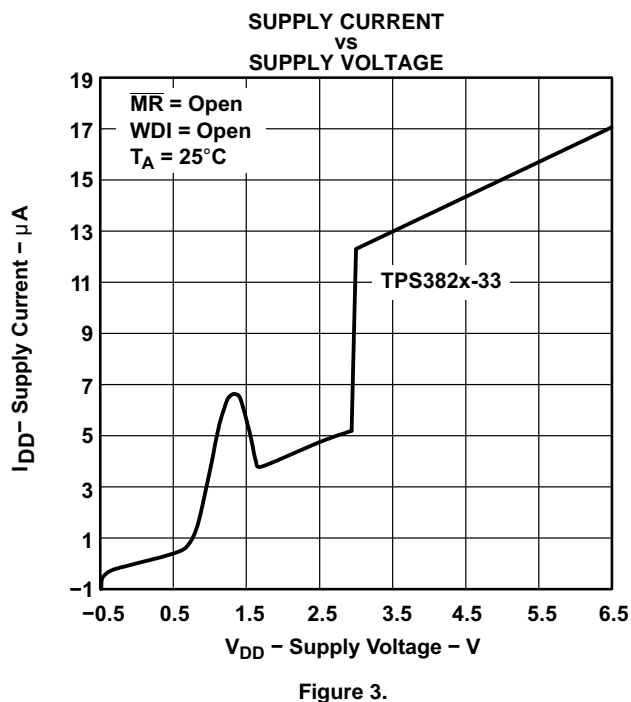
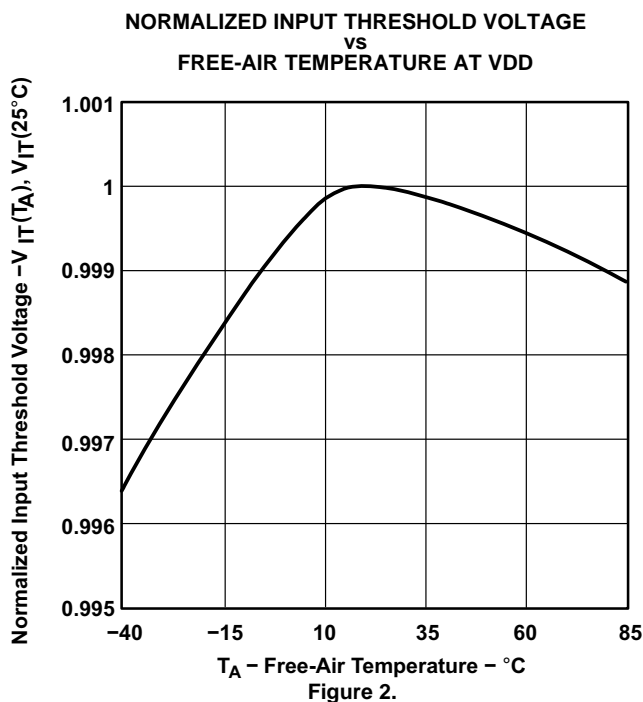

TYPICAL CHARACTERISTICS (continued)

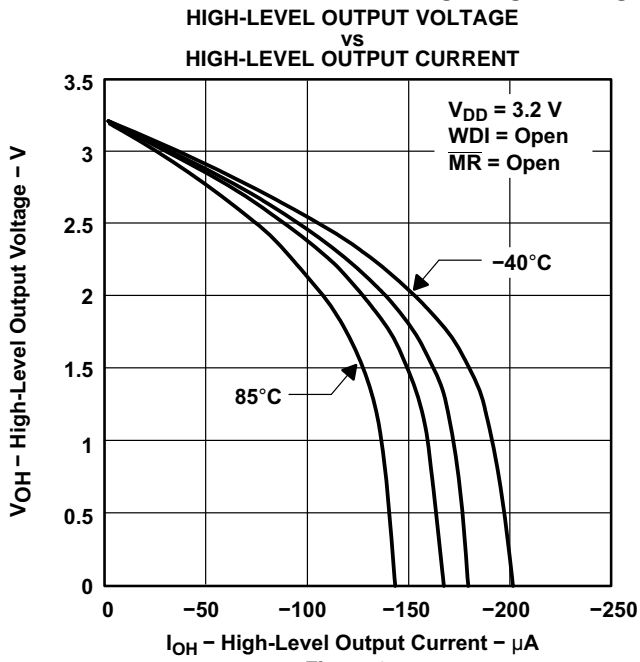

Figure 6.

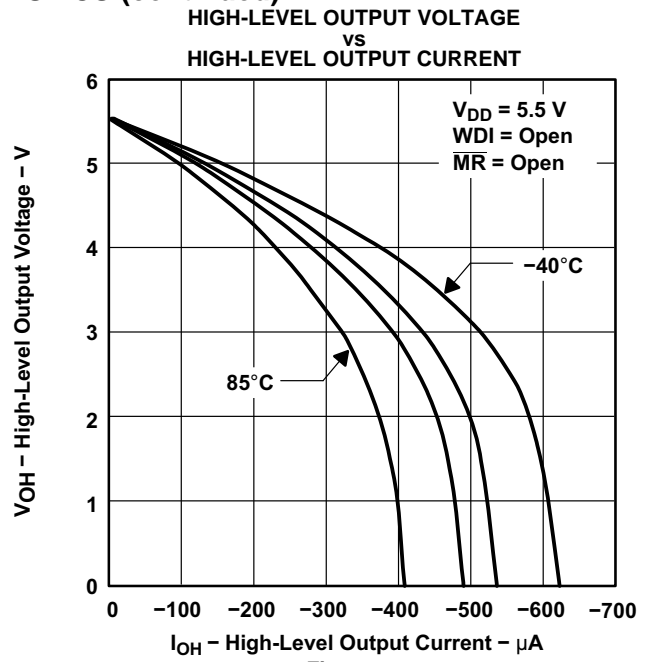

Figure 7.

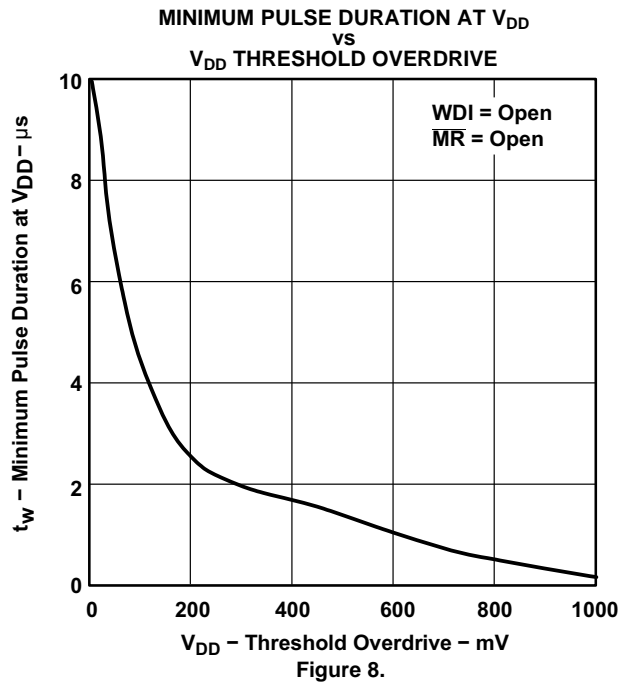

Figure 8.

REVISION HISTORY

NOTE: Page numbers for previous revisions may differ from page numbers in the current version.

Changes from Revision I (February 2013) to Revision J	Page
• Added <i>TPS382xA-33</i> to second $\overline{\text{RESET}}$ row of V_{OH} parameter in Electrical Characteristics table	5
• Added <i>TPS382xA-33</i> to third $\overline{\text{RESET}}$ row of V_{OL} parameter in Electrical Characteristics table	5
• Corrected typo in V_{OL} RESET parameter test conditions	5
• Added <i>TPS382xA-33</i> to third and seventh rows of V_{IT-} parameter in Electrical Characteristics table	5
• Added <i>TPS382xA-33</i> to third row of V_{hys} parameter in Electrical Characteristics table	5
• Added <i>TPS382xA-33</i> to third row of I_{OS} parameter in Electrical Characteristics table	6
• Added <i>TPS3823A</i> to second row of t_{out} parameter in Switching Characteristics table	6
• Added <i>TPS3823A</i> to second row of t_d parameter in Switching Characteristics table	6
• Added <i>TPS3823A</i> to first row of t_{PHL} parameter in Switching Characteristics table	6
<hr/>	
Changes from Revision H (July 2012) to Revision I	Page
• Added last row to Package Information table	2

PACKAGING INFORMATION

Orderable Device	Status (1)	Package Type	Package Drawing	Pins	Package Qty	Eco Plan (2)	Lead/Ball Finish (6)	MSL Peak Temp (3)	Op Temp (°C)	Device Marking (4/5)	Samples
TPS3820-33DBVR	ACTIVE	SOT-23	DBV	5	3000	Green (RoHS & no Sb/Br)	CU NIPDAU	Level-1-260C-UNLIM	-40 to 85	PDEI	Samples
TPS3820-33DBVRG4	ACTIVE	SOT-23	DBV	5	3000	Green (RoHS & no Sb/Br)	CU NIPDAU	Level-1-260C-UNLIM	-40 to 85	PDEI	Samples
TPS3820-33DBVT	ACTIVE	SOT-23	DBV	5	250	Green (RoHS & no Sb/Br)	CU NIPDAU	Level-1-260C-UNLIM	-40 to 85	PDEI	Samples
TPS3820-33DBVTG4	ACTIVE	SOT-23	DBV	5	250	Green (RoHS & no Sb/Br)	CU NIPDAU	Level-1-260C-UNLIM	-40 to 85	PDEI	Samples
TPS3820-50DBVR	ACTIVE	SOT-23	DBV	5	3000	Green (RoHS & no Sb/Br)	CU NIPDAU	Level-1-260C-UNLIM	-40 to 85	PDDI	Samples
TPS3820-50DBVRG4	ACTIVE	SOT-23	DBV	5	3000	Green (RoHS & no Sb/Br)	CU NIPDAU	Level-1-260C-UNLIM	-40 to 85	PDDI	Samples
TPS3820-50DBVT	ACTIVE	SOT-23	DBV	5	250	Green (RoHS & no Sb/Br)	CU NIPDAU	Level-1-260C-UNLIM	-40 to 85	PDDI	Samples
TPS3820-50DBVTG4	ACTIVE	SOT-23	DBV	5	250	Green (RoHS & no Sb/Br)	CU NIPDAU	Level-1-260C-UNLIM	-40 to 85	PDDI	Samples
TPS3823-25DBVR	ACTIVE	SOT-23	DBV	5	3000	Green (RoHS & no Sb/Br)	CU NIPDAU	Level-1-260C-UNLIM	-40 to 85	PAPI	Samples
TPS3823-25DBVRG4	ACTIVE	SOT-23	DBV	5	3000	Green (RoHS & no Sb/Br)	CU NIPDAU	Level-1-260C-UNLIM	-40 to 85	PAPI	Samples
TPS3823-25DBVT	ACTIVE	SOT-23	DBV	5	250	Green (RoHS & no Sb/Br)	CU NIPDAU	Level-1-260C-UNLIM		PAPI	Samples
TPS3823-25DBVTG4	ACTIVE	SOT-23	DBV	5	250	Green (RoHS & no Sb/Br)	CU NIPDAU	Level-1-260C-UNLIM		PAPI	Samples
TPS3823-30DBVR	ACTIVE	SOT-23	DBV	5	3000	Green (RoHS & no Sb/Br)	CU NIPDAU	Level-1-260C-UNLIM	-40 to 85	PAQI	Samples
TPS3823-30DBVRG4	ACTIVE	SOT-23	DBV	5	3000	Green (RoHS & no Sb/Br)	CU NIPDAU	Level-1-260C-UNLIM	-40 to 85	PAQI	Samples
TPS3823-30DBVT	ACTIVE	SOT-23	DBV	5	250	Green (RoHS & no Sb/Br)	CU NIPDAU	Level-1-260C-UNLIM		PAQI	Samples
TPS3823-30DBVTG4	ACTIVE	SOT-23	DBV	5	250	Green (RoHS & no Sb/Br)	CU NIPDAU	Level-1-260C-UNLIM		PAQI	Samples
TPS3823-33DBVR	ACTIVE	SOT-23	DBV	5	3000	Green (RoHS & no Sb/Br)	CU NIPDAU	Level-1-260C-UNLIM	-40 to 85	PARI	Samples

Orderable Device	Status (1)	Package Type	Package Drawing	Pins	Package Qty	Eco Plan (2)	Lead/Ball Finish (6)	MSL Peak Temp (3)	Op Temp (°C)	Device Marking (4/5)	Samples
TPS3823-33DBVRG4	ACTIVE	SOT-23	DBV	5	3000	Green (RoHS & no Sb/Br)	CU NIPDAU	Level-1-260C-UNLIM	-40 to 85	PARI	Samples
TPS3823-33DBVT	ACTIVE	SOT-23	DBV	5	250	Green (RoHS & no Sb/Br)	CU NIPDAU	Level-1-260C-UNLIM		PARI	Samples
TPS3823-33DBVTG4	ACTIVE	SOT-23	DBV	5	250	Green (RoHS & no Sb/Br)	CU NIPDAU	Level-1-260C-UNLIM		PARI	Samples
TPS3823-50DBVR	ACTIVE	SOT-23	DBV	5	3000	Green (RoHS & no Sb/Br)	CU NIPDAU	Level-1-260C-UNLIM	-40 to 85	PASI	Samples
TPS3823-50DBVRG4	ACTIVE	SOT-23	DBV	5	3000	Green (RoHS & no Sb/Br)	CU NIPDAU	Level-1-260C-UNLIM	-40 to 85	PASI	Samples
TPS3823-50DBVT	ACTIVE	SOT-23	DBV	5	250	Green (RoHS & no Sb/Br)	CU NIPDAU	Level-1-260C-UNLIM		PASI	Samples
TPS3823-50DBVTG4	ACTIVE	SOT-23	DBV	5	250	Green (RoHS & no Sb/Br)	CU NIPDAU	Level-1-260C-UNLIM		PASI	Samples
TPS3823A-33DBVR	ACTIVE	SOT-23	DBV	5	3000	Green (RoHS & no Sb/Br)	CU NIPDAU	Level-1-260C-UNLIM	-40 to 85	PYPI	Samples
TPS3823A-33DBVT	ACTIVE	SOT-23	DBV	5	250	Green (RoHS & no Sb/Br)	CU NIPDAU	Level-1-260C-UNLIM	-40 to 85	PYPI	Samples
TPS3824-25DBVR	ACTIVE	SOT-23	DBV	5	3000	Green (RoHS & no Sb/Br)	CU NIPDAU	Level-1-260C-UNLIM	-40 to 85	PATI	Samples
TPS3824-25DBVRG4	ACTIVE	SOT-23	DBV	5	3000	Green (RoHS & no Sb/Br)	CU NIPDAU	Level-1-260C-UNLIM	-40 to 85	PATI	Samples
TPS3824-25DBVT	ACTIVE	SOT-23	DBV	5	250	Green (RoHS & no Sb/Br)	CU NIPDAU	Level-1-260C-UNLIM		PATI	Samples
TPS3824-25DBVTG4	ACTIVE	SOT-23	DBV	5	250	Green (RoHS & no Sb/Br)	CU NIPDAU	Level-1-260C-UNLIM		PATI	Samples
TPS3824-30DBVR	ACTIVE	SOT-23	DBV	5	3000	Green (RoHS & no Sb/Br)	CU NIPDAU	Level-1-260C-UNLIM	-40 to 85	PAUI	Samples
TPS3824-30DBVRG4	ACTIVE	SOT-23	DBV	5	3000	Green (RoHS & no Sb/Br)	CU NIPDAU	Level-1-260C-UNLIM	-40 to 85	PAUI	Samples
TPS3824-30DBVT	ACTIVE	SOT-23	DBV	5	250	Green (RoHS & no Sb/Br)	CU NIPDAU	Level-1-260C-UNLIM		PAUI	Samples
TPS3824-30DBVTG4	ACTIVE	SOT-23	DBV	5	250	Green (RoHS & no Sb/Br)	CU NIPDAU	Level-1-260C-UNLIM		PAUI	Samples
TPS3824-33DBVR	ACTIVE	SOT-23	DBV	5	3000	Green (RoHS & no Sb/Br)	CU NIPDAU	Level-1-260C-UNLIM	-40 to 85	PAVI	Samples

Orderable Device	Status (1)	Package Type	Package Drawing	Pins	Package Qty	Eco Plan (2)	Lead/Ball Finish (6)	MSL Peak Temp (3)	Op Temp (°C)	Device Marking (4/5)	Samples
TPS3824-33DBVRG4	ACTIVE	SOT-23	DBV	5	3000	Green (RoHS & no Sb/Br)	CU NIPDAU	Level-1-260C-UNLIM	-40 to 85	PAVI	Samples
TPS3824-33DBVT	ACTIVE	SOT-23	DBV	5	250	Green (RoHS & no Sb/Br)	CU NIPDAU	Level-1-260C-UNLIM		PAVI	Samples
TPS3824-33DBVTG4	ACTIVE	SOT-23	DBV	5	250	Green (RoHS & no Sb/Br)	CU NIPDAU	Level-1-260C-UNLIM		PAVI	Samples
TPS3824-50DBVR	ACTIVE	SOT-23	DBV	5	3000	Green (RoHS & no Sb/Br)	CU NIPDAU	Level-1-260C-UNLIM	-40 to 85	PAWI	Samples
TPS3824-50DBVRG4	ACTIVE	SOT-23	DBV	5	3000	Green (RoHS & no Sb/Br)	CU NIPDAU	Level-1-260C-UNLIM	-40 to 85	PAWI	Samples
TPS3824-50DBVT	ACTIVE	SOT-23	DBV	5	250	Green (RoHS & no Sb/Br)	CU NIPDAU	Level-1-260C-UNLIM		PAWI	Samples
TPS3824-50DBVTG4	ACTIVE	SOT-23	DBV	5	250	Green (RoHS & no Sb/Br)	CU NIPDAU	Level-1-260C-UNLIM		PAWI	Samples
TPS3825-33DBVR	ACTIVE	SOT-23	DBV	5	3000	Green (RoHS & no Sb/Br)	CU NIPDAU	Level-1-260C-UNLIM	-40 to 85	PDGI	Samples
TPS3825-33DBVRG4	ACTIVE	SOT-23	DBV	5	3000	Green (RoHS & no Sb/Br)	CU NIPDAU	Level-1-260C-UNLIM	-40 to 85	PDGI	Samples
TPS3825-33DBVT	ACTIVE	SOT-23	DBV	5	250	Green (RoHS & no Sb/Br)	CU NIPDAU	Level-1-260C-UNLIM	-40 to 85	PDGI	Samples
TPS3825-33DBVTG4	ACTIVE	SOT-23	DBV	5	250	Green (RoHS & no Sb/Br)	CU NIPDAU	Level-1-260C-UNLIM	-40 to 85	PDGI	Samples
TPS3825-50DBVR	ACTIVE	SOT-23	DBV	5	3000	Green (RoHS & no Sb/Br)	CU NIPDAU	Level-1-260C-UNLIM	-40 to 85	PDFI	Samples
TPS3825-50DBVRG4	ACTIVE	SOT-23	DBV	5	3000	Green (RoHS & no Sb/Br)	CU NIPDAU	Level-1-260C-UNLIM	-40 to 85	PDFI	Samples
TPS3825-50DBVT	ACTIVE	SOT-23	DBV	5	250	Green (RoHS & no Sb/Br)	CU NIPDAU	Level-1-260C-UNLIM	-40 to 85	PDFI	Samples
TPS3825-50DBVTG4	ACTIVE	SOT-23	DBV	5	250	Green (RoHS & no Sb/Br)	CU NIPDAU	Level-1-260C-UNLIM	-40 to 85	PDFI	Samples
TPS3828-33DBVR	ACTIVE	SOT-23	DBV	5	3000	Green (RoHS & no Sb/Br)	CU NIPDAU	Level-1-260C-UNLIM	-40 to 85	PDII	Samples
TPS3828-33DBVRG4	ACTIVE	SOT-23	DBV	5	3000	Green (RoHS & no Sb/Br)	CU NIPDAU	Level-1-260C-UNLIM	-40 to 85	PDII	Samples
TPS3828-33DBVT	ACTIVE	SOT-23	DBV	5	250	Green (RoHS & no Sb/Br)	CU NIPDAU	Level-1-260C-UNLIM	-40 to 85	PDII	Samples

Orderable Device	Status (1)	Package Type	Package Drawing	Pins	Package Qty	Eco Plan (2)	Lead/Ball Finish (6)	MSL Peak Temp (3)	Op Temp (°C)	Device Marking (4/5)	Samples
TPS3828-33DBVTG4	ACTIVE	SOT-23	DBV	5	250	Green (RoHS & no Sb/Br)	CU NIPDAU	Level-1-260C-UNLIM	-40 to 85	PDII	Samples
TPS3828-50DBVR	ACTIVE	SOT-23	DBV	5	3000	Green (RoHS & no Sb/Br)	CU NIPDAU	Level-1-260C-UNLIM	-40 to 85	PDHI	Samples
TPS3828-50DBVRG4	ACTIVE	SOT-23	DBV	5	3000	Green (RoHS & no Sb/Br)	CU NIPDAU	Level-1-260C-UNLIM	-40 to 85	PDHI	Samples
TPS3828-50DBVT	ACTIVE	SOT-23	DBV	5	250	Green (RoHS & no Sb/Br)	CU NIPDAU	Level-1-260C-UNLIM	-40 to 85	PDHI	Samples
TPS3828-50DBVTG4	ACTIVE	SOT-23	DBV	5	250	Green (RoHS & no Sb/Br)	CU NIPDAU	Level-1-260C-UNLIM	-40 to 85	PDHI	Samples

(1) The marketing status values are defined as follows:

ACTIVE: Product device recommended for new designs.

LIFEBUY: TI has announced that the device will be discontinued, and a lifetime-buy period is in effect.

NRND: Not recommended for new designs. Device is in production to support existing customers, but TI does not recommend using this part in a new design.

PREVIEW: Device has been announced but is not in production. Samples may or may not be available.

OBSELETE: TI has discontinued the production of the device.

(2) Eco Plan - The planned eco-friendly classification: Pb-Free (RoHS), Pb-Free (RoHS Exempt), or Green (RoHS & no Sb/Br) - please check <http://www.ti.com/productcontent> for the latest availability information and additional product content details.

TBD: The Pb-Free/Green conversion plan has not been defined.

Pb-Free (RoHS): TI's terms "Lead-Free" or "Pb-Free" mean semiconductor products that are compatible with the current RoHS requirements for all 6 substances, including the requirement that lead not exceed 0.1% by weight in homogeneous materials. Where designed to be soldered at high temperatures, TI Pb-Free products are suitable for use in specified lead-free processes.

Pb-Free (RoHS Exempt): This component has a RoHS exemption for either 1) lead-based flip-chip solder bumps used between the die and package, or 2) lead-based die adhesive used between the die and leadframe. The component is otherwise considered Pb-Free (RoHS compatible) as defined above.

Green (RoHS & no Sb/Br): TI defines "Green" to mean Pb-Free (RoHS compatible), and free of Bromine (Br) and Antimony (Sb) based flame retardants (Br or Sb do not exceed 0.1% by weight in homogeneous material)

(3) MSL, Peak Temp. - The Moisture Sensitivity Level rating according to the JEDEC industry standard classifications, and peak solder temperature.

(4) There may be additional marking, which relates to the logo, the lot trace code information, or the environmental category on the device.

(5) Multiple Device Markings will be inside parentheses. Only one Device Marking contained in parentheses and separated by a "~" will appear on a device. If a line is indented then it is a continuation of the previous line and the two combined represent the entire Device Marking for that device.

(6) Lead/Ball Finish - Orderable Devices may have multiple material finish options. Finish options are separated by a vertical ruled line. Lead/Ball Finish values may wrap to two lines if the finish value exceeds the maximum column width.

Important Information and Disclaimer: The information provided on this page represents TI's knowledge and belief as of the date that it is provided. TI bases its knowledge and belief on information provided by third parties, and makes no representation or warranty as to the accuracy of such information. Efforts are underway to better integrate information from third parties. TI has taken and continues to take reasonable steps to provide representative and accurate information but may not have conducted destructive testing or chemical analysis on incoming materials and chemicals. TI and TI suppliers consider certain information to be proprietary, and thus CAS numbers and other limited information may not be available for release.

In no event shall TI's liability arising out of such information exceed the total purchase price of the TI part(s) at issue in this document sold by TI to Customer on an annual basis.

OTHER QUALIFIED VERSIONS OF TPS3820-33, TPS3820-50, TPS3823-25, TPS3823-30, TPS3823-33, TPS3823-50, TPS3824-25, TPS3824-30, TPS3824-33, TPS3824-50, TPS3825-33, TPS3825-50, TPS3828-33, TPS3828-50 :

● Automotive: [TPS3820-33-Q1](#), [TPS3820-50-Q1](#), [TPS3823-25-Q1](#), [TPS3823-30-Q1](#), [TPS3823-33-Q1](#), [TPS3823-50-Q1](#), [TPS3824-25-Q1](#), [TPS3824-30-Q1](#), [TPS3824-33-Q1](#), [TPS3824-50-Q1](#), [TPS3825-33-Q1](#), [TPS3825-50-Q1](#), [TPS3828-33-Q1](#), [TPS3828-50-Q1](#)

NOTE: Qualified Version Definitions:

- Automotive - Q100 devices qualified for high-reliability automotive applications targeting zero defects

TAPE AND REEL INFORMATION



QUADRANT ASSIGNMENTS FOR PIN 1 ORIENTATION IN TAPE



*All dimensions are nominal

Device	Package Type	Package Drawing	Pins	SPQ	Reel Diameter (mm)	Reel Width W1 (mm)	A0 (mm)	B0 (mm)	K0 (mm)	P1 (mm)	W (mm)	Pin1 Quadrant
TPS3820-33DBVR	SOT-23	DBV	5	3000	178.0	9.0	3.3	3.2	1.4	4.0	8.0	Q3
TPS3820-33DBVT	SOT-23	DBV	5	250	178.0	9.0	3.23	3.17	1.37	4.0	8.0	Q3
TPS3820-50DBVR	SOT-23	DBV	5	3000	179.0	8.4	3.2	3.2	1.4	4.0	8.0	Q3
TPS3820-50DBVT	SOT-23	DBV	5	3000	178.0	9.0	3.23	3.17	1.37	4.0	8.0	Q3
TPS3820-50DBVT	SOT-23	DBV	5	250	178.0	9.0	3.23	3.17	1.37	4.0	8.0	Q3
TPS3820-50DBVT	SOT-23	DBV	5	250	179.0	8.4	3.2	3.2	1.4	4.0	8.0	Q3
TPS3823-25DBVR	SOT-23	DBV	5	3000	179.0	8.4	3.2	3.2	1.4	4.0	8.0	Q3
TPS3823-25DBVT	SOT-23	DBV	5	3000	178.0	9.0	3.23	3.17	1.37	4.0	8.0	Q3
TPS3823-25DBVT	SOT-23	DBV	5	250	178.0	9.0	3.23	3.17	1.37	4.0	8.0	Q3
TPS3823-25DBVT	SOT-23	DBV	5	250	179.0	8.4	3.2	3.2	1.4	4.0	8.0	Q3
TPS3823-30DBVR	SOT-23	DBV	5	3000	178.0	9.0	3.23	3.17	1.37	4.0	8.0	Q3
TPS3823-30DBVT	SOT-23	DBV	5	250	178.0	9.0	3.23	3.17	1.37	4.0	8.0	Q3
TPS3823-33DBVR	SOT-23	DBV	5	3000	178.0	9.0	3.23	3.17	1.37	4.0	8.0	Q3
TPS3823-33DBVT	SOT-23	DBV	5	250	178.0	9.0	3.3	3.2	1.4	4.0	8.0	Q3
TPS3823-50DBVR	SOT-23	DBV	5	3000	178.0	9.0	3.23	3.17	1.37	4.0	8.0	Q3
TPS3823-50DBVT	SOT-23	DBV	5	250	178.0	9.0	3.23	3.17	1.37	4.0	8.0	Q3
TPS3823A-33DBVR	SOT-23	DBV	5	3000	178.0	9.0	3.3	3.2	1.4	4.0	8.0	Q3
TPS3823A-33DBVT	SOT-23	DBV	5	250	178.0	9.0	3.23	3.17	1.37	4.0	8.0	Q3

Device	Package Type	Package Drawing	Pins	SPQ	Reel Diameter (mm)	Reel Width W1 (mm)	A0 (mm)	B0 (mm)	K0 (mm)	P1 (mm)	W (mm)	Pin1 Quadrant
TPS3824-25DBVR	SOT-23	DBV	5	3000	178.0	9.0	3.23	3.17	1.37	4.0	8.0	Q3
TPS3824-25DBVR	SOT-23	DBV	5	3000	179.0	8.4	3.2	3.2	1.4	4.0	8.0	Q3
TPS3824-25DBVT	SOT-23	DBV	5	250	179.0	8.4	3.2	3.2	1.4	4.0	8.0	Q3
TPS3824-25DBVT	SOT-23	DBV	5	250	178.0	9.0	3.23	3.17	1.37	4.0	8.0	Q3
TPS3824-30DBVR	SOT-23	DBV	5	3000	178.0	9.0	3.23	3.17	1.37	4.0	8.0	Q3
TPS3824-30DBVR	SOT-23	DBV	5	3000	179.0	8.4	3.2	3.2	1.4	4.0	8.0	Q3
TPS3824-30DBVT	SOT-23	DBV	5	250	178.0	9.0	3.23	3.17	1.37	4.0	8.0	Q3
TPS3824-30DBVT	SOT-23	DBV	5	250	179.0	8.4	3.2	3.2	1.4	4.0	8.0	Q3
TPS3824-33DBVR	SOT-23	DBV	5	3000	178.0	9.0	3.23	3.17	1.37	4.0	8.0	Q3
TPS3824-33DBVT	SOT-23	DBV	5	250	178.0	9.0	3.3	3.2	1.4	4.0	8.0	Q3
TPS3824-50DBVR	SOT-23	DBV	5	3000	178.0	9.0	3.23	3.17	1.37	4.0	8.0	Q3
TPS3824-50DBVT	SOT-23	DBV	5	250	179.0	8.4	3.2	3.2	1.4	4.0	8.0	Q3
TPS3824-50DBVT	SOT-23	DBV	5	250	178.0	9.0	3.23	3.17	1.37	4.0	8.0	Q3
TPS3825-33DBVR	SOT-23	DBV	5	3000	178.0	9.0	3.3	3.2	1.4	4.0	8.0	Q3
TPS3825-33DBVT	SOT-23	DBV	5	250	178.0	8.4	3.23	3.17	1.37	4.0	8.0	Q3
TPS3825-50DBVR	SOT-23	DBV	5	3000	178.0	9.0	3.23	3.17	1.37	4.0	8.0	Q3
TPS3825-50DBVR	SOT-23	DBV	5	3000	179.0	8.4	3.2	3.2	1.4	4.0	8.0	Q3
TPS3825-50DBVT	SOT-23	DBV	5	250	178.0	9.0	3.3	3.2	1.4	4.0	8.0	Q3
TPS3828-33DBVR	SOT-23	DBV	5	3000	178.0	9.0	3.23	3.17	1.37	4.0	8.0	Q3
TPS3828-33DBVT	SOT-23	DBV	5	250	178.0	9.0	3.23	3.17	1.37	4.0	8.0	Q3
TPS3828-50DBVR	SOT-23	DBV	5	3000	178.0	9.0	3.23	3.17	1.37	4.0	8.0	Q3
TPS3828-50DBVT	SOT-23	DBV	5	250	178.0	9.0	3.3	3.2	1.4	4.0	8.0	Q3

TAPE AND REEL BOX DIMENSIONS

*All dimensions are nominal

Device	Package Type	Package Drawing	Pins	SPQ	Length (mm)	Width (mm)	Height (mm)
TPS3820-33DBVR	SOT-23	DBV	5	3000	180.0	180.0	18.0
TPS3820-33DBVT	SOT-23	DBV	5	250	180.0	180.0	18.0
TPS3820-50DBVR	SOT-23	DBV	5	3000	203.0	203.0	35.0
TPS3820-50DBVT	SOT-23	DBV	5	250	180.0	180.0	18.0
TPS3820-50DBVT	SOT-23	DBV	5	250	203.0	203.0	35.0
TPS3823-25DBVR	SOT-23	DBV	5	3000	203.0	203.0	35.0
TPS3823-25DBVR	SOT-23	DBV	5	3000	180.0	180.0	18.0
TPS3823-25DBVT	SOT-23	DBV	5	250	180.0	180.0	18.0
TPS3823-25DBVT	SOT-23	DBV	5	250	203.0	203.0	35.0
TPS3823-30DBVR	SOT-23	DBV	5	3000	180.0	180.0	18.0
TPS3823-30DBVT	SOT-23	DBV	5	250	180.0	180.0	18.0
TPS3823-33DBVR	SOT-23	DBV	5	3000	180.0	180.0	18.0
TPS3823-33DBVT	SOT-23	DBV	5	250	180.0	180.0	18.0
TPS3823-50DBVR	SOT-23	DBV	5	3000	180.0	180.0	18.0
TPS3823-50DBVT	SOT-23	DBV	5	250	180.0	180.0	18.0
TPS3823A-33DBVR	SOT-23	DBV	5	3000	180.0	180.0	18.0
TPS3823A-33DBVT	SOT-23	DBV	5	250	180.0	180.0	18.0
TPS3824-25DBVR	SOT-23	DBV	5	3000	180.0	180.0	18.0
TPS3824-25DBVR	SOT-23	DBV	5	3000	203.0	203.0	35.0

Device	Package Type	Package Drawing	Pins	SPQ	Length (mm)	Width (mm)	Height (mm)
TPS3824-25DBVT	SOT-23	DBV	5	250	203.0	203.0	35.0
TPS3824-25DBVT	SOT-23	DBV	5	250	180.0	180.0	18.0
TPS3824-30DBVR	SOT-23	DBV	5	3000	180.0	180.0	18.0
TPS3824-30DBVR	SOT-23	DBV	5	3000	203.0	203.0	35.0
TPS3824-30DBVT	SOT-23	DBV	5	250	180.0	180.0	18.0
TPS3824-30DBVT	SOT-23	DBV	5	250	203.0	203.0	35.0
TPS3824-33DBVR	SOT-23	DBV	5	3000	180.0	180.0	18.0
TPS3824-33DBVT	SOT-23	DBV	5	250	180.0	180.0	18.0
TPS3824-50DBVR	SOT-23	DBV	5	3000	180.0	180.0	18.0
TPS3824-50DBVT	SOT-23	DBV	5	250	203.0	203.0	35.0
TPS3824-50DBVT	SOT-23	DBV	5	250	180.0	180.0	18.0
TPS3825-33DBVR	SOT-23	DBV	5	3000	180.0	180.0	18.0
TPS3825-33DBVT	SOT-23	DBV	5	250	180.0	180.0	18.0
TPS3825-50DBVR	SOT-23	DBV	5	3000	180.0	180.0	18.0
TPS3825-50DBVR	SOT-23	DBV	5	3000	203.0	203.0	35.0
TPS3825-50DBVT	SOT-23	DBV	5	250	180.0	180.0	18.0
TPS3828-33DBVR	SOT-23	DBV	5	3000	180.0	180.0	18.0
TPS3828-33DBVT	SOT-23	DBV	5	250	180.0	180.0	18.0
TPS3828-50DBVR	SOT-23	DBV	5	3000	180.0	180.0	18.0
TPS3828-50DBVT	SOT-23	DBV	5	250	180.0	180.0	18.0

DBV (R-PDSO-G5)

PLASTIC SMALL-OUTLINE PACKAGE



- NOTES:
- A. All linear dimensions are in millimeters.
 - B. This drawing is subject to change without notice.
 - C. Body dimensions do not include mold flash or protrusion. Mold flash and protrusion shall not exceed 0.15 per side.
 - D. Falls within JEDEC MO-178 Variation AA.

DBV (R-PDSO-G5)

PLASTIC SMALL OUTLINE



- NOTES:
- A. All linear dimensions are in millimeters.
 - B. This drawing is subject to change without notice.
 - C. Customers should place a note on the circuit board fabrication drawing not to alter the center solder mask defined pad.
 - D. Publication IPC-7351 is recommended for alternate designs.
 - E. Laser cutting apertures with trapezoidal walls and also rounding corners will offer better paste release. Customers should contact their board assembly site for stencil design recommendations. Example stencil design based on a 50% volumetric metal load solder paste. Refer to IPC-7525 for other stencil recommendations.

IMPORTANT NOTICE

Texas Instruments Incorporated and its subsidiaries (TI) reserve the right to make corrections, enhancements, improvements and other changes to its semiconductor products and services per JESD46, latest issue, and to discontinue any product or service per JESD48, latest issue. Buyers should obtain the latest relevant information before placing orders and should verify that such information is current and complete. All semiconductor products (also referred to herein as "components") are sold subject to TI's terms and conditions of sale supplied at the time of order acknowledgment.

TI warrants performance of its components to the specifications applicable at the time of sale, in accordance with the warranty in TI's terms and conditions of sale of semiconductor products. Testing and other quality control techniques are used to the extent TI deems necessary to support this warranty. Except where mandated by applicable law, testing of all parameters of each component is not necessarily performed.

TI assumes no liability for applications assistance or the design of Buyers' products. Buyers are responsible for their products and applications using TI components. To minimize the risks associated with Buyers' products and applications, Buyers should provide adequate design and operating safeguards.

TI does not warrant or represent that any license, either express or implied, is granted under any patent right, copyright, mask work right, or other intellectual property right relating to any combination, machine, or process in which TI components or services are used. Information published by TI regarding third-party products or services does not constitute a license to use such products or services or a warranty or endorsement thereof. Use of such information may require a license from a third party under the patents or other intellectual property of the third party, or a license from TI under the patents or other intellectual property of TI.

Reproduction of significant portions of TI information in TI data books or data sheets is permissible only if reproduction is without alteration and is accompanied by all associated warranties, conditions, limitations, and notices. TI is not responsible or liable for such altered documentation. Information of third parties may be subject to additional restrictions.

Resale of TI components or services with statements different from or beyond the parameters stated by TI for that component or service voids all express and any implied warranties for the associated TI component or service and is an unfair and deceptive business practice. TI is not responsible or liable for any such statements.

Buyer acknowledges and agrees that it is solely responsible for compliance with all legal, regulatory and safety-related requirements concerning its products, and any use of TI components in its applications, notwithstanding any applications-related information or support that may be provided by TI. Buyer represents and agrees that it has all the necessary expertise to create and implement safeguards which anticipate dangerous consequences of failures, monitor failures and their consequences, lessen the likelihood of failures that might cause harm and take appropriate remedial actions. Buyer will fully indemnify TI and its representatives against any damages arising out of the use of any TI components in safety-critical applications.

In some cases, TI components may be promoted specifically to facilitate safety-related applications. With such components, TI's goal is to help enable customers to design and create their own end-product solutions that meet applicable functional safety standards and requirements. Nonetheless, such components are subject to these terms.

No TI components are authorized for use in FDA Class III (or similar life-critical medical equipment) unless authorized officers of the parties have executed a special agreement specifically governing such use.

Only those TI components which TI has specifically designated as military grade or "enhanced plastic" are designed and intended for use in military/aerospace applications or environments. Buyer acknowledges and agrees that any military or aerospace use of TI components which have **not** been so designated is solely at the Buyer's risk, and that Buyer is solely responsible for compliance with all legal and regulatory requirements in connection with such use.

TI has specifically designated certain components as meeting ISO/TS16949 requirements, mainly for automotive use. In any case of use of non-designated products, TI will not be responsible for any failure to meet ISO/TS16949.

Products

Audio	www.ti.com/audio
Amplifiers	amplifier.ti.com
Data Converters	dataconverter.ti.com
DLP® Products	www.dlp.com
DSP	dsp.ti.com
Clocks and Timers	www.ti.com/clocks
Interface	interface.ti.com
Logic	logic.ti.com
Power Mgmt	power.ti.com
Microcontrollers	microcontroller.ti.com
RFID	www.ti-rfid.com
OMAP Applications Processors	www.ti.com/omap
Wireless Connectivity	www.ti.com/wirelessconnectivity

Applications

Automotive and Transportation	www.ti.com/automotive
Communications and Telecom	www.ti.com/communications
Computers and Peripherals	www.ti.com/computers
Consumer Electronics	www.ti.com/consumer-apps
Energy and Lighting	www.ti.com/energy
Industrial	www.ti.com/industrial
Medical	www.ti.com/medical
Security	www.ti.com/security
Space, Avionics and Defense	www.ti.com/space-avionics-defense
Video and Imaging	www.ti.com/video

TI E2E Community

e2e.ti.com