

1.5A USB-FRIENDLY Li-Ion BATTERY CHARGER AND POWER-PATH MANAGEMENT IC

Check for Samples: [bq24072](#), [bq24073](#), [bq24074](#), [bq24075](#), [bq24079](#)

FEATURES

- **Fully Compliant USB Charger**
 - Selectable 100mA and 500mA Maximum Input Current
 - 100mA Maximum Current Limit Ensures Compliance to USB-IF Standard
 - Input based Dynamic Power Management (V_{IN} -DPM) for Protection Against Poor USB Sources
- 28V Input Rating with Overvoltage Protection
- Integrated Dynamic Power Path Management (DPPM) Function Simultaneously and Independently Powers the System and Charges the Battery
- Supports up to 1.5A Charge Current with Current Monitoring Output (ISET)
- Programmable Input Current Limit up to 1.5A for Wall Adapters
- System Output Tracks Battery Voltage (bq24072)
- Programmable Termination Current (bq24074)
- Battery Disconnect Function with SYSOFF Input (bq24075, bq24079)
- Programmable Pre-Charge and Fast-Charge Safety Timers
- Reverse Current, Short-Circuit and Thermal Protection
- NTC Thermistor Input
- Proprietary Start Up Sequence Limits Inrush Current
- Status Indication – Charging/Done, Power Good
- Small 3 mm × 3 mm 16 Lead QFN Package

APPLICATIONS

- Smart Phones
- Portable Media Players
- Portable Navigation Devices
- Low-Power Handheld Devices

DESCRIPTION

The bq2407x series of devices are integrated Li-ion linear chargers and system power path management devices targeted at space-limited portable applications. The devices operate from either a USB port or AC adapter and support charge currents up to 1.5A. The input voltage range with input overvoltage protection supports unregulated adapters. The USB input current limit accuracy and start up sequence allow the bq2407x to meet USB-IF inrush current specification. Additionally, the input dynamic power management (V_{IN} -DPM) prevents the charger from crashing incorrectly configured USB sources.

The bq2407x features dynamic power path management (DPPM) that powers the system while simultaneously and independently charging the battery. The DPPM circuit reduces the charge current when the input current limit causes the system output to fall to the DPPM threshold; thus, supplying the system load at all times while monitoring the charge current separately. This feature reduces the number of charge and discharge cycles on the battery, allows for proper charge termination and enables the system to run with a defective or absent battery pack.

Typical Application Circuit

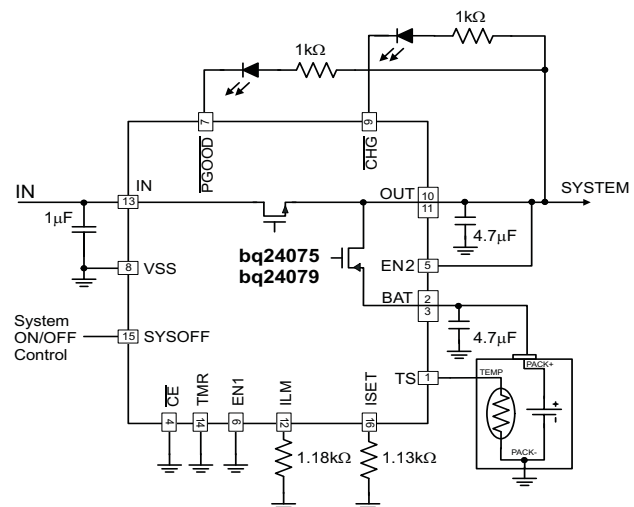

Please be aware that an important notice concerning availability, standard warranty, and use in critical applications of Texas Instruments semiconductor products and disclaimers thereto appears at the end of this data sheet.



This integrated circuit can be damaged by ESD. Texas Instruments recommends that all integrated circuits be handled with appropriate precautions. Failure to observe proper handling and installation procedures can cause damage.

ESD damage can range from subtle performance degradation to complete device failure. Precision integrated circuits may be more susceptible to damage because very small parametric changes could cause the device not to meet its published specifications.

DESCRIPTION (CONTINUED)

Additionally, the regulated system input enables instant system turn-on when plugged in even with a totally discharged battery. The power-path management architecture also permits the battery to supplement the system current requirements when the adapter cannot deliver the peak system currents, enabling the use of a smaller adapter.

The battery is charged in three phases: conditioning, constant current, and constant voltage. In all charge phases, an internal control loop monitors the IC junction temperature and reduces the charge current if the internal temperature threshold is exceeded. The charger power stage and charge current sense functions are fully integrated. The charger function has high accuracy current and voltage regulation loops, charge status display, and charge termination. The input current limit and charge current are programmable using external resistors.

ORDERING INFORMATION

PART NUMBER (1) (2)	V _{OVP}	V _{BAT(REG)}	V _{OUT(REG)}	V _{DPPM}	OPTIONAL FUNCTION	MARKING
bq24072RGTR	6.6 V	4.2V	V _{BAT} + 225 mV	V _{O(REG)} – 100 mV	TD	CKP
bq24072RGTT	6.6 V	4.2V	V _{BAT} + 225 mV	V _{O(REG)} – 100 mV	TD	CKP
bq24073RGTR	6.6 V	4.2V	4.4 V	V _{O(REG)} – 100 mV	TD	CKQ
bq24073RGTT	6.6 V	4.2V	4.4 V	V _{O(REG)} – 100 mV	TD	CKQ
bq24074RGTR	10.5 V	4.2V	4.4 V	V _{O(REG)} – 100 mV	ITERM	BZF
bq24074RGTT	10.5 V	4.2V	4.4 V	V _{O(REG)} – 100 mV	ITERM	BZF
bq24075RGTR	6.6 V	4.2V	5.5 V	4.3 V	SYSOFF	CDU
bq24075RGTT	6.6 V	4.2V	5.5 V	4.3 V	SYSOFF	CDU
bq24079RGTR	6.6 V	4.1V	5.5 V	4.3 V	SYSOFF	ODI
bq24079RGTT	6.6 V	4.1V	5.5 V	4.3 V	SYSOFF	ODI

- (1) The RGT package is available in the following options:
R - taped and reeled in quantities of 3,000 devices per reel.
T - taped and reeled in quantities of 250 devices per reel.
- (2) This product is RoHS compatible, including a lead concentration that does not exceed 0.1% of total product weight, and is suitable for use in specified lead-free soldering processes. In addition, this product uses package materials that do not contain halogens, including bromine (Br) or antimony (Sb) above 0.1% of total product weight.

ABSOLUTE MAXIMUM RATINGS⁽¹⁾

over the 0°C to 125°C operating free-air temperature range (unless otherwise noted)

			VALUE		UNIT
			MIN	MAX	
V _I	Input Voltage	IN (with respect to VSS)	-0.3	28	V
		BAT (with respect to VSS)	-0.3	5	V
		OUT, EN1, EN2, \overline{CE} , TS, ISET, \overline{PGOOD} , CHG, ILIM, TMR, ITERM, SYSOFF, TD (with respect to VSS)	-0.3	7	V
I _I	Input Current	IN		1.6	A
I _O	Output Current (Continuous)	OUT		5	A
		BAT (Discharge mode)		5	A
		BAT (Charging mode)		1.5 ⁽²⁾	A
	Output Sink Current	\overline{CHG} , \overline{PGOOD}		15	mA
Electrostatic Discharge (HBM) QSS 009-105 (JESD22-A114A) ⁽³⁾				1.5	kV
T _J	Junction temperature		-40	150	°C
T _{stg}	Storage temperature		-65	150	°C

- Stresses beyond those listed under absolute maximum ratings may cause permanent damage to the device. These are stress ratings only, and functional operation of the device at these or any other conditions beyond those indicated under recommended operating conditions is not implied. Exposure to absolute-maximum-rated conditions for extended periods may affect device reliability. All voltage values are with respect to the network ground terminal unless otherwise noted.
- The IC operational charging life is reduced to 20,000 hours, when charging at 1.5A and 125°C. The thermal regulation feature reduces charge current if the IC's junction temperature reaches 125°C; thus without a good thermal design the maximum programmed charge current may not be reached.
- The human body model is a 100-pF capacitor discharged through a 1.5-kΩ resistor into each pin.

DISSIPATION RATINGS

PACKAGE ⁽¹⁾	R _{θJA}	R _{θJC}	POWER RATING	
			T _A ≤ 25°C	T _A = 85°C
RGT ⁽²⁾	39.47 °C/W	2.4 °C/W	2.3 W	225mW

- For the most current package and ordering information, see the Package Option Addendum at the end of this document, or see the TI website at www.ti.com.
- This data is based on using the JEDEC High-K board and the exposed die pad is connected to a Cu pad on the board. The pad is connected to the ground plane by a 2x3 via matrix.

RECOMMENDED OPERATING CONDITIONS

			MIN	MAX	UNIT
V _I	IN voltage range		4.35	26	V
	IN operating voltage range	'72, '73, '75, '79	4.35	6.4	V
		'74	4.35	10.2	
I _{IN}	Input current, IN pin			1.5	A
I _{OUT}	Current, OUT pin			4.5	A
I _{BAT}	Current, BAT pin (Discharging)			4.5	A
I _{CHG}	Current, BAT pin (Charging)			1.5 ⁽¹⁾	A
T _J	Junction Temperature		-40	125	°C
R _{ILIM}	Maximum input current programming resistor		1100	8000	Ω
R _{ISET}	Fast-charge current programming resistor ⁽²⁾		590	5900	Ω
R _{ITERM}	Termination current programming resistor		0	15	kΩ
R _{TMR}	Timer programming resistor		18	72	kΩ

- The IC operational charging life is reduced to 20,000 hours, when charging at 1.5A and 125°C. The thermal regulation feature reduces charge current if the IC's junction temperature reaches 125°C; thus without a good thermal design the maximum programmed charge current may not be reached.
- Use a 1% tolerance resistor for R_{ISET} to avoid issues with the R_{ISET} short test when using the maximum charge current setting.

ELECTRICAL CHARACTERISTICS

Over junction temperature range ($0^\circ \leq T_J \leq 125^\circ\text{C}$) and the recommended supply voltage range (unless otherwise noted)

PARAMETER		TEST CONDITIONS	MIN	TYP	MAX	UNIT	
INPUT							
UVLO	Undervoltage lock-out	$V_{IN}: 0\text{ V} \rightarrow 4\text{ V}$	3.2	3.3	3.4	V	
V_{HYS}	Hysteresis on UVLO	$V_{IN}: 4\text{ V} \rightarrow 0\text{ V}$	200		300	mV	
$V_{IN(DT)}$	Input power detection threshold	Input power detected when $V_{IN} > V_{BAT} + V_{IN(DT)}$ $V_{BAT} = 3.6\text{ V}$, $V_{IN}: 3.5\text{ V} \rightarrow 4\text{ V}$	55	80	130	mV	
V_{HYS}	Hysteresis on $V_{IN(DT)}$	$V_{BAT} = 3.6\text{ V}$, $V_{IN}: 4\text{ V} \rightarrow 3.5\text{ V}$	20			mV	
$t_{DGL(PGOOD)}$	Deglintch time, input power detected status	Time measured from $V_{IN}: 0\text{ V} \rightarrow 5\text{ V}$ 1 μs rise-time to $\overline{\text{PGOOD}} = \text{LO}$		1.2		ms	
V_{OVP}	Input overvoltage protection threshold	$V_{IN}: 5\text{ V} \rightarrow 7\text{ V}$ ('72, '73, '75, '79)	6.4	6.6	6.8	V	
		$V_{IN}: 5\text{ V} \rightarrow 11\text{ V}$ ('74)	10.2	10.5	10.8		
V_{HYS}	Hysteresis on OVP	$V_{IN}: 7\text{ V} \rightarrow 5\text{ V}$ ('72, '73, '75, '79)		110		mV	
		$V_{IN}: 11\text{ V} \rightarrow 5\text{ V}$ ('74)		175			
$t_{DGL(OVP)}$	Input overvoltage blanking time (OVP fault deglitch)			50		μs	
t_{REC}	Input overvoltage recovery time	Time measured from $V_{IN}: 11\text{ V} \rightarrow 5\text{ V}$ with 1 μs fall-time to $\overline{\text{PGOOD}} = \text{LO}$		1.2		ms	
ILIM, ISET SHORT CIRCUIT DETECTION (CHECKED DURING STARTUP)							
I_{SC}	Current source	$V_{IN} > \text{UVLO}$ and $V_{IN} > V_{BAT} + V_{IN(DT)}$		1.3		mA	
V_{SC}		$V_{IN} > \text{UVLO}$ and $V_{IN} > V_{BAT} + V_{IN(DT)}$		520		mV	
QUIESCENT CURRENT							
$I_{BAT(PDWN)}$	Sleep current into BAT pin	$\overline{\text{CE}} = \text{LO}$ or HI, input power not detected, No load on OUT pin, $T_J = 85^\circ\text{C}$			6.5	μA	
I_{IN}	Standby current into IN pin	EN1= HI, EN2=HI, $V_{IN} = 6\text{ V}$, $T_J = 85^\circ\text{C}$			50	μA	
		EN1= HI, EN2=HI, $V_{IN} = 10\text{ V}$, $T_J = 85^\circ\text{C}$			200		
I_{CC}	Active supply current, IN pin	$\overline{\text{CE}} = \text{LO}$, $V_{IN} = 6\text{ V}$, no load on OUT pin, $V_{BAT} > V_{BAT(REG)}$, (EN1, EN2) \neq (HI, HI)			1.5	mA	
POWER PATH							
$V_{DO(IN-OUT)}$	$V_{IN} - V_{OUT}$	$V_{IN} = 4.3\text{ V}$, $I_{IN} = 1\text{ A}$, $V_{BAT} = 4.2\text{ V}$		300	475	mV	
$V_{DO(BAT-OUT)}$	$V_{BAT} - V_{OUT}$	$I_{OUT} = 1\text{ A}$, $V_{IN} = 0\text{ V}$, $V_{BAT} > 3\text{ V}$		50	100	mV	
$V_{O(REG)}$	OUT pin voltage regulation (bq24072)	$V_{IN} > V_{OUT} + V_{DO(IN-OUT)}$, $V_{BAT} < 3.2\text{ V}$	3.3	3.4	3.5	V	
		$V_{IN} > V_{OUT} + V_{DO(IN-OUT)}$, $V_{BAT} \geq 3.2\text{ V}$	$V_{BAT} + 150\text{mV}$	$V_{BAT} + 225\text{mV}$	$V_{BAT} + 270\text{mV}$		
	OUT pin voltage regulation (bq24073, bq24074)	$V_{IN} > V_{OUT} + V_{DO(IN-OUT)}$	4.3	4.4	4.5		
	OUT pin voltage regulation (bq24075, bq24079)	$V_{IN} > V_{OUT} + V_{DO(IN-OUT)}$	5.4	5.5	5.6		
I_{INmax}	Maximum input current	EN1 = LO, EN2 = LO	90	95	100	mA	
		EN1 = HI, EN2 = LO	450	475	500		
		EN2 = HI, EN1 = LO		K_{ILIM}/R_{ILIM}			
K_{ILIM}	Maximum input current factor	$I_{LIM} = 500\text{mA}$ to 1.5A	1500	1610	1720	A Ω	
		$I_{LIM} = 200\text{mA}$ to 500mA	1330	1525	1720		
I_{INmax}	Programmable input current limit range	EN2 = HI, EN1 = LO, $R_{ILIM} = 8\text{ k}\Omega$ to 1.1 k Ω	200		1500	mA	
V_{IN-DPM}	Input voltage threshold when input current is reduced	EN2 = LO, EN1 = X	4.35	4.5	4.63	V	
V_{DPPM}	Output voltage threshold when charging current is reduced		('72, '73, '74)	$V_{O(REG)} - 180\text{mV}$	$V_{O(REG)} - 100\text{mV}$	$V_{O(REG)} - 30\text{mV}$	V
			('75, '79)	4.2	4.3	4.4	V
V_{BSUP1}	Enter battery supplement mode	$V_{BAT} = 3.6\text{ V}$, $R_{ILIM} = 1.5\text{ k}\Omega$, $R_{LOAD} = 10\Omega \rightarrow 2\Omega$		$V_{OUT} \leq V_{BAT} - 40\text{mV}$		V	
V_{BSUP2}	Exit battery supplement mode	$V_{BAT} = 3.6\text{ V}$, $R_{ILIM} = 1.5\text{ k}\Omega$, $R_{LOAD} = 2\Omega \rightarrow 10\Omega$		$V_{OUT} \geq V_{BAT} - 20\text{mV}$		V	
$V_{O(SC1)}$	Output short-circuit detection threshold, power-on	$V_{IN} > V_{UVLO}$ and $V_{IN} > V_{BAT} + V_{IN(DT)}$	0.8	0.9	1	V	
$V_{O(SC2)}$	Output short-circuit detection threshold, supplement mode $V_{BAT} - V_{OUT} > V_{O(SC2)}$ indicates short-circuit	$V_{IN} > V_{UVLO}$ and $V_{IN} > V_{BAT} + V_{IN(DT)}$	200	250	300	mV	
$t_{DGL(SC2)}$	Deglintch time, supplement mode short circuit			250		μs	
$t_{REC(SC2)}$	Recovery time, supplement mode short circuit			60		ms	

ELECTRICAL CHARACTERISTICS (continued)

 Over junction temperature range ($0^{\circ} \leq T_J \leq 125^{\circ}\text{C}$) and the recommended supply voltage range (unless otherwise noted)

PARAMETER		TEST CONDITIONS	MIN	TYP	MAX	UNIT
BATTERY CHARGER						
I_{BAT}	Source current for BAT pin short-circuit detection	$V_{BAT} = 1.5\text{V}$	4	7.5	11	mA
$V_{BAT(SC)}$	BAT pin short-circuit detection threshold	V_{BAT} rising	1.6	1.8	2	V
$V_{BAT(REG)}$	Battery charge voltage	(72, 73, 74, 75)	4.16	4.20	4.23	V
		(79)	4.059	4.100	4.141	
V_{LOWV}	Pre-charge to fast-charge transition threshold	$V_{IN} > V_{UVLO}$ and $V_{IN} > V_{BAT} + V_{IN(DT)}$	2.9	3	3.1	V
$t_{DGL1(LOWV)}$	Deglitch time on pre-charge to fast-charge transition			25		ms
$t_{DGL2(LOWV)}$	Deglitch time on fast-charge to pre-charge transition			25		ms
I_{CHG}	Battery fast charge current range	$V_{BAT(REG)} > V_{BAT} > V_{LOWV}$, $V_{IN} = 5\text{V}$ $\overline{CE} = \text{LO}$, $\text{EN1} = \text{LO}$, $\text{EN2} = \text{HI}$	150		1500	mA
	Battery fast charge current	$\overline{CE} = \text{LO}$, $\text{EN1} = \text{LO}$, $\text{EN2} = \text{HI}$, $V_{BAT} > V_{LOWV}$, $V_{IN} = 5\text{V}$, $I_{INmax} > I_{CHG}$, no load on OUT pin, thermal loop and DPPM loop not active		K_{ISET}/R_{ISET}		A
K_{ISET}	Fast charge current factor		797	890	975	A Ω
I_{PRECHG}	Pre-charge current			K_{PRECHG}/R_{ISET}		A
K_{PRECHG}	Pre-charge current factor		70	88	106	A Ω
I_{TERM}	Termination comparator detection threshold (internally set)	$\overline{CE} = \text{LO}$, (EN1 , EN2) \neq (LO , LO), $V_{BAT} > V_{RCH}$, $t < t_{MAXCH}$, $V_{IN} = 5\text{V}$, DPPM loop and thermal loop not active	$0.09 \times I_{CHG}$	$0.1 \times I_{CHG}$	$0.11 \times I_{CHG}$	A
		$\overline{CE} = \text{LO}$, (EN1 , EN2) = (LO , LO), $V_{BAT} > V_{RCH}$, $t < t_{MAXCH}$, $V_{IN} = 5\text{V}$, DPPM loop and thermal loop not active	$0.027 \times I_{CHG}$	$0.033 \times I_{CHG}$	$0.040 \times I_{CHG}$	
$I_{BIAS(TERM)}$	Current for external termination-setting resistor	$V_{IN} > V_{UVLO}$ and $V_{IN} > V_{BAT} + V_{IN(DT)}$	72	75	78	μA
I_{TERM}	Termination current threshold (externally set) (bq24074)			$K_{ITERM} \times R_{ITERM} / R_{ISET}$		A
K_{ITERM}	K Factor for termination detection threshold (externally set) (bq24074)	USB500 or ISET mode (EN1 , EN2) \neq (LO , LO) $\overline{CE} = \text{LO}$, $V_{BAT} > V_{RCH}$, $t < t_{MAXCH}$, $V_{IN} = 5\text{V}$, DPPM loop and thermal loop not active	0.0225	0.0300	0.0375	A
		USB100 mode (EN1 , EN2) = (LO , LO), $\overline{CE} = \text{LO}$, $V_{BAT} > V_{RCH}$, $t < t_{MAXCH}$, $V_{IN} = 5\text{V}$, DPPM loop and thermal loop not active	0.008	0.0100	0.012	
$t_{DGL(TERM)}$	Deglitch time, termination detected			25		ms
V_{RCH}	Recharge detection threshold	$V_{IN} > V_{UVLO}$ and $V_{IN} > V_{BAT} + V_{IN(DT)}$	$V_{BAT(REG)} - 140\text{mV}$	$V_{BAT(REG)} - 100\text{mV}$	$V_{BAT(REG)} - 60\text{mV}$	V
$t_{DGL(RCH)}$	Deglitch time, recharge threshold detected			62.5		ms
$t_{DGL(NO-IN)}$	Delay time, input power loss to OUT LDO turn-off	$V_{BAT} = 3.6\text{V}$. Time measured from V_{IN} : $5\text{V} \rightarrow 3\text{V}$ 1 μs fall-time		20		ms
$I_{BAT(DET)}$	Sink current for battery detection	$V_{BAT} = 2.5\text{V}$	5	7.5	10	mA
t_{DET}	Battery detection timer	BAT high or low		250		ms
BATTERY CHARGING TIMERS						
t_{PRECHG}	Pre-charge safety timer value	TMR = floating	1440	1800	2160	s
t_{MAXCHG}	Charge safety timer value	TMR = floating	14400	18000	21600	s
t_{PRECHG}	Pre-charge safety timer value	$18\text{ k}\Omega < R_{TMR} < 72\text{ k}\Omega$		$R_{TMR} \times K_{TMR}$		s
t_{MAXCHG}	Charge safety timer value	$18\text{ k}\Omega < R_{TMR} < 72\text{ k}\Omega$		$10 \times R_{TMR} \times K_{TMR}$		s
K_{TMR}	Timer factor		36	48	60	s/k Ω
BATTERY-PACK NTC MONITOR⁽¹⁾						
I_{NTC}	NTC bias current	$V_{IN} > UVLO$ and $V_{IN} > V_{BAT} + V_{IN(DT)}$	72	75	78	μA
V_{HOT}	High temperature trip point	Battery charging, V_{TS} Falling	270	300	330	mV
$V_{HYS(HOT)}$	Hysteresis on high trip point	Battery charging, V_{TS} Rising from V_{HOT}		30		mV
V_{COLD}	Low temperature trip point	Battery charging, V_{TS} Rising	2000	2100	2200	mV
$V_{HYS(COLD)}$	Hysteresis on low trip point	Battery charging, V_{TS} Falling from V_{COLD}		300		mV
$t_{DGL(TS)}$	Deglitch time, pack temperature fault detection	TS fault detected to charger disable		50		ms
$V_{DIS(TS)}$	TS function disable threshold (bq24072, bq24073)	TS unconnected		$V_{IN} - 200\text{mV}$		V
THERMAL REGULATION						
$T_{J(REG)}$	Temperature regulation limit			125		$^{\circ}\text{C}$
$T_{J(OFF)}$	Thermal shutdown temperature	T_J Rising		155		$^{\circ}\text{C}$
$T_{J(OFF-HYS)}$	Thermal shutdown hysteresis			20		$^{\circ}\text{C}$

(1) These numbers set trip points of 0°C and 50°C while charging, with 3°C hysteresis on the trip points, with a Vishay Type 2 curve NTC with an R25 of 10 k Ω .

ELECTRICAL CHARACTERISTICS (continued)

Over junction temperature range ($0^{\circ} \leq T_j \leq 125^{\circ}\text{C}$) and the recommended supply voltage range (unless otherwise noted)

PARAMETER		TEST CONDITIONS	MIN	TYP	MAX	UNIT
LOGIC LEVELS ON EN1, EN2, $\overline{\text{CE}}$, SYSOFF, TD						
V_{IL}	Logic LOW input voltage		0		0.4	V
V_{IH}	Logic HIGH input voltage		1.4		6	V
I_{IL}	Input sink current	$V_{IL} = 0\text{V}$			1	μA
I_{IH}	Input source current	$V_{IH} = 1.4\text{V}$			10	μA
LOGIC LEVELS ON PGOOD, $\overline{\text{CHG}}$						
V_{OL}	Output LOW voltage	$I_{\text{SINK}} = 5\text{mA}$			0.4	V

**RGT PACKAGE
(Top View)**

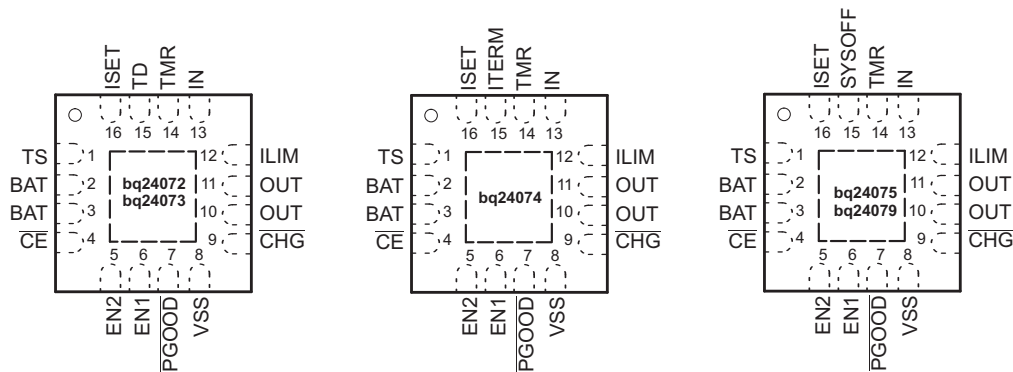

PIN FUNCTIONS

NAME	PIN NO.			I/O	DESCRIPTION
	'72, '73	'74	'75, '79		
TS	1	1	1	I	External NTC Thermistor Input. Connect the TS input to the NTC thermistor in the battery pack. TS monitors a 10k Ω NTC thermistor. For applications that do not utilize the TS function, connect a 10k Ω fixed resistor from TS to VSS to maintain a valid voltage level on TS.
BAT	2, 3	2, 3	2, 3	I/O	Charger Power Stage Output and Battery Voltage Sense Input. Connect BAT to the positive terminal of the battery. Bypass BAT to VSS with a 4.7 μF to 47 μF ceramic capacitor.
$\overline{\text{CE}}$	4	4	4	I	Charge Enable Active-Low Input. Connect $\overline{\text{CE}}$ to a high logic level to place the battery charger in standby mode. In standby mode, OUT is active and battery supplement mode is still available. Connect $\overline{\text{CE}}$ to a low logic level to enable the battery charger. $\overline{\text{CE}}$ is internally pulled down with $\sim 285\text{k}\Omega$. Do not leave $\overline{\text{CE}}$ unconnected to ensure proper operation.
EN2	5	5	5	I	Input Current Limit Configuration Inputs. Use EN1 and EN2 control the maximum input current and enable USB compliance. See Table 2 for the description of the operation states. EN1 and EN2 are internally pulled down with $\sim 285\text{k}\Omega$. Do not leave EN1 or EN2 unconnected to ensure proper operation.
EN1	6	6	6	I	
$\overline{\text{PGOOD}}$	7	7	7	O	Open-drain Power Good Status Indication Output. $\overline{\text{PGOOD}}$ pulls to VSS when a valid input source is detected. $\overline{\text{PGOOD}}$ is high-impedance when the input power is not within specified limits. Connect $\overline{\text{PGOOD}}$ to the desired logic voltage rail using a 1k Ω -100k Ω resistor, or use with an LED for visual indication.
VSS	8	8	8	–	Ground. Connect to the thermal pad and to the ground rail of the circuit.
$\overline{\text{CHG}}$	9	9	9	O	Open-Drain Charging Status Indication Output. $\overline{\text{CHG}}$ pulls to VSS when the battery is charging. $\overline{\text{CHG}}$ is high impedance when charging is complete and when charger is disabled. Connect $\overline{\text{CHG}}$ to the desired logic voltage rail using a 1k Ω -100k Ω resistor, or use with an LED for visual indication.
OUT	10, 11	10, 11	10, 11	O	System Supply Output. OUT provides a regulated output when the input is below the OVP threshold and above the regulation voltage. When the input is out of the operation range, OUT is connected to V_{BAT} except when SYSOFF is high (bq24075 and bq24079 only). Connect OUT to the system load. Bypass OUT to VSS with a 4.7 μF to 47 μF ceramic capacitor.
ILIM	12	12	12	I	Adjustable Current Limit Programming Input. Connect a 1100 Ω to 8 k Ω resistor from ILIM to VSS to program the maximum input current (EN2=1, EN1=0). The input current includes the system load and the battery charge current. Leaving ILIM unconnected disables all charging.
IN	13	13	13	I	Input Power Connection. Connect IN to the external DC supply (AC adapter or USB port). The input operating range is 4.35V to 6.6V (bq24072, bq24073, bq24075, and bq24079) or 4.35V to 10.5V (bq23074). The input can accept voltages up to 26V without damage but operation is suspended. Connect bypass capacitor 1 μF to 10 μF to VSS.

PIN FUNCTIONS (continued)

NAME	PIN			I/O	DESCRIPTION
	NO.				
	'72, '73	'74	'75, '79		
TMR	14	14	14	I	Timer Programming Input. TMR controls the pre-charge and fast-charge safety timers. Connect TMR to VSS to disable all safety timers. Connect a 18 kΩ to 72 kΩ resistor between TMR and VSS to program the timers a desired length. Leave TMR unconnected to set the timers to the default values.
TD	15	–	–	I	Termination Disable Input. Connect TD high to disable charger termination. Connect TD to VSS to enable charger termination. TD is checked during startup only and cannot be changed during operation. See the TD section in this datasheet for a description of the behavior when termination is disabled. TD is internally pulled down to VSS with ~285 kΩ. Do not leave TD unconnected to ensure proper operation.
ITERM	–	15	–	I	Termination Current Programming Input. Connect a 0 Ω to 15 kΩ resistor from ITERM to VSS to program the termination current. Leave ITERM unconnected to set the termination current to the default 10% termination threshold.
SYSOFF	–	–	15	I	System Enable Input. Connect SYSOFF high to turn off the FET connecting the battery to the system output. When an adapter is connected, charging is also disabled. Connect SYSOFF low for normal operation. SYSOFF is internally pulled up to V _{BAT} through a large resistor (~5 MΩ). Do not leave SYSOFF unconnected to ensure proper operation.
ISET	16	16	16	I/O	Fast Charge Current Programming Input. Connect a 590 Ω to 5.9 kΩ resistor from ISET to VSS to program the fast charge current level. Charging is disabled if ISET is left unconnected. While charging, the voltage at ISET reflects the actual charging current and can be used to monitor charge current. See the CHARGE CURRENT TRANSLATOR section for more details.
Thermal Pad				–	There is an internal electrical connection between the exposed thermal pad and the VSS pin of the device. The thermal pad must be connected to the same potential as the VSS pin on the printed circuit board. Do not use the thermal pad as the primary ground input for the device. VSS pin must be connected to ground at all times.

Table 1. EN1/EN2 Settings

EN2	EN1	Maximum input current into IN pin
0	0	100 mA. USB100 mode
0	1	500 mA. USB500 mode
1	0	Set by an external resistor from ILIM to VSS
1	1	Standby (USB suspend mode)

SIMPLIFIED BLOCK DIAGRAM

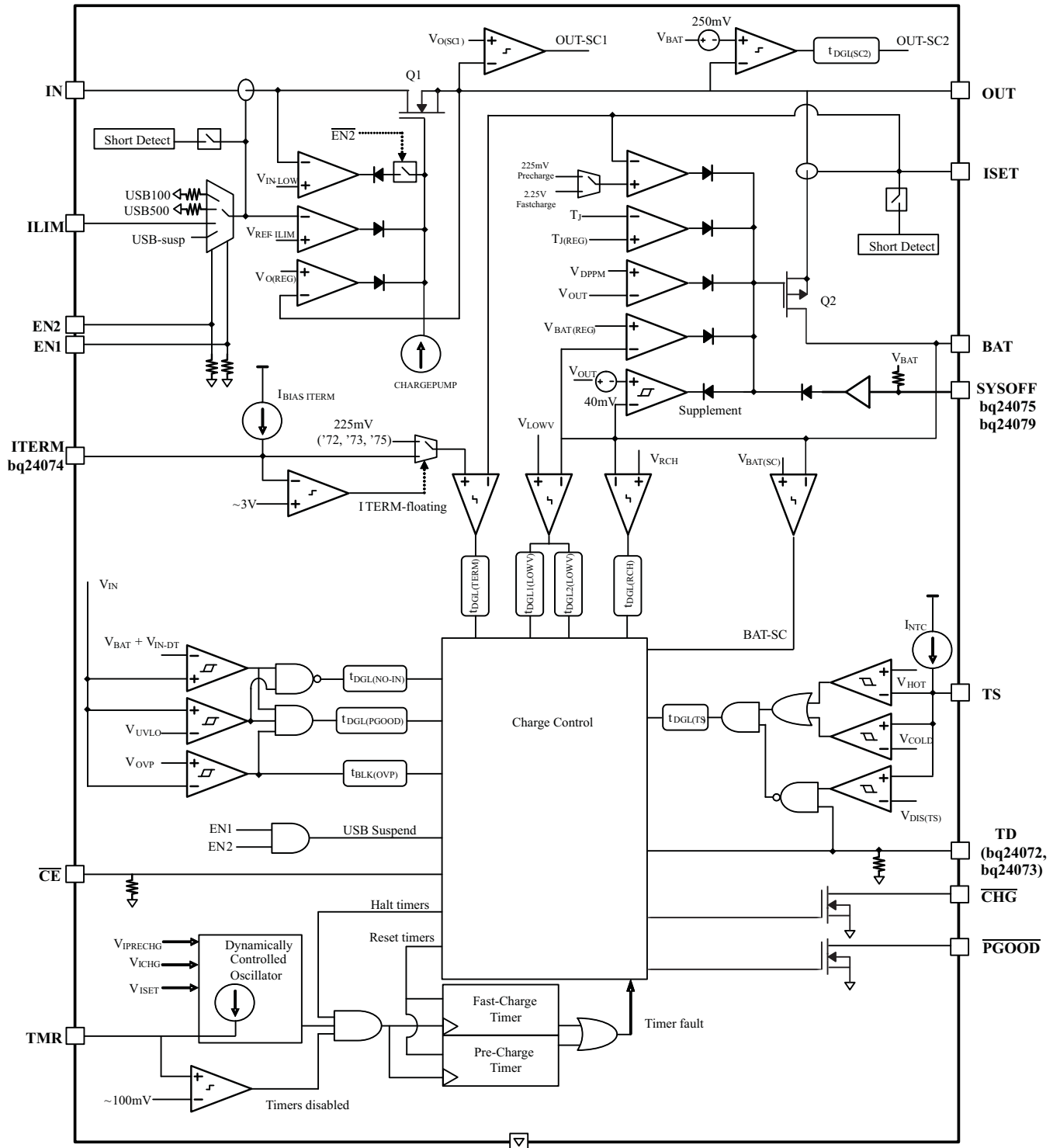

TYPICAL CHARACTERISTICS

$V_{IN} = 6V$, $EN1=1$, $EN2=0$, bq24073 application circuit, $T_A = 25^\circ C$, unless otherwise noted.

**ADAPTER PLUG-IN
BATTERY CONNECTED
 $R_{LOAD} = 10\Omega$**

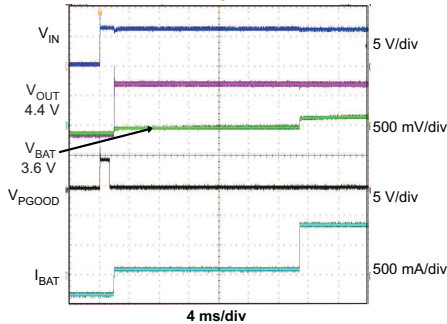

Figure 1.

**BATTERY DETECTION
BATTERY INSERTED**

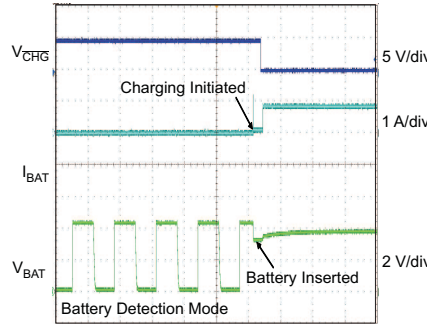

Figure 2.

**BATTERY DETECTION
BATTERY REMOVED**

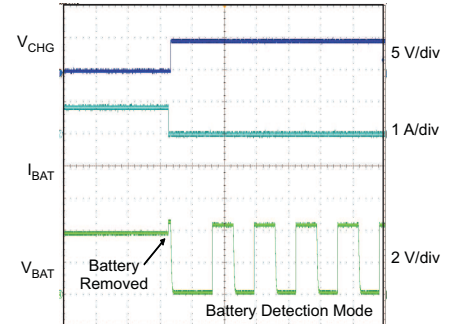

Figure 3.

**ENTERING AND EXITING DPPM
MODE
 $R_{LOAD} = 20\Omega$ to 9Ω**

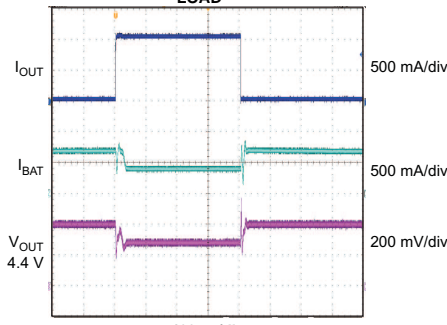

Figure 4.

**ENTERING AND EXITING BATTERY
SUPPLEMENT MODE
 $R_{LOAD} = 25\Omega$ to 4.5Ω
bq24074**

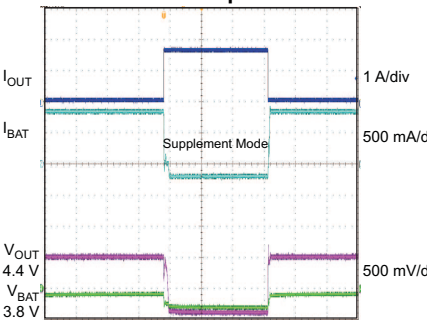

Figure 5.

**ENTERING AND EXITING BATTERY
SUPPLEMENT MODE
 $R_{LOAD} = 20\Omega$ to 4.5Ω
bq24072**

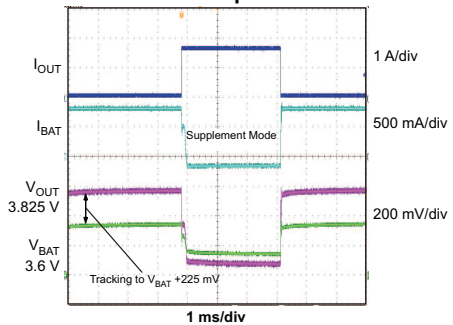

Figure 6.

CHARGER ON/OFF USING \overline{CE}

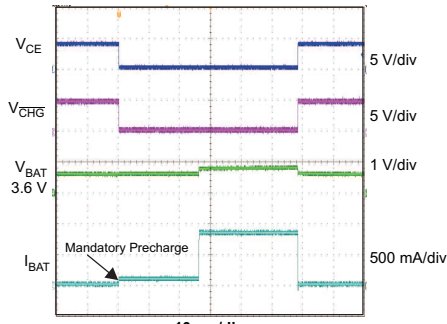

Figure 7.

**OVP FAULT
 $V_{IN} = 6V$ to $15V$
 $R_{LOAD} = 10\Omega$**

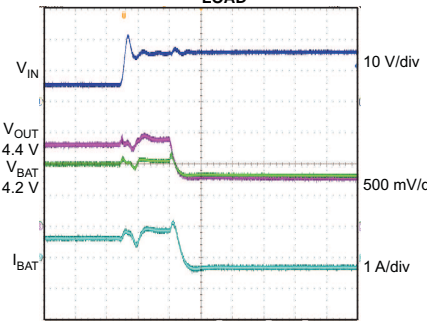

Figure 8.

**SYSTEM ON/OFF WITH INPUT
CONNECTED
 $V_{IN} = 6V$
bq24075, bq24079**

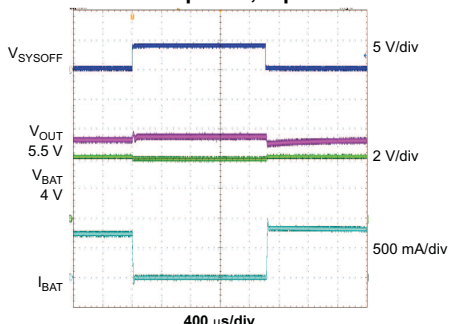

Figure 9.

TYPICAL CHARACTERISTICS (continued)

$V_{IN} = 6V$, $EN1=1$, $EN2=0$, bq24073 application circuit, $T_A = 25^\circ C$, unless otherwise noted.

SYSTEM ON/OFF WITH INPUT NOT CONNECTED

$V_{IN} = 0V$
bq24075, bq24079

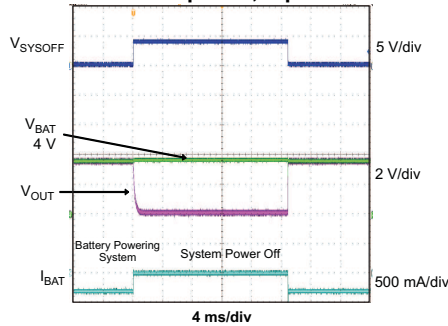

Figure 10.

THERMAL REGULATION

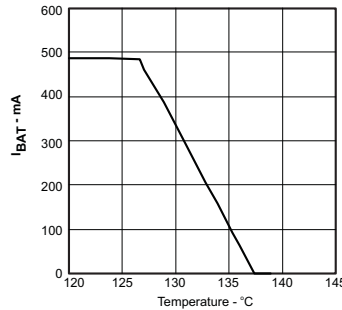

Figure 11.

DROPOUT VOLTAGE vs TEMPERATURE

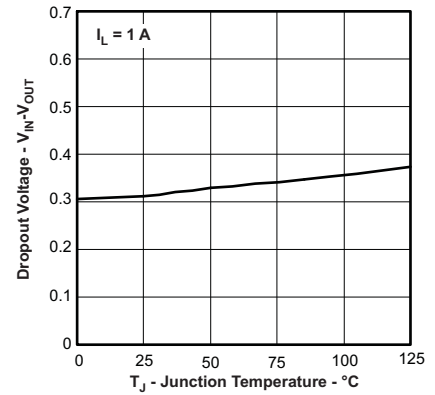

Figure 12.

DROPOUT VOLTAGE vs TEMPERATURE NO INPUT SUPPLY

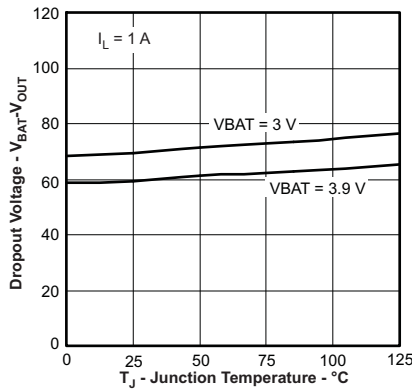

Figure 13.

bq24072 OUTPUT REGULATION VOLTAGE vs BATTERY VOLTAGE

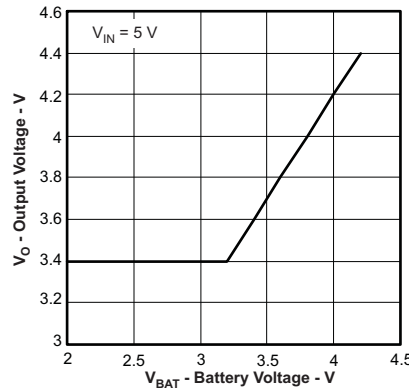

Figure 14.

bq24072 OUTPUT REGULATION VOLTAGE vs TEMPERATURE

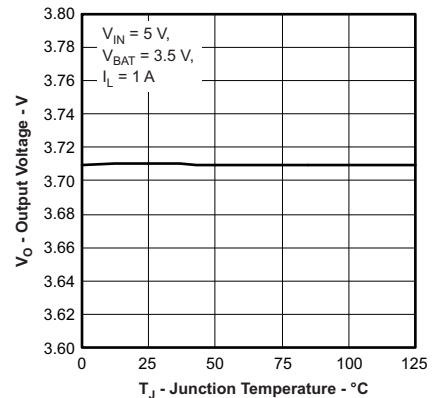

Figure 15.

bq24073/74 OUTPUT REGULATION VOLTAGE vs TEMPERATURE

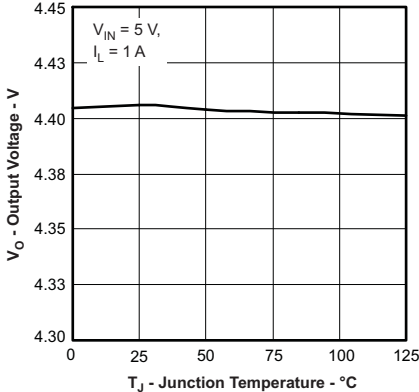

Figure 16.

bq24075, bq24079 OUTPUT REGULATION VOLTAGE vs TEMPERATURE

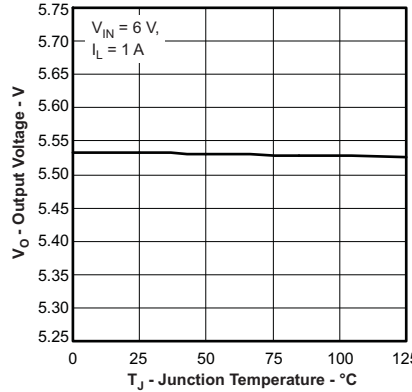

Figure 17.

BAT REGULATION VOLTAGE vs TEMPERATURE

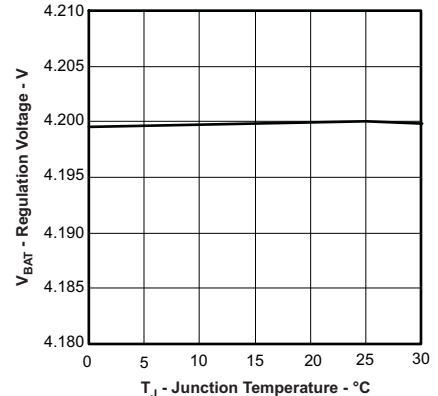

Figure 18.

TYPICAL CHARACTERISTICS (continued)

$V_{IN} = 6V$, $EN1=1$, $EN2=0$, bq24073 application circuit, $T_A = 25^\circ C$, unless otherwise noted.

bq24072/ 73/ 75/ 79
OVERVOLTAGE PROTECTION THRESHOLD
VS
TEMPERATURE

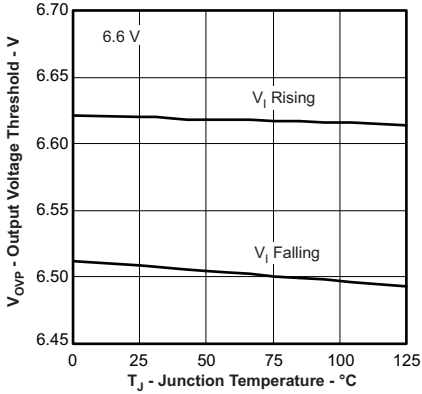

Figure 19.

bq24074
OVERVOLTAGE PROTECTION THRESHOLD
VS
TEMPERATURE

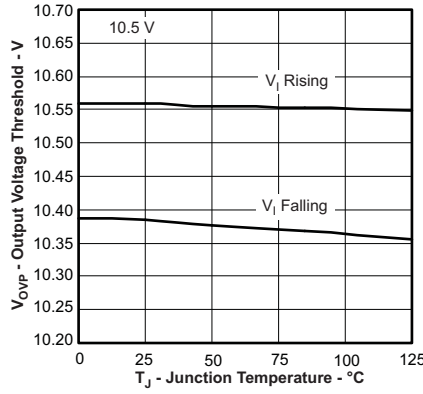

Figure 20.

bq24074
INPUT CURRENT LIMIT
VS
INPUT VOLTAGE

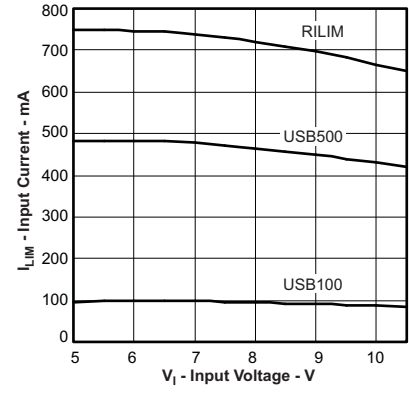

Figure 21.

FASTCHARGE CURRENT
VS
BATTERY VOLTAGE

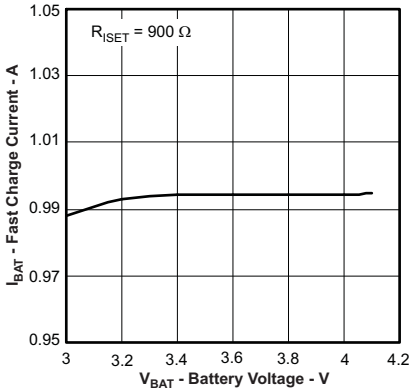

Figure 22.

FASTCHARGE CURRENT
VS
BATTERY VOLTAGE

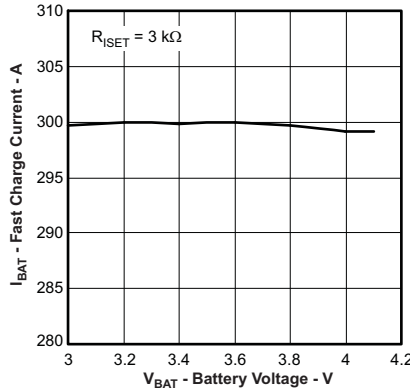

Figure 23.

PRECHARGE CURRENT
VS
BATTERY VOLTAGE

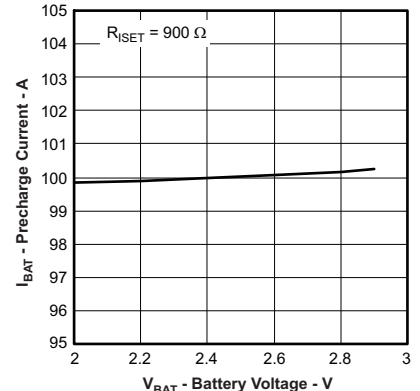

Figure 24.

PRECHARGE CURRENT
VS
BATTERY VOLTAGE

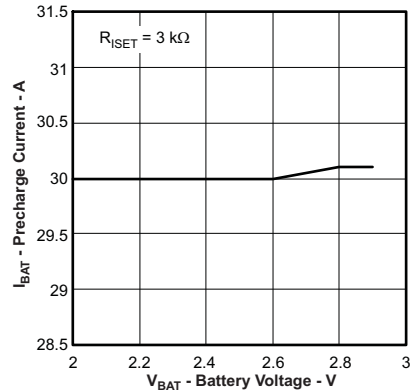

Figure 25.

APPLICATION CIRCUITS

V_{IN} = UVLO to V_{OVP} , $I_{FASTCHG}$ = 800mA, $I_{IN(MAX)}$ = 1.3A, Battery Temperature Charge Range = 0°C to 50°C, 6.25 hour Fastcharge Safety Timer

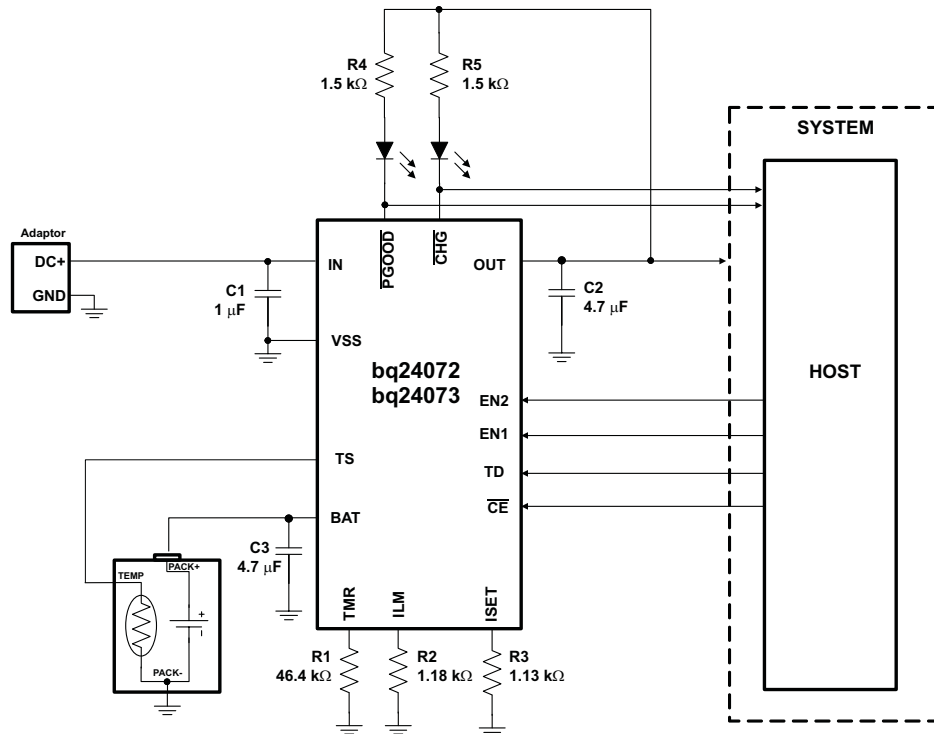

Figure 26. Using bq24072/ bq24073 in a Host Controlled Charger Application

$V_{IN} = UVLO$ to V_{OVP} , $I_{FASTCHG} = 800mA$, $I_{IN(MAX)} = 1.3A$, $I_{TERM} = 110mA$, Battery Temperature Charge Range = $0^{\circ}C$ to $50^{\circ}C$, Safety Timers disabled

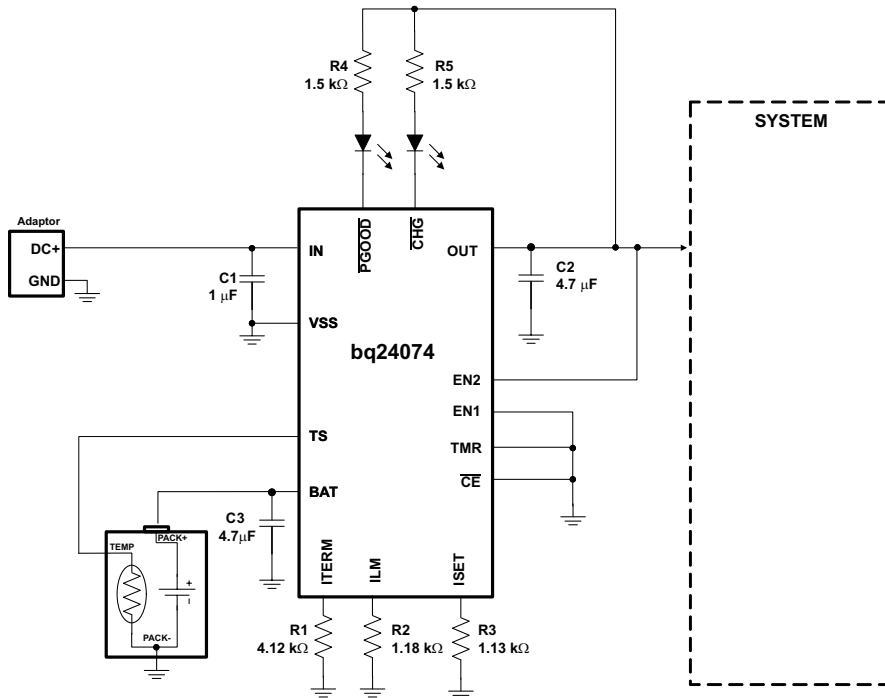

Figure 27. Using bq24074 in a Stand Alone Charger Application

$V_{IN} = UVLO$ to V_{OVP} , $I_{FASTCHG} = 800mA$, $I_{IN(MAX)} = 1.3A$, Battery Temperature Charge Range = $0^{\circ}C$ to $50^{\circ}C$, 6.25 hour Fastcharge Safety Timer

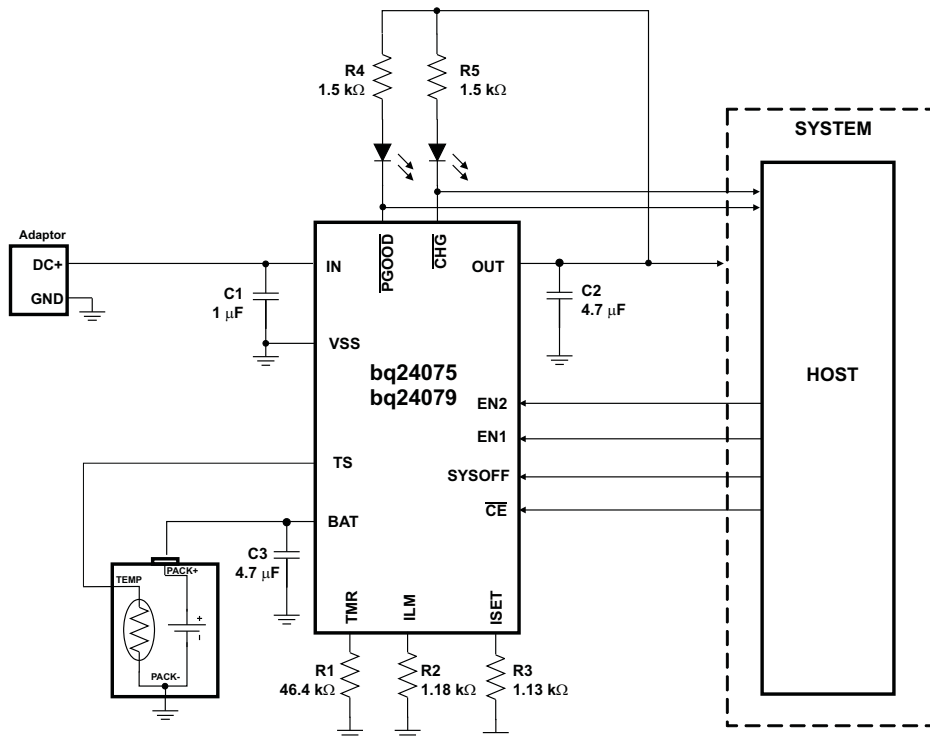

Figure 28. Using bq24075 or bq24079 to Disconnect the Battery from the System

EXPLANATION OF DEGLITCH TIMES AND COMPARATOR HYSTERESIS

Figures not to scale

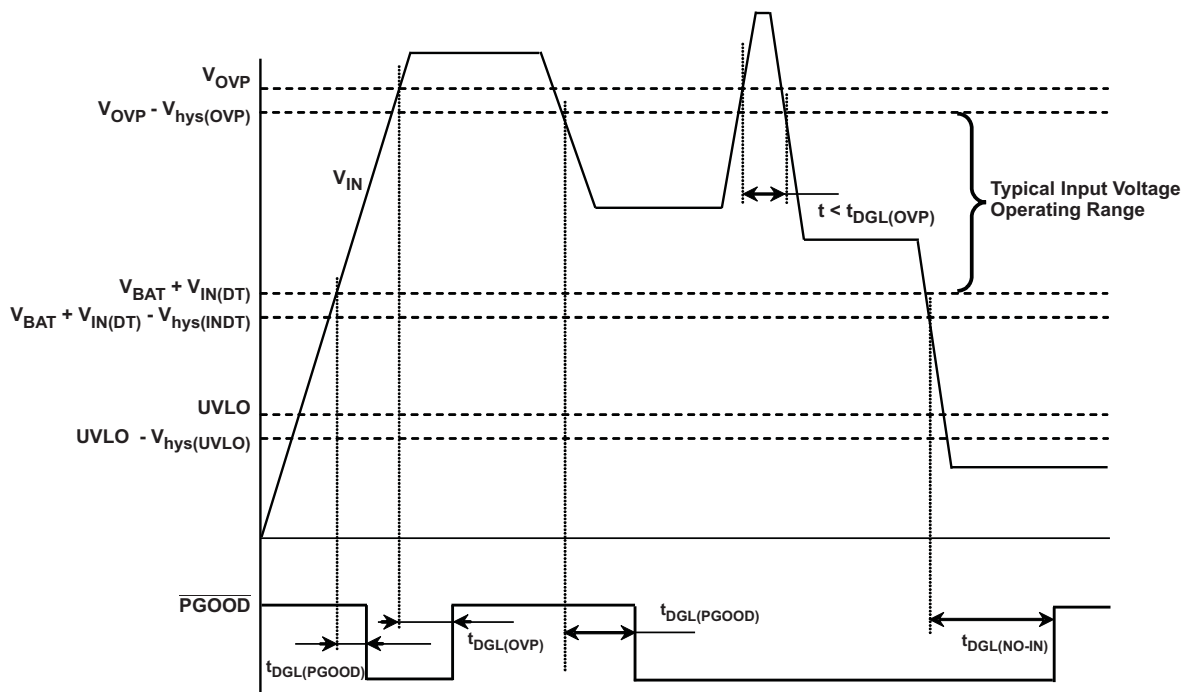

Figure 29. Power-Up, Power-Down, Power Good Indication

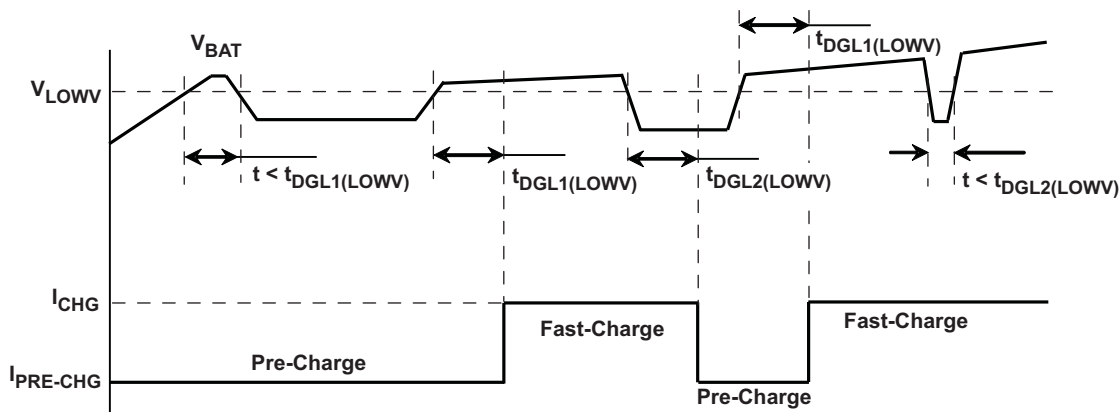

Figure 30. Pre- to Fast-Charge, Fast- to Pre-Charge Transition – $t_{DGL1(LOWV)}$, $t_{DGL2(LOWV)}$

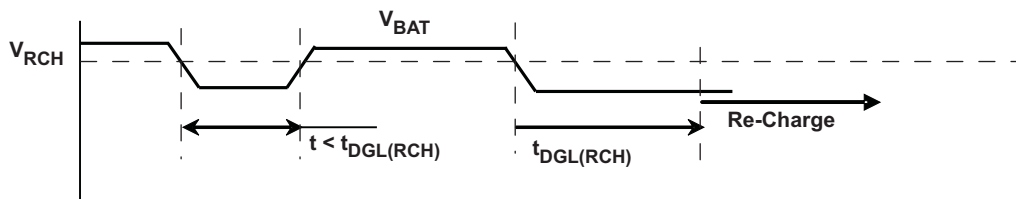

Figure 31. Recharge – $t_{DGL(RCH)}$

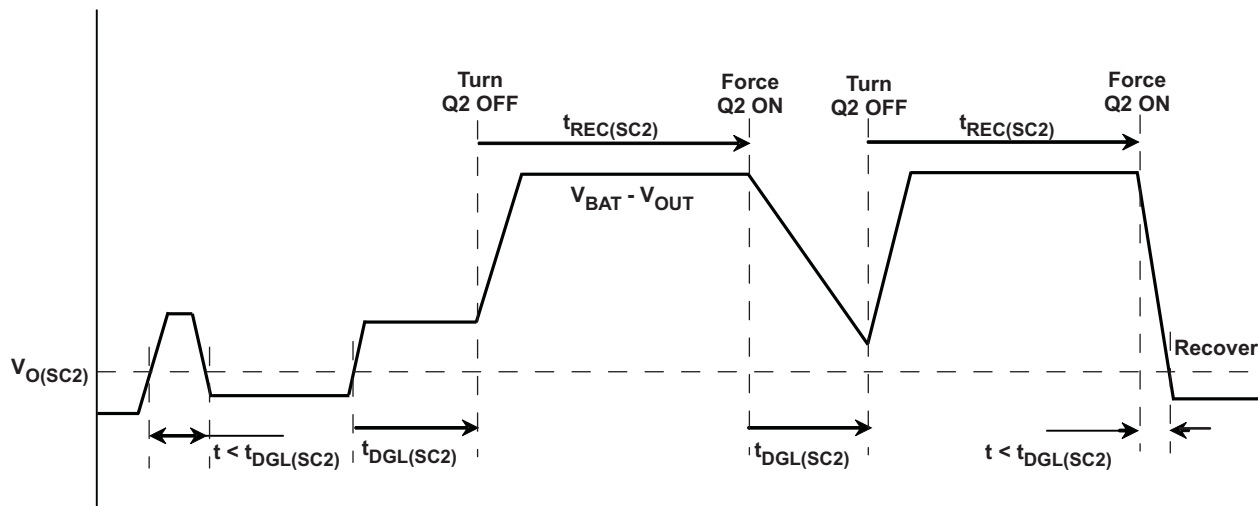

Figure 32. OUT Short-Circuit – Supplement Mode

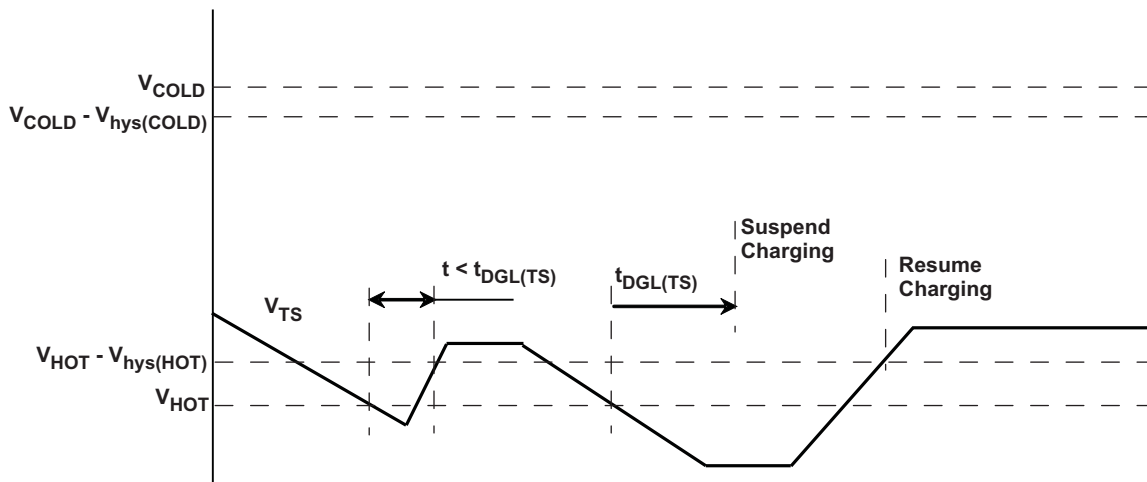

Figure 33. Battery Pack Temperature Sensing – TS Pin. Battery Temperature Increasing

DETAILED FUNCTIONAL DESCRIPTION

The bq2407x devices are integrated Li-Ion linear chargers and system power path management devices targeted at space-limited portable applications. The device powers the system while simultaneously and independently charging the battery. This feature reduces the number of charge and discharge cycles on the battery, allows for proper charge termination and enables the system to run with a defective or absent battery pack. It also allows instant system turn-on even with a totally discharged battery. The input power source for charging the battery and running the system can be an AC adapter or a USB port. The devices feature Dynamic Power Path Management (DPPM), which shares the source current between the system and battery charging, and automatically reduces the charging current if the system load increases. When charging from a USB port, the input dynamic power management (V_{IN} -DPM) circuit reduces the input current if the input voltage falls below a threshold, preventing the USB port from crashing. The power-path architecture also permits the battery to supplement the system current requirements when the adapter cannot deliver the peak system currents.

UNDERVOLTAGE LOCKOUT (UVLO)

The bq2407X family remains in power down mode when the input voltage at the IN pin is below the undervoltage threshold (UVLO).

During the power down mode the host commands at the control inputs (\overline{CE} , EN1 and EN2) are ignored. The Q1 FET connected between IN and OUT pins is off, and the status outputs \overline{CHG} and \overline{PGOOD} are high impedance. The Q2 FET that connects BAT to OUT is ON. (If SYSOFF is high, Q2 is off). During power down mode, the $V_{OUT(SC2)}$ circuitry is active and monitors for overload conditions on OUT.

POWER ON

When V_{IN} exceeds the UVLO threshold, the bq2407x powers up. While V_{IN} is below $V_{BAT} + V_{IN(DT)}$, the host commands at the control inputs (\overline{CE} , EN1 and EN2) are ignored. The Q1 FET connected between IN and OUT pins is off, and the status outputs \overline{CHG} and \overline{PGOOD} are high impedance. The Q2 FET that connects BAT to OUT is ON. (If SYSOFF is high, Q2 is off). During this mode, the $V_{OUT(SC2)}$ circuitry is active and monitors for overload conditions on OUT.

Once V_{IN} rises above $V_{BAT} + V_{IN(DT)}$, \overline{PGOOD} is driven low to indicate the valid power status and the \overline{CE} , EN1, and EN2 inputs are read. The device enters standby mode if (EN1 = EN2 = HI) or if an input overvoltage condition occurs. In standby mode, Q1 is OFF and Q2 is ON so OUT is connected to the battery input. (If SYSOFF is high, FET Q2 is off). During this mode, the $V_{OUT(SC2)}$ circuitry is active and monitors for overload conditions on OUT.

When the input voltage at IN is within the valid range: $V_{IN} > UVLO$ **AND** $V_{IN} > V_{BAT} + V_{IN(DT)}$ **AND** $V_{IN} < V_{OVP}$, and the EN1 and EN2 pins indicate that the USB suspend mode is not enabled [(EN1, EN2) \neq (HI, HI)] all internal timers and other circuit blocks are activated. The device then checks for short-circuits at the ISET and ILIM pins. If no short conditions exists, the device switches on the input FET Q1 with a 100mA current limit to checks for a short circuit at OUT. When V_{OUT} is above V_{SC} , the FET Q1 switches to the current limit threshold set by EN1, EN2 and R_{ILIM} and the device enters into the normal operation. During normal operation, the system is powered by the input source (Q1 is regulating), and the device continuously monitors the status of \overline{CE} , EN1 and EN2 as well as the input voltage conditions.

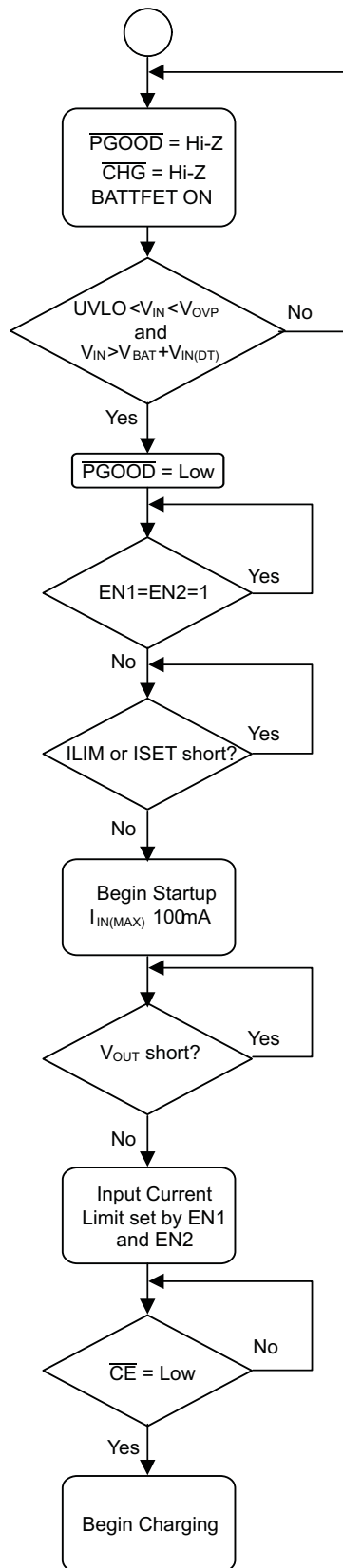

Figure 34. Startup Flow Diagram

OVERVOLTAGE PROTECTION (OVP)

The bq2407x accepts inputs up to 28V without damage. Additionally, an overvoltage protection (OVP) circuit is implemented that shuts off the internal LDO and discontinues charging when $V_{IN} > V_{OVP}$ for a period long than $t_{DGL(OVP)}$. When in OVP, the system output (OUT) is connected to the battery and PGOOD is high impedance. Once the OVP condition is removed, a new power on sequence starts (See the [POWER ON](#) section). The safety timers are reset and a new charge cycle will be indicated by the CHG output.

DYNAMIC POWER-PATH MANAGEMENT

The bq2407x features an OUT output that powers the external load connected to the battery. This output is active whenever a source is connected to IN or BAT. The following sections discuss the behavior of OUT with a source connected to IN to charge the battery and a battery source only.

INPUT SOURCE CONNECTED (ADAPTER or USB)

With a source connected, the dynamic power-path management (DPPM) circuitry of the bq2407x monitors the input current continuously. The OUT output for the bq24073/ 74/ 75/ 79 is regulated to a fixed voltage ($V_{O(REG)}$). For the bq24072, OUT is regulated to 200mV above the voltage at BAT. When the BAT voltage falls below 3.2V, OUT is clamped to 3.4V. This allows for proper startup of the system load even with a discharged battery. The current into IN is shared between charging the battery and powering the system load at OUT. The bq2407x has internal selectable current limits of 100mA (USB100) and 500mA (USB500) for charging from USB ports, as well as a resistor-programmable input current limit.

The bq2407x is USB IF compliant for the inrush current testing. The USB spec allows up to 10 μ F to be hard started, which establishes 50 μ C as the maximum inrush charge value when exceeding 100mA. The input current limit for the bq2407x prevents the input current from exceeding this limit, even with system capacitances greater than 10 μ F. Note that the input capacitance to the device must be selected small enough to prevent a violation (<10 μ F), as this current is not limited. [Figure 35](#) demonstrates the startup of the bq2407x and compares it to the USB-IF specification.

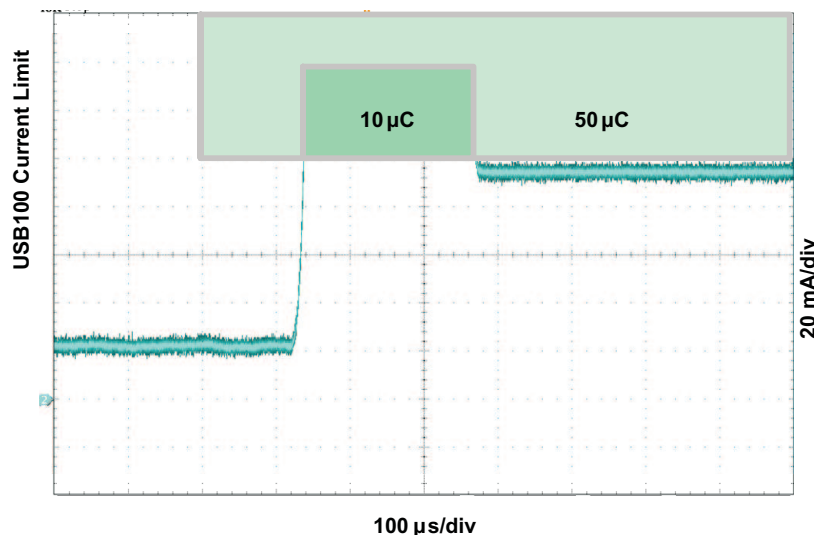

Figure 35. USB-IF Inrush Current Test

The input current limit selection is controlled by the state of the EN1 and EN2 pins as shown in [Table 1](#). When using the resistor-programmable current limit, the input current limit is set by the value of the resistor connected from the ILIM pin to VSS, and is given by the equation:

$$I_{IN-MAX} = K_{ILIM}/R_{ILIM} \quad (1)$$

The input current limit is adjustable up to 1.5A. The valid resistor range is 1.1 k Ω to 8 k Ω .

When the IN source is connected, priority is given to the system load. The DPPM and Battery Supplement modes are used to maintain the system load. [Figure 37](#) and [Figure 38](#) illustrate examples of the DPPM and supplement modes. These modes are explained in detail in the following sections.

Input DPM Mode (V_{IN-DPM})

The bq2407x utilizes the V_{IN-DPM} mode for operation from current-limited USB ports. When EN1 and EN2 are configured for USB100 (EN2=0, EN1=0) or USB500 (EN2=0, EN2=1) modes, the input voltage is monitored. If V_{IN} falls to V_{IN-DPM} , the input current limit is reduced to prevent the input voltage from falling further. This prevents the bq2407x from crashing poorly designed or incorrectly configured USB sources. Figure 36 shows the V_{IN-DPM} behavior to a current limited source. In this figure, the input source has a 400mA current limit and the device is in USB500 mode (EN1=1, EN2=0).

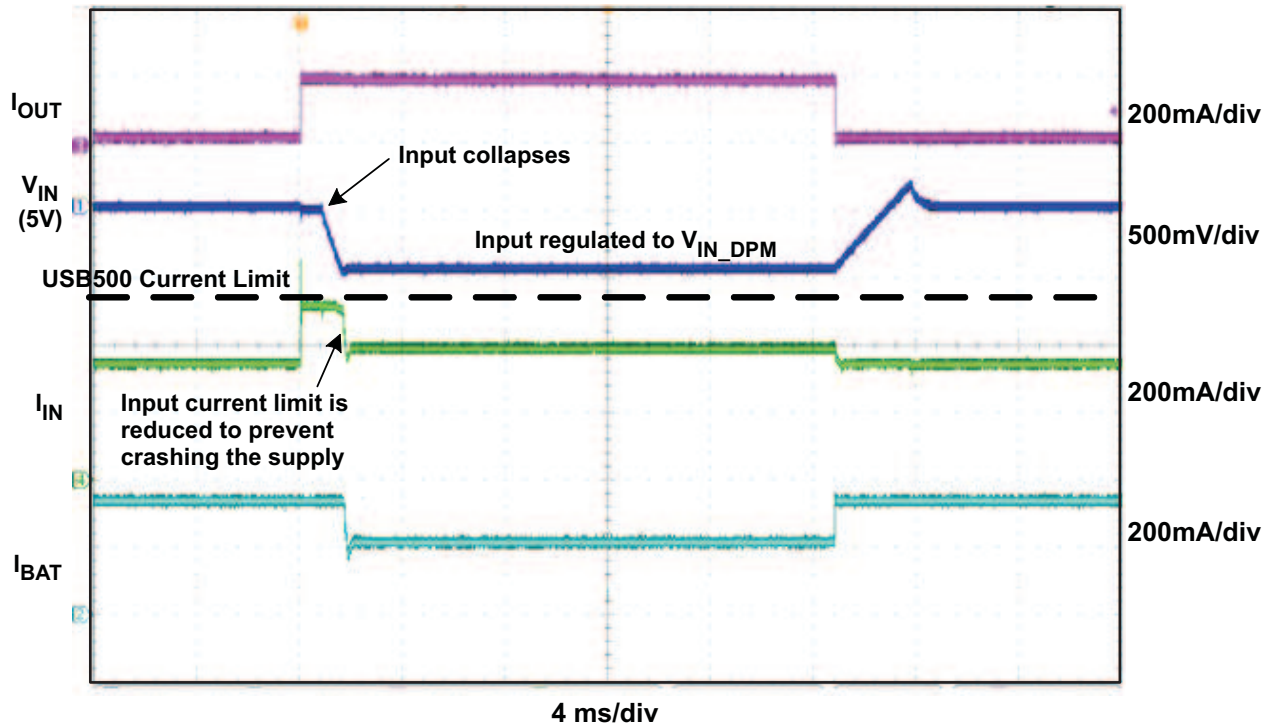

Figure 36. V_{IN-DPM} Waveform

DPPM Mode

When the sum of the charging and system load currents exceeds the maximum input current (programmed with EN1, EN2 and ILIM pins), the voltage at OUT decreases. Once the voltage on the OUT pin falls to V_{DPPM} , the bq2407x enters DPPM mode. In this mode, the charging current is reduced as the OUT current increases in order to maintain the system output. Battery termination is disabled while in DPPM mode.

Battery Supplement Mode

While in DPPM mode, if the charging current falls to zero and the system load current increases beyond the programmed input current limit, the voltage at OUT reduces further. When the OUT voltage drops below the V_{BSUP1} threshold, the battery supplements the system load. The battery stops supplementing the system load when the voltage at OUT rises above the V_{BSUP2} threshold.

During supplement mode, the battery supplement current is not regulated (BAT-FET is fully on), however there is a short circuit protection circuit built in. Figure 5 demonstrates supplement mode. If during battery supplement mode, the voltage at OUT drops $V_{O(SC2)}$ below the BAT voltage, the OUT output is turned off if the overload exists after $t_{DGL(SC2)}$. The short circuit recovery timer then starts counting. After $t_{REC(SC2)}$, OUT turns on and attempts to restart. If the short circuit remains, OUT is turned off and the counter restarts. Battery termination is disabled while in supplement mode.

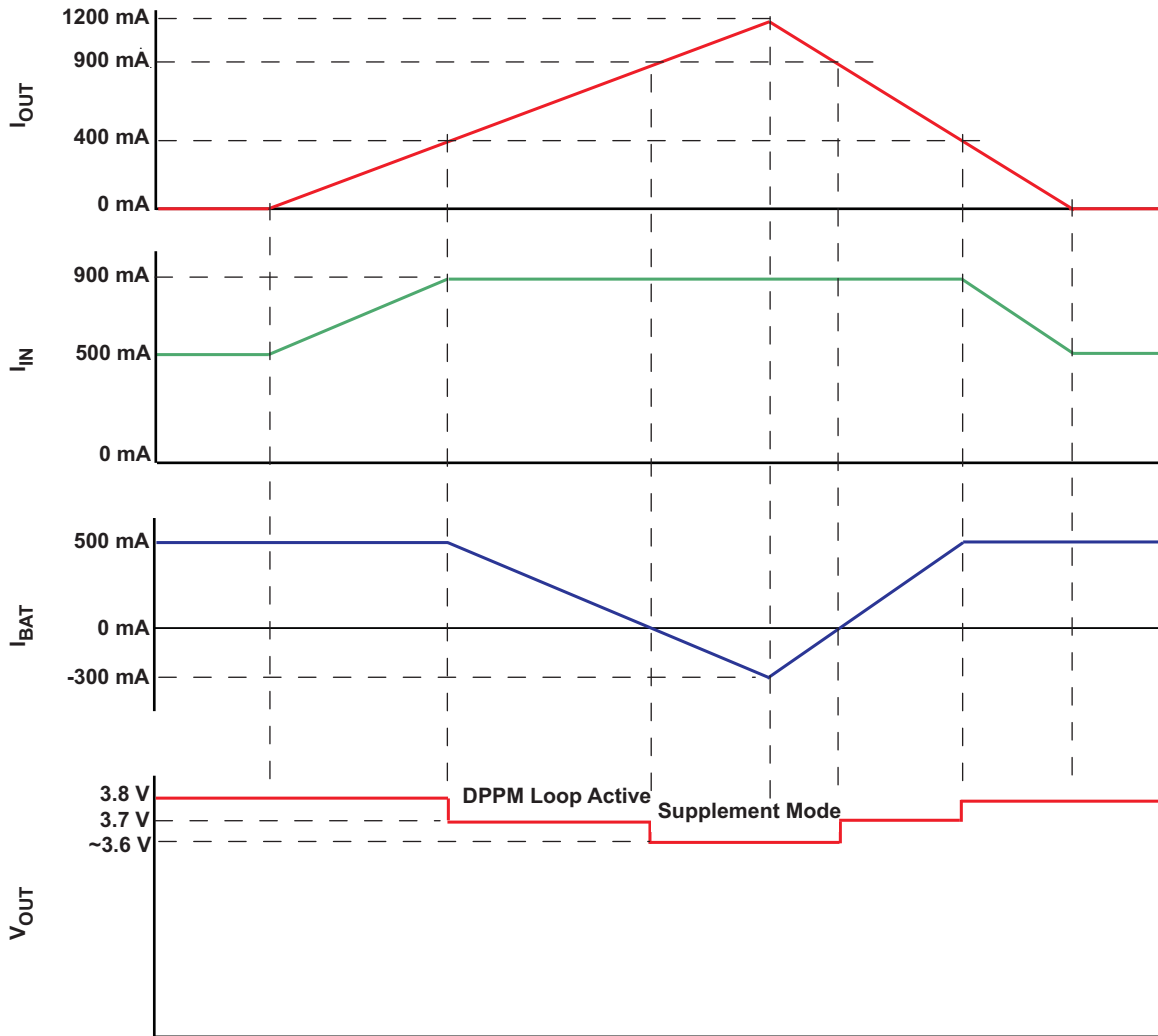

Figure 37. bq24072 DPPM and Battery Supplement Modes ($V_{OREG} = V_{BAT} + 225\text{mV}$, $V_{BAT} = 3.6\text{V}$)

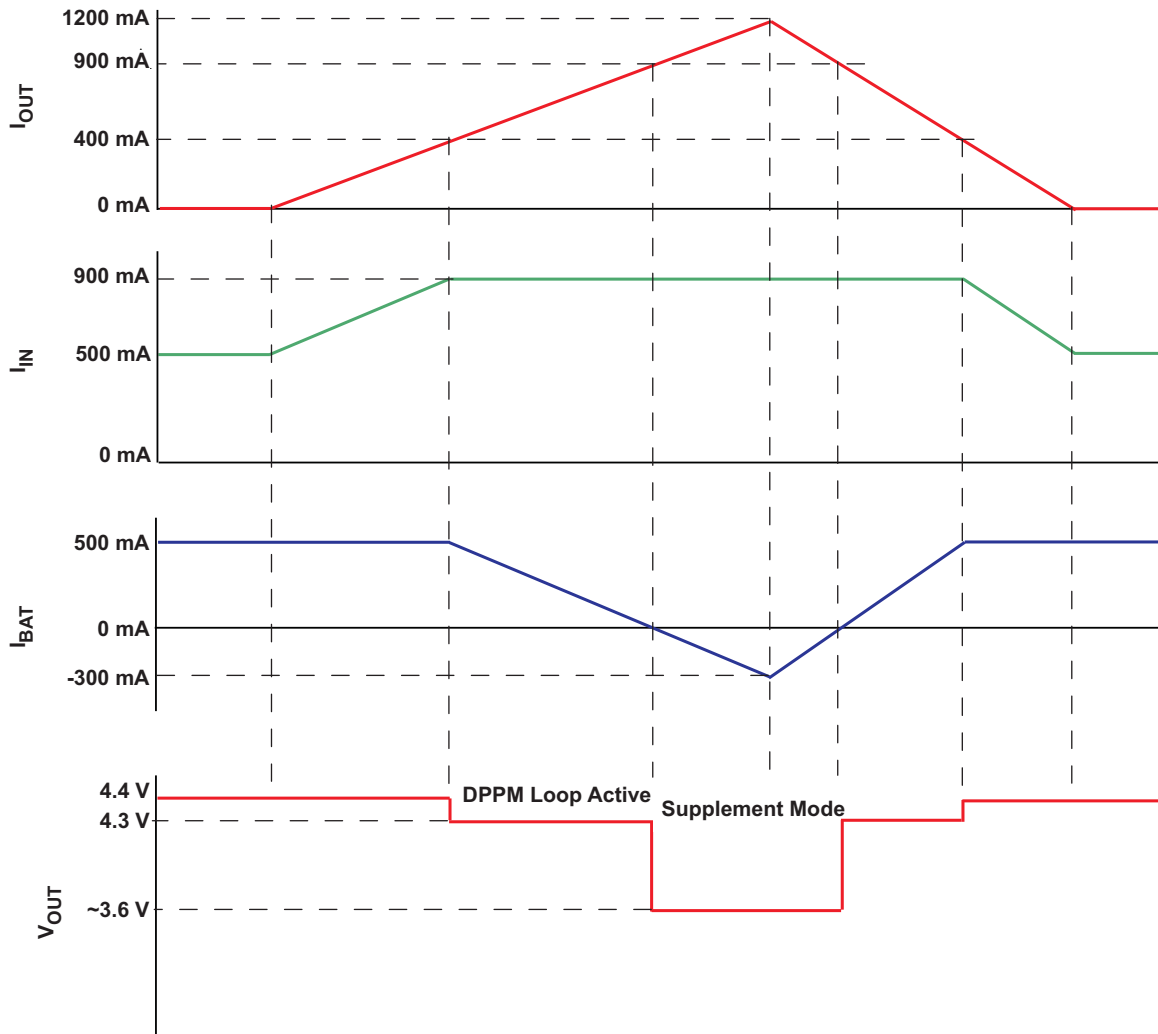

Figure 38. bq24073 DPPM and Battery Supplement Modes ($V_{OREG} = 4.4V$, $V_{BAT} = 3.6V$)

INPUT SOURCE NOT CONNECTED

When no source is connected to the IN input, OUT is powered strictly from the battery. During this mode the current into OUT is not regulated, similar to *Battery Supplement Mode*, however the short circuit circuitry is active. If the OUT voltage falls below the BAT voltage by 250mV for longer than $t_{DGL(SC2)}$, OUT is turned off. The short circuit recovery timer then starts counting. After $t_{REC(SC2)}$, OUT turns on and attempts to restart. If the short circuit remains, OUT is turned off and the counter restarts. This ON/OFF cycle continues until the overload condition is removed.

BATTERY CHARGING

Set \overline{CE} low to initiate battery charging. First, the device checks for a short-circuit on the BAT pin by sourcing $I_{BAT(SC)}$ to the battery and monitoring the voltage. When the BAT voltage exceeds $V_{BAT(SC)}$, the battery charging continues. The battery is charged in three phases: conditioning pre-charge, constant current fast charge (current regulation) and a constant voltage tapering (voltage regulation). In all charge phases, an internal control loop monitors the IC junction temperature and reduces the charge current if an internal temperature threshold is exceeded.

Figure 39 illustrates a normal Li-Ion charge cycle using the bq2407x:

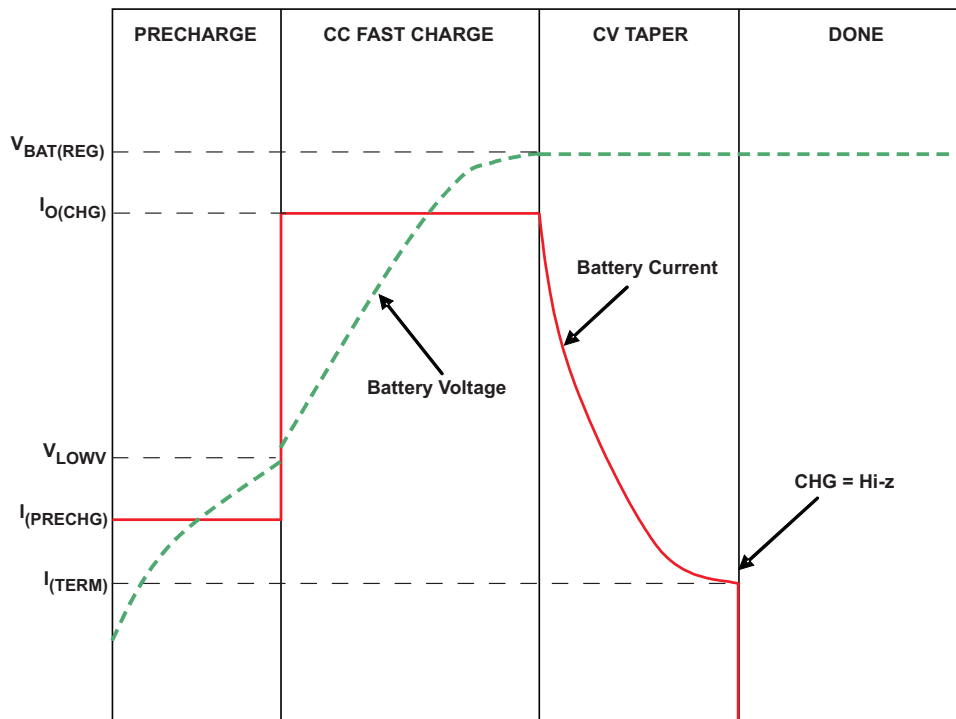

Figure 39. Typical Charge Cycle

In the pre-charge phase, the battery is charged at with the pre-charge current (I_{PRECHG}). Once the battery voltage crosses the V_{LOWV} threshold, the battery is charged with the fast-charge current (I_{CHG}). As the battery voltage reaches $V_{BAT(REG)}$, the battery is held at a constant voltage of $V_{BAT(REG)}$ and the charge current tapers off as the battery approaches full charge. When the battery current reaches I_{TERM} , the CHG pin indicates *charging done* by going high-impedance.

Note that termination detection is disabled whenever the charge rate is reduced because of the actions of the thermal loop, the DPPM loop or the $V_{IN(LOW)}$ loop.

The value of the fast-charge current is set by the resistor connected from the ISET pin to VSS, and is given by the equation

$$I_{CHG} = K_{ISET}/R_{ISET}$$

The charge current limit is adjustable up to 1.5A. The valid resistor range is 590 Ω to 5.9 k Ω . Note that if I_{CHG} is programmed as greater than the input current limit, the battery will not charge at the rate of I_{CHG} , but at the slower rate of $I_{IN(MAX)}$ (minus the load current on the OUT pin, if any). In this case, the charger timers will be proportionately slowed down.

CHARGE CURRENT TRANSLATOR

When the charger is enabled, internal circuits generate a current proportional to the charge current at the ISET input. The current out of ISET is 1/400 ($\pm 10\%$) of the charge current. This current, when applied to the external charge current programming resistor, R_{ISET} , generates an analog voltage that can be monitored by an external host to calculate the current sourced from BAT.

$$V_{ISET} = I_{CHARGE} / 400 \times R_{ISET} \quad (1)$$

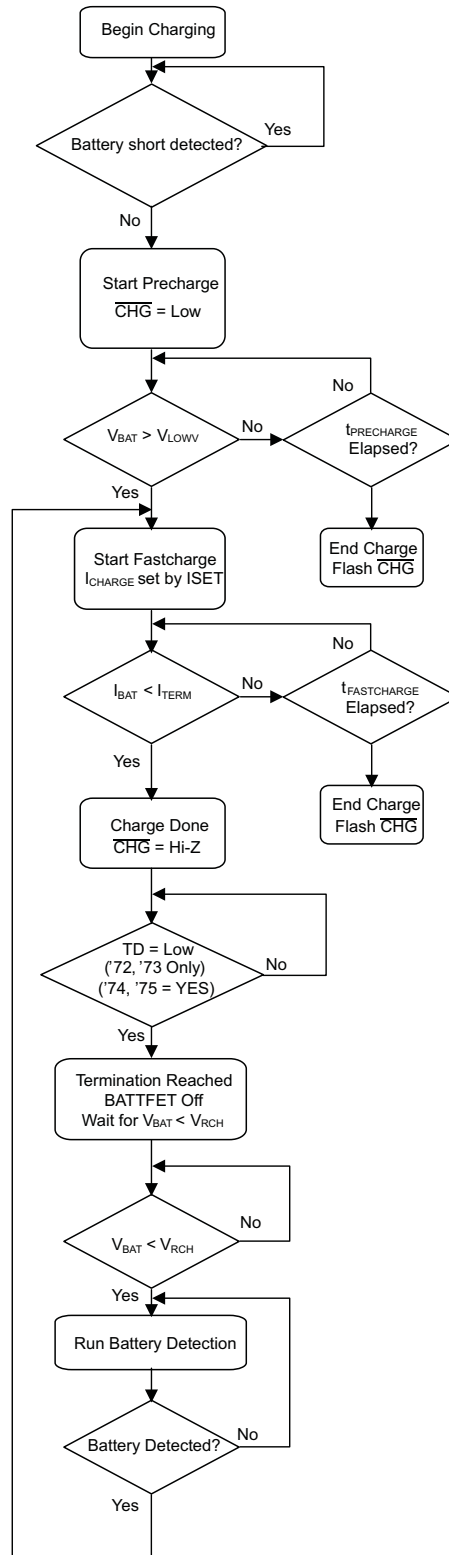

Figure 40. Battery Charging Flow Diagram

ADJUSTABLE TERMINATION THRESHOLD (ITERM Input, bq24074)

The termination current threshold in the bq24074 is user-programmable. Set the termination current by connecting a resistor from ITERM to VSS. For USB100 mode (EN1 = EN2 = Low), the termination current value is calculated as:

$$I_{\text{TERM}} = 0.01 \times R_{\text{ITERM}} / R_{\text{ISET}} \quad (1)$$

In the other input current limit modes (EN1 ≠ EN2), the termination current value is calculated as:

$$I_{\text{TERM}} = 0.03 \times R_{\text{ITERM}} / R_{\text{ISET}} \quad (1)$$

The termination current is programmable up to 50% of the fastcharge current. The R_{ITERM} resistor must be less than 15 kΩ. Leave ITERM unconnected to select the default internally set termination current.

TERMINATION DISABLE (TD Input, bq24072, bq24073)

The bq24072 and bq24073 contain a TD input that allows termination to be enabled/ disabled. Connect TD to a logic high to disable charge termination. When termination is disabled, the device goes through the pre-charge, fast-charge and CV phases, then remains in the CV phase. During the CV phase, the charger maintains the output voltage at BAT equal to V_{BAT(REG)}, and charging current does not terminate. The charge current is set by I_{CHG} or I_{INmax}, whichever is less. Battery detection is not performed. The $\overline{\text{CHG}}$ output is high impedance once the current falls below I_{TERM} and does not go low until the input power or $\overline{\text{CE}}$ are toggled. When termination is disabled, the pre-charge and fast-charge safety timers are also disabled. Battery pack temperature sensing (TS pin functionality) is disabled if the TD pin is high and the TS pin is unconnected or pulled up to V_{IN}.

BATTERY DETECTION AND RECHARGE

The bq2407x automatically detects if a battery is connected or removed. Once a charge cycle is complete, the battery voltage is monitored. When the battery voltage falls below V_{RCH}, the battery detection routine is run. During battery detection, current (I_{BAT(DET)}) is pulled from the battery for a duration t_{DET} to see if the voltage on BAT falls below V_{LOWV}. If not, charging begins. If it does, then it indicates that the battery is missing or the protector is open. Next, the precharge current is applied for t_{DET} to close the protector if possible. If V_{BAT} < V_{RCH}, then the protector closed and charging is initiated. If V_{BAT} > V_{RCH}, then the battery is determined to be missing and the detection routine continues.

BATTERY DISCONNECT (SYSOFF Input, bq24075, bq24079)

The bq24075 and bq24079 feature a SYSOFF input that allows the user to turn the FET Q2 off and disconnect the battery from the OUT pin. This is useful for disconnecting the system load from the battery, factory programming where the battery is not installed or for host side impedance track fuel gauging, such as bq27500, where the battery open circuit voltage level must be detected before the battery charges or discharges. The /CHG output remains low when SYSOFF is high. Connect SYSOFF to VSS, to turn Q2 on for normal operation. SYSOFF is internally pulled to VBAT through ~5 MΩ resistor.

DYNAMIC CHARGE TIMERS (TMR Input)

The bq2407x devices contain internal safety timers for the pre-charge and fast-charge phases to prevent potential damage to the battery and the system. The timers begin at the start of the respective charge cycles. The timer values are programmed by connecting a resistor from TMR to VSS. The resistor value is calculated using the following equation:

$$t_{\text{PRECHG}} = K_{\text{TMR}} \times R_{\text{TMR}}$$

$$t_{\text{MAXCHG}} = 10 \times K_{\text{TMR}} \times R_{\text{TMR}}$$

Leave TMR unconnected to select the internal default timers. Disable the timers by connecting TMR to VSS.

Note that timers are suspended when the device is in thermal shutdown, and the timers are slowed proportionally to the charge current when the device enters thermal regulation. For the bq24072 and bq24073, the timers are disabled when TD is connected to a high logic level.

During the fast charge phase, several events increase the timer durations.

1. The system load current activates the DPPM loop which reduces the available charging current
2. The input current is reduced because the input voltage has fallen to V_{IN(LOW)}
3. The device has entered thermal regulation because the IC junction temperature has exceeded T_{J(REG)}

During each of these events, the internal timers are slowed down proportionately to the reduction in charging current. For example, if the charging current is reduced by half for two minutes, the timer clock is reduced to half the frequency and the counter counts half as fast resulting in only one minute of "counting" time.

If the pre charge timer expires before the battery voltage reaches V_{LOWV} , the bq2407x indicates a fault condition. Additionally, if the battery current does not fall to I_{TERM} before the fast charge timer expires, a fault is indicated. The \overline{CHG} output flashes at approximately 2 Hz to indicate a fault condition. The fault condition is cleared by toggling \overline{CE} or the input power, entering/ exiting USB suspend mode, or an OVP event.

STATUS INDICATORS (\overline{PGOOD} , \overline{CHG})

The bq2407x contains two open-drain outputs that signal its status. The \overline{PGOOD} output signals when a valid input source is connected. \overline{PGOOD} is low when $(V_{BAT} + V_{IN(DT)}) < V_{IN} < V_{OVP}$. When the input voltage is outside of this range, \overline{PGOOD} is high impedance.

The charge cycle after power-up, CE going low, or exiting OVP is indicated with the \overline{CHG} pin on (low - LED on), whereas all refresh (subsequent) charges will result in the \overline{CHG} pin off (open - LED off). In addition, the \overline{CHG} signals timer faults by flashing at approximately 2 Hz.

Table 2. \overline{PGOOD} STATUS INDICATOR

Input State	\overline{PGOOD} Output
$V_{IN} < V_{UVLO}$	Hi impedance
$V_{UVLO} < V_{IN} < V_{IN(DT)}$	Hi impedance
$V_{IN(DT)} < V_{IN} < V_{OVP}$	Low
$V_{IN} > V_{OVP}$	Hi impedance

Table 3. \overline{CHG} STATUS INDICATOR

Charge State	\overline{CHG} Output
Charging	Low (for first charge cycle)
Charging suspended by thermal loop	
Safety timers expired	Flashing at 2Hz
Charging done	Hi impedance
Recharging after termination	
IC disabled or no valid input power	
Battery absent	

THERMAL REGULATION AND THERMAL SHUTDOWN

The bq2407x contain a thermal regulation loop that monitors the die temperature. If the temperature exceeds $T_{J(REG)}$, the device automatically reduces the charging current to prevent the die temperature from increasing further. In some cases, the die temperature continues to rise despite the operation of the thermal loop, particularly under high V_{IN} and heavy OUT system load conditions. Under these conditions, if the die temperature increases to $T_{J(OFF)}$, the input FET Q1 is turned OFF. FET Q2 is turned ON to ensure that the battery still powers the load on OUT. Once the device die temperature cools by $T_{J(OFF-HYS)}$, the input FET Q1 is turned on and the device returns to thermal regulation. Continuous overtemperature conditions result in a "hiccup" mode. During thermal regulation, the safety timers are slowed down proportionately to the reduction in current limit.

Note that this feature monitors the die temperature of the bq2407x. This is not synonymous with ambient temperature. Self heating exists due to the power dissipated in the IC because of the linear nature of the battery charging algorithm and the LDO associated with OUT. A modified charge cycle with the thermal loop active is shown in [Figure 41](#). Battery termination is disabled during thermal regulation.

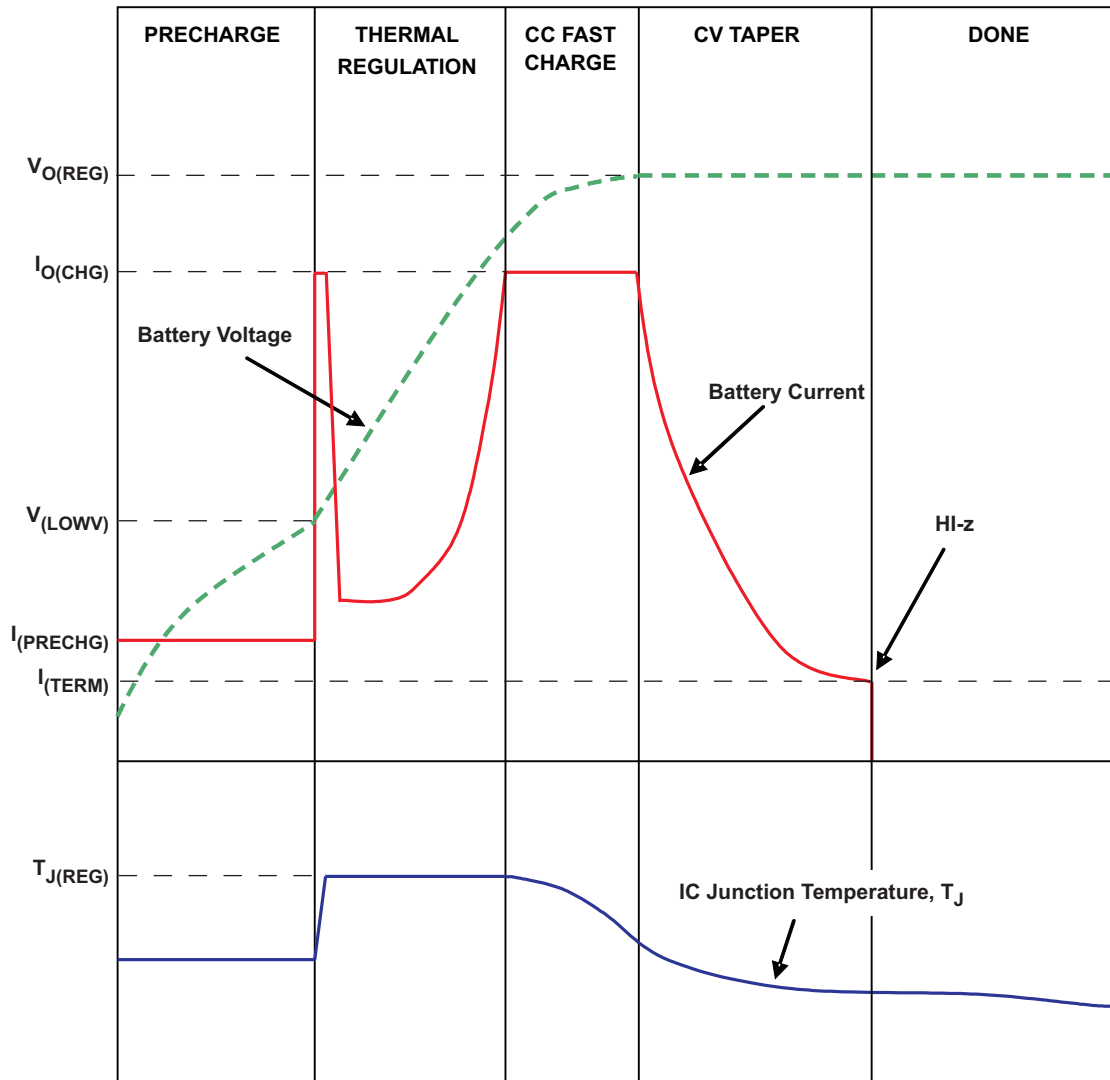

Figure 41. Charge Cycle Modified by Thermal Loop

BATTERY PACK TEMPERATURE MONITORING

The bq2407x features an external battery pack temperature monitoring input. The TS input connects to the NTC thermistor in the battery pack to monitor battery temperature and prevent dangerous over-temperature conditions. During charging, I_{NTC} is sourced to TS and the voltage at TS is continuously monitored. If, at any time, the voltage at TS is outside of the operating range (V_{COLD} to V_{HOT}), charging is suspended. The timers maintain their values but suspend counting. When the voltage measured at TS returns to within the operation window, charging is resumed and the timers continue counting. When charging is suspended due to a battery pack temperature fault, the \overline{CHG} pin remains low and continues to indicate *charging*.

For the bq24072 and bq24073, battery pack temperature sensing is disabled when termination is disabled ($TD = High$) and the voltage at TS is greater than $V_{DIS(TS)}$. For applications that do not require the TS monitoring function, connect a 10k Ω resistor from TS to VSS to set the TS voltage at a valid level and maintain charging.

The allowed temperature range for 103AT-2 type thermistor is 0°C to 50°C. However, the user may increase the range by adding two external resistors. See [Figure 42](#) for the circuit details. The values for R_s and R_p are calculated using the following equations:

$$R_s = \frac{-(R_{TH} + R_{TC}) \pm \sqrt{\left((R_{TH} + R_{TC})^2 - 4 \left\{ R_{TH} \times R_{TC} + \frac{V_H \times V_C}{(V_H - V_C) \times I_{TS}} \times (R_{TC} - R_{TH}) \right\} \right)}}{2} \quad (2)$$

$$R_p = \frac{V_H \times (R_{TH} + R_s)}{I_{TS} \times (R_{TH} + R_s) - V_H} \quad (3)$$

Where:

- R_{TH} : Thermistor Hot Trip Value found in thermistor data sheet
- R_{TC} : Thermistor Cold Trip Value found in thermistor data sheet
- V_H : IC's Hot Trip Threshold = 0.3V nominal
- V_C : IC's Cold Trip Threshold = 2.1V nominal
- I_{TS} : IC's Output Current Bias = 75 μ A nominal
- NTC Thermistor Semitec 103AT-4

R_s and R_p 1% values were chosen closest to calculated values

Cold Temp Resistance and Trip Threshold; Ω ($^{\circ}C$)	Hot Temp Resistance and Trip Threshold; Ω ($^{\circ}C$)	External Bias Resistor, R_s (Ω)	External Bias Resistor, R_p (Ω)
28000 (-0.6)	4000 (51)	0	∞
28480 (-1)	3536 (55)	487	845000
28480 (-1)	3021 (60)	1000	549000
33890 (-5)	4026 (51)	76.8	158000
33890 (-5)	3536 (55)	576	150000
33890 (-5)	3021 (60)	1100	140000

RHOT and RCOLD are the thermistor resistance at the desired hot and cold temperatures, respectively. **Note that the temperature window cannot be tightened more than using only the thermistor connected to TS, it can only be extended.**

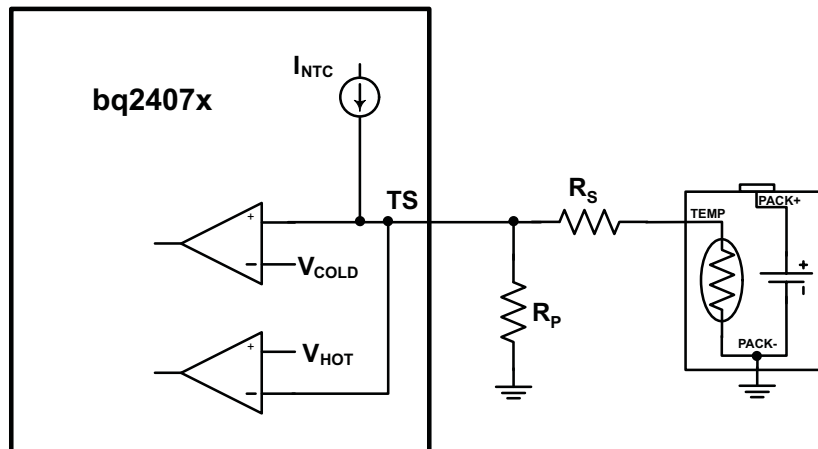

Figure 42. Extended TS Pin Thresholds

APPLICATIONS INFORMATION

bq2407x CHARGER DESIGN EXAMPLE

See [Figure 26](#) to [Figure 28](#) for Schematics of the Design Example.

Requirements

- Supply voltage = 5V
- Fast charge current of approximately 800 mA; ISET - pin 16
- Input Current Limit = 1.3A; ILIM - pin 12
- Termination Current Threshold = 110mA; ITERM – pin 15 (bq24074 only)
- Safety timer duration, Fast-Charge = 6.25 hours; TMR – pin 14
- TS – Battery Temperature Sense = 10kΩ NTC (103AT-2)

Calculations

Program the Fast Charge Current (ISET):

$$R_{ISET} = K_{ISET} / I_{CHG}$$

$K_{ISET} = 890 \text{ A}\Omega$ from the electrical characteristics table.

$$R_{ISET} = 890 \text{ A}\Omega / 0.8 \text{ A} = 1.1125 \text{ k}\Omega$$

Select the closest standard value, which for this case is 1.13kΩ. Connect this resistor between ISET (pin 16) and V_{SS} .

Program the Input Current Limit (ILIM)

$$R_{ILIM} = K_{ILIM} / I_{L_MAX}$$

$K_{ILIM} = 1550 \text{ A}\Omega$ from the electrical characteristics table.

$$R_{ISET} = 1550 \text{ A}\Omega / 1.3 \text{ A} = 1.192 \text{ k}\Omega$$

Select the closest standard value, which for this case is 1.18 kΩ. Connect this resistor between ILIM (pin 12) and V_{SS} .

Program the Termination Current Threshold (I_{TERM}) (bq24074 only)

$$R_{ITERM} = I_{TERM} \times R_{ISET} / 0.030$$

$R_{ISET} = 1.13 \text{ k}\Omega$ from the above calculation.

$$R_{ITERM} = 110 \text{ mA} \times 1.13 \text{ k}\Omega / 0.030 = 4.143 \text{ k}\Omega$$

Select the closest standard value, which for this case is 4.12kΩ. Connect this resistor between ITERM (pin 15) and V_{SS} . Note that when in USB100 mode ($EN1 = EN2 = V_{SS}$), the termination threshold is 1/3 of the normal threshold.

Program 6.25-hour Fast-Charge Safety Timer (TMR)

$$R_{TMR} = t_{MAXCHG} / (10 \times K_{TMR})$$

$K_{TMR} = 48 \text{ s/k}\Omega$ from the electrical characteristics table.

$$R_{TMR} = (6.25 \text{ hr} \times 3600 \text{ s/hr}) / (10 \times 48 \text{ s/k}\Omega) = 46.8 \text{ k}\Omega$$

Select the closest standard value, which for this case is 46.4 kΩ. Connect this resistor between TMR (pin 2) and V_{SS} .

TS Function

Use a 10kΩ NTC thermistor in the battery pack (103AT-2). For applications that do not require the TS monitoring function, connect a 10kΩ resistor from TS to V_{SS} to set the TS voltage at a valid level and maintain charging.

CHG and PGOOD

LED Status: connect a 1.5kΩ resistor in series with a LED between **OUT** and **CHG** to indicate charging status. Connect a 1.5kΩ resistor in series with a LED between **OUT** and **PGOOD** to indicate when a valid input source is connected.

Processor Monitoring Status: connect a pullup resistor (on the order of 100 kΩ) between the processor's power rail and **CHG** and **PGOOD**

Termination Disable (TD) (bq24072, bq24073 only)

Connect TD high to disable termination. Connect TD low to enable termination.

System ON/OFF (SYSOFF) (bq24075 or bq24079 only)

Connect SYSOFF high to disconnect the battery from the system load. Connect SYSOFF low for normal operation

SELECTING IN, OUT AND BAT pin CAPACITORS

In most applications, all that is needed is a high-frequency decoupling capacitor (ceramic) on the power pin, input, output and battery pins. Using the values shown on the application diagram, is recommended. After evaluation of these voltage signals with real system operational conditions, one can determine if capacitance values can be adjusted toward the minimum recommended values (DC load application) or higher values for fast high amplitude pulsed load applications. Note if designed high input voltage sources (bad adaptors or wrong adaptors), the capacitor needs to be rated appropriately. Ceramic capacitors are tested to 2x their rated values so a 16V capacitor may be adequate for a 30V transient (verify tested rating with capacitor manufacturer).

THERMAL PACKAGE

The bq24072/3/4/5 family is packaged in a thermally enhanced MLP package. The package includes a thermal pad to provide an effective thermal contact between the IC and the printed circuit board (PCB). The power pad should be directly connected to the V_{SS} pin. Full PCB design guidelines for this package are provided in the application note entitled: QFN/SON PCB Attachment Application Note ([SLUA271](#)). The most common measure of package thermal performance is thermal impedance (θ_{JA}) measured (or modeled) from the chip junction to the air surrounding the package surface (ambient). The mathematical expression for θ_{JA} is:

$$\theta_{JA} = (T_J - T) / P$$

Where:

T_J = chip junction temperature

T = ambient temperature

P = device power dissipation

Factors that can influence the measurement and calculation of θ_{JA} include:

1. Whether or not the device is board mounted
2. Trace size, composition, thickness, and geometry
3. Orientation of the device (horizontal or vertical)
4. Volume of the ambient air surrounding the device under test and airflow
5. Whether other surfaces are in close proximity to the device being tested

Due to the charge profile of Li-Ion batteries the maximum power dissipation is typically seen at the beginning of the charge cycle when the battery voltage is at its lowest. Typically after fast charge begins the pack voltage increases to $\approx 3.4V$ within the first 2 minutes. The thermal time constant of the assembly typically takes a few minutes to heat up so when doing maximum power dissipation calculations, 3.4V is a good minimum voltage to use. This is verified, with the system and a fully discharged battery, by plotting temperature on the bottom of the PCB under the IC (pad should have multiple vias), the charge current and the battery voltage as a function of time. The fast charge current will start to taper off if the part goes into thermal regulation.

The device power dissipation, P, is a function of the charge rate and the voltage drop across the internal PowerFET. It can be calculated from the following equation when a battery pack is being charged :

$$P = [V_{(IN)} - V_{(OUT)}] \times I_{(OUT)} + [V_{(OUT)} - V_{(BAT)}] \times I_{(BAT)} \quad (3)$$

The thermal loop feature reduces the charge current to limit excessive IC junction temperature. It is recommended that the design not run in thermal regulation for typical operating conditions (nominal input voltage and nominal ambient temperatures) and use the feature for non typical situations such as hot environments or higher than normal input source voltage. With that said, the IC will still perform as described, if the thermal loop is always active.

Half-Wave Adaptors

Some adapters implement a half rectifier topology, which causes the adapter output voltage to fall below the battery voltage during part of the cycle. To enable operation with adapters under those conditions, the bq2407x family keeps the charger on for at least 20 msec (typical) after the input power puts the part in sleep mode. This feature enables use of external adapters using 50 Hz networks. The input must not drop below the UVLO voltage for the charger to work properly. Thus, the battery voltage should be above the UVLO to help prevent the input from dropping out. Additional input capacitance may be needed.

Sleep Mode

When the input is between UVLO and $V_{IN(DT)}$, the device enters sleep mode. After entering sleep mode for >20mS the internal FET connection between the IN and OUT pin is disabled and pulling the input to ground will not discharge the battery, other than the leakage on the BAT pin. If one has a full 1000mAh battery and the leakage is 10µA, then it would take 1000mAh/10µA = 100000 hours (11.4 years) to discharge the battery. The battery's self discharge is typically 5 times higher than this.

Layout Tips

- To obtain optimal performance, the decoupling capacitor from IN to GND (thermal pad) and the output filter capacitors from OUT to GND (thermal pad) should be placed as close as possible to the bq2407x, with short trace runs to both IN, OUT and GND (thermal pad).
- All low-current GND connections should be kept separate from the high-current charge or discharge paths from the battery. Use a single-point ground technique incorporating both the small signal ground path and the power ground path.
- The high current charge paths into IN pin and from the OUT pin must be sized appropriately for the maximum charge current in order to avoid voltage drops in these traces
- The bq2407x family is packaged in a thermally enhanced MLP package. The package includes a thermal pad to provide an effective thermal contact between the IC and the printed circuit board (PCB); this thermal pad is also the main ground connection for the device. Connect the thermal pad to the PCB ground connection. Full PCB design guidelines for this package are provided in the application note entitled: QFN/SON PCB Attachment Application Note ([SLUA271](#)).

REVISION HISTORY

Note: Page numbers of current revision may differ from previous versions.

Changes from Original (September 2008) to Revision A	Page
• Changed device Features.	1
• Changed Description.	1
• Changed Typical Application Circuit	1
• Changed description of $\overline{\text{CHG}}$ pin.	6
• Changed SYSOFF Description.	7
• Changed the Simplified Block Diagram	8
• Added Figure 4 through Figure 11	9
• Changed APPLICATION CIRCUITS section.	12
• Added Using bq24075 to Disconnect the Battery from the System, Figure 28	13
• Changed DETAILED FUNCTIONAL DESCRIPTION section.	16
• Changed text in section - STATUS INDICATORS ($\overline{\text{PGOOD}}$, $\overline{\text{CHG}}$)	25
• Changed Table - $\overline{\text{CHG}}$ STATUS INDICATOR	25
• Changed Equation 2 and Equation 3	27
• Changed section - Half-Wave Adaptors	31

Changes from Revision A (December 2008) to Revision B	Page
• Changed $V_{\text{BAT(REG)}}$ max value From 4.24 V To: 4.23 V	5

Changes from Revision B (January 2009) to Revision C	Page
• Changed Maximum input current factor values.	4

Changes from Revision C (March 2009) to Revision D	Page
• Added Device number bq24079.	1

Changes from Revision D (June 2009) to Revision E	Page
• Changed globally RT1 and RT2 to Rs and Rp	27
• Added equations 2 and 3 plus explanations and table	27

Changes from Revision E (August 2010) to Revision F	Page
• Changed 10 x 45 s/k Ω to 10 x 48 s/k Ω under section Program 6.25hour.....(TMR)	29

Changes from Revision F (September 2010) to Revision G	Page
• Added ESD human body model specification to Abs Maximum Ratings table.	3

Changes from Revision G (July 2011) to Revision H	Page
• Changed I_{CHG} Battery fast charge current range MIN specification from "300 mA" to "150 mA"	5

Changes from Revision H (December 2013) to Revision I**Page**

-
- Changed R_{ISET} spec MAX value from "3000" to "5900" in the Recommended Operating Conditions table. [3](#)
 - Changed resistor value from "3 k Ω " to "5.9 k Ω " in the Pin Functions table ISET Description paragraph. [7](#)
 - Changed resistor value from "3 k Ω " to "5.9 k Ω " in the Battery Charging section paragraph. [22](#)
-

PACKAGING INFORMATION

Orderable Device	Status (1)	Package Type	Package Drawing	Pins	Package Qty	Eco Plan (2)	Lead/Ball Finish (6)	MSL Peak Temp (3)	Op Temp (°C)	Device Marking (4/5)	Samples
BQ24072RGTR	ACTIVE	QFN	RGT	16	3000	Green (RoHS & no Sb/Br)	CU NIPDAU	Level-2-260C-1 YEAR	-40 to 85	CKP	Samples
BQ24072RGTRG4	ACTIVE	QFN	RGT	16	3000	Green (RoHS & no Sb/Br)	CU NIPDAU	Level-2-260C-1 YEAR	-40 to 85	CKP	Samples
BQ24072RGTT	ACTIVE	QFN	RGT	16	250	Green (RoHS & no Sb/Br)	CU NIPDAU	Level-2-260C-1 YEAR	-40 to 85	CKP	Samples
BQ24072RGTTG4	ACTIVE	QFN	RGT	16	250	Green (RoHS & no Sb/Br)	CU NIPDAU	Level-2-260C-1 YEAR	-40 to 85	CKP	Samples
BQ24073RGTR	ACTIVE	QFN	RGT	16	3000	Green (RoHS & no Sb/Br)	CU NIPDAU	Level-2-260C-1 YEAR	-40 to 85	CKQ	Samples
BQ24073RGTRG4	ACTIVE	QFN	RGT	16	3000	Green (RoHS & no Sb/Br)	CU NIPDAU	Level-2-260C-1 YEAR	-40 to 85	CKQ	Samples
BQ24073RGTT	ACTIVE	QFN	RGT	16	250	Green (RoHS & no Sb/Br)	CU NIPDAU	Level-2-260C-1 YEAR	-40 to 85	CKQ	Samples
BQ24073RGTTG4	ACTIVE	QFN	RGT	16	250	Green (RoHS & no Sb/Br)	CU NIPDAU	Level-2-260C-1 YEAR	-40 to 85	CKQ	Samples
BQ24074RGTR	ACTIVE	QFN	RGT	16	3000	Green (RoHS & no Sb/Br)	CU NIPDAU	Level-2-260C-1 YEAR	-40 to 85	BZF	Samples
BQ24074RGTRG4	ACTIVE	QFN	RGT	16	3000	Green (RoHS & no Sb/Br)	CU NIPDAU	Level-2-260C-1 YEAR	-40 to 85	BZF	Samples
BQ24074RGTT	ACTIVE	QFN	RGT	16	250	Green (RoHS & no Sb/Br)	CU NIPDAU	Level-2-260C-1 YEAR	-40 to 85	BZF	Samples
BQ24075RGTR	ACTIVE	QFN	RGT	16	3000	Green (RoHS & no Sb/Br)	CU NIPDAU	Level-2-260C-1 YEAR	-40 to 85	CDU	Samples
BQ24075RGTRG4	ACTIVE	QFN	RGT	16	3000	Green (RoHS & no Sb/Br)	CU NIPDAU	Level-2-260C-1 YEAR	-40 to 85	CDU	Samples
BQ24075RGTT	ACTIVE	QFN	RGT	16	250	Green (RoHS & no Sb/Br)	CU NIPDAU	Level-2-260C-1 YEAR	-40 to 85	CDU	Samples
BQ24075RGTTG4	ACTIVE	QFN	RGT	16	250	Green (RoHS & no Sb/Br)	CU NIPDAU	Level-2-260C-1 YEAR	-40 to 85	CDU	Samples
BQ24079RGTR	ACTIVE	QFN	RGT	16	3000	Green (RoHS & no Sb/Br)	CU NIPDAU	Level-2-260C-1 YEAR	-40 to 85	ODI	Samples
BQ24079RGTT	ACTIVE	QFN	RGT	16	250	Green (RoHS & no Sb/Br)	CU NIPDAU	Level-2-260C-1 YEAR	-40 to 85	ODI	Samples

(1) The marketing status values are defined as follows:

ACTIVE: Product device recommended for new designs.

LIFEBUY: TI has announced that the device will be discontinued, and a lifetime-buy period is in effect.

NRND: Not recommended for new designs. Device is in production to support existing customers, but TI does not recommend using this part in a new design.

PREVIEW: Device has been announced but is not in production. Samples may or may not be available.

OBSOLETE: TI has discontinued the production of the device.

(2) Eco Plan - The planned eco-friendly classification: Pb-Free (RoHS), Pb-Free (RoHS Exempt), or Green (RoHS & no Sb/Br) - please check <http://www.ti.com/productcontent> for the latest availability information and additional product content details.

TBD: The Pb-Free/Green conversion plan has not been defined.

Pb-Free (RoHS): TI's terms "Lead-Free" or "Pb-Free" mean semiconductor products that are compatible with the current RoHS requirements for all 6 substances, including the requirement that lead not exceed 0.1% by weight in homogeneous materials. Where designed to be soldered at high temperatures, TI Pb-Free products are suitable for use in specified lead-free processes.

Pb-Free (RoHS Exempt): This component has a RoHS exemption for either 1) lead-based flip-chip solder bumps used between the die and package, or 2) lead-based die adhesive used between the die and leadframe. The component is otherwise considered Pb-Free (RoHS compatible) as defined above.

Green (RoHS & no Sb/Br): TI defines "Green" to mean Pb-Free (RoHS compatible), and free of Bromine (Br) and Antimony (Sb) based flame retardants (Br or Sb do not exceed 0.1% by weight in homogeneous material)

(3) MSL, Peak Temp. - The Moisture Sensitivity Level rating according to the JEDEC industry standard classifications, and peak solder temperature.

(4) There may be additional marking, which relates to the logo, the lot trace code information, or the environmental category on the device.

(5) Multiple Device Markings will be inside parentheses. Only one Device Marking contained in parentheses and separated by a "~" will appear on a device. If a line is indented then it is a continuation of the previous line and the two combined represent the entire Device Marking for that device.

(6) Lead/Ball Finish - Orderable Devices may have multiple material finish options. Finish options are separated by a vertical ruled line. Lead/Ball Finish values may wrap to two lines if the finish value exceeds the maximum column width.

Important Information and Disclaimer: The information provided on this page represents TI's knowledge and belief as of the date that it is provided. TI bases its knowledge and belief on information provided by third parties, and makes no representation or warranty as to the accuracy of such information. Efforts are underway to better integrate information from third parties. TI has taken and continues to take reasonable steps to provide representative and accurate information but may not have conducted destructive testing or chemical analysis on incoming materials and chemicals. TI and TI suppliers consider certain information to be proprietary, and thus CAS numbers and other limited information may not be available for release.

In no event shall TI's liability arising out of such information exceed the total purchase price of the TI part(s) at issue in this document sold by TI to Customer on an annual basis.

OTHER QUALIFIED VERSIONS OF BQ24075 :

- Automotive: [BQ24075-Q1](#)

NOTE: Qualified Version Definitions:

- Automotive - Q100 devices qualified for high-reliability automotive applications targeting zero defects

TAPE AND REEL INFORMATION

QUADRANT ASSIGNMENTS FOR PIN 1 ORIENTATION IN TAPE

*All dimensions are nominal

Device	Package Type	Package Drawing	Pins	SPQ	Reel Diameter (mm)	Reel Width W1 (mm)	A0 (mm)	B0 (mm)	K0 (mm)	P1 (mm)	W (mm)	Pin1 Quadrant
BQ24072RGTR	QFN	RGT	16	3000	330.0	12.4	3.3	3.3	1.1	8.0	12.0	Q2
BQ24072RGTT	QFN	RGT	16	250	330.0	12.4	3.3	3.3	1.1	8.0	12.0	Q2
BQ24073RGTR	QFN	RGT	16	3000	330.0	12.4	3.3	3.3	1.1	8.0	12.0	Q2
BQ24073RGTT	QFN	RGT	16	250	180.0	12.4	3.3	3.3	1.1	8.0	12.0	Q2
BQ24074RGTR	QFN	RGT	16	3000	330.0	12.4	3.3	3.3	1.1	8.0	12.0	Q2
BQ24074RGTT	QFN	RGT	16	250	180.0	12.4	3.3	3.3	1.1	8.0	12.0	Q2
BQ24075RGTR	QFN	RGT	16	3000	330.0	12.4	3.3	3.3	1.1	8.0	12.0	Q2
BQ24075RGTR	QFN	RGT	16	3000	330.0	12.4	3.3	3.3	1.1	8.0	12.0	Q2
BQ24075RGTT	QFN	RGT	16	250	330.0	12.4	3.3	3.3	1.1	8.0	12.0	Q2
BQ24075RGTT	QFN	RGT	16	250	180.0	12.4	3.3	3.3	1.1	8.0	12.0	Q2
BQ24079RGTR	QFN	RGT	16	3000	330.0	12.4	3.3	3.3	1.1	8.0	12.0	Q2
BQ24079RGTT	QFN	RGT	16	250	180.0	12.4	3.3	3.3	1.1	8.0	12.0	Q2

TAPE AND REEL BOX DIMENSIONS

*All dimensions are nominal

Device	Package Type	Package Drawing	Pins	SPQ	Length (mm)	Width (mm)	Height (mm)
BQ24072RGTR	QFN	RGT	16	3000	367.0	367.0	35.0
BQ24072RGTT	QFN	RGT	16	250	338.0	355.0	50.0
BQ24073RGTR	QFN	RGT	16	3000	367.0	367.0	35.0
BQ24073RGTT	QFN	RGT	16	250	210.0	185.0	35.0
BQ24074RGTR	QFN	RGT	16	3000	367.0	367.0	35.0
BQ24074RGTT	QFN	RGT	16	250	210.0	185.0	35.0
BQ24075RGTR	QFN	RGT	16	3000	338.0	355.0	50.0
BQ24075RGTR	QFN	RGT	16	3000	367.0	367.0	35.0
BQ24075RGTT	QFN	RGT	16	250	338.0	355.0	50.0
BQ24075RGTT	QFN	RGT	16	250	210.0	185.0	35.0
BQ24079RGTR	QFN	RGT	16	3000	367.0	367.0	35.0
BQ24079RGTT	QFN	RGT	16	250	210.0	185.0	35.0

RGT (S-PVQFN-N16)

PLASTIC QUAD FLATPACK NO-LEAD



4203495/H 10/11

- NOTES:
- All linear dimensions are in millimeters. Dimensioning and tolerancing per ASME Y14.5M-1994.
 - This drawing is subject to change without notice.
 - Quad Flatpack, No-leads (QFN) package configuration.
 - The package thermal pad must be soldered to the board for thermal and mechanical performance.
 - See the additional figure in the Product Data Sheet for details regarding the exposed thermal pad features and dimensions.
 - Falls within JEDEC MO-220.

THERMAL PAD MECHANICAL DATA

RGT (S-PVQFN-N16)

PLASTIC QUAD FLATPACK NO-LEAD

THERMAL INFORMATION

This package incorporates an exposed thermal pad that is designed to be attached directly to an external heatsink. The thermal pad must be soldered directly to the printed circuit board (PCB). After soldering, the PCB can be used as a heatsink. In addition, through the use of thermal vias, the thermal pad can be attached directly to the appropriate copper plane shown in the electrical schematic for the device, or alternatively, can be attached to a special heatsink structure designed into the PCB. This design optimizes the heat transfer from the integrated circuit (IC).

For information on the Quad Flatpack No-Lead (QFN) package and its advantages, refer to Application Report, QFN/SON PCB Attachment, Texas Instruments Literature No. SLUA271. This document is available at www.ti.com.

The exposed thermal pad dimensions for this package are shown in the following illustration.

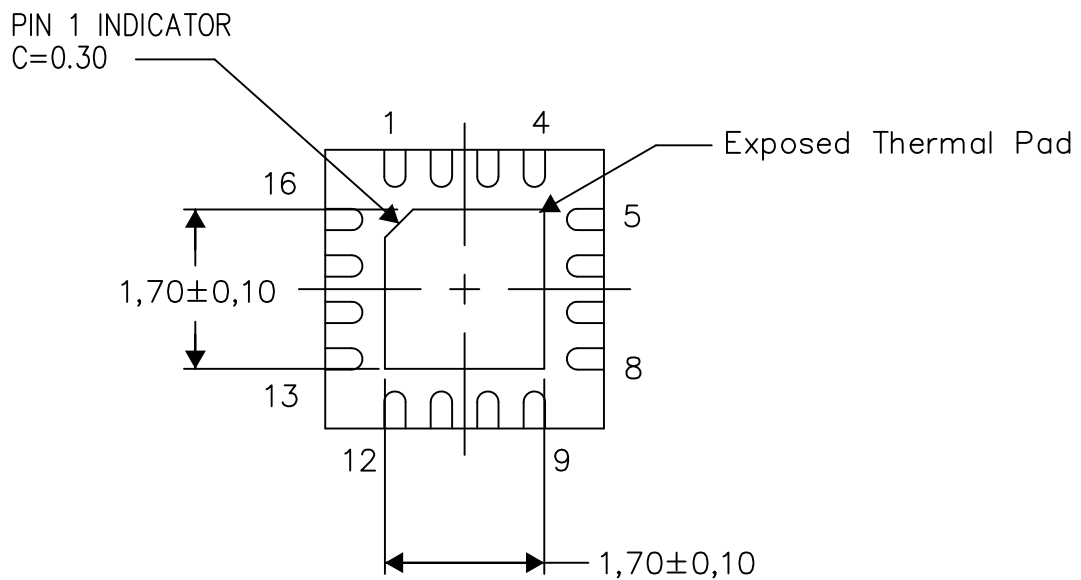

Exposed Thermal Pad Dimensions

4206349-4/U 09/13

NOTE: All linear dimensions are in millimeters

RGT (S-PVQFN-N16)

PLASTIC QUAD FLATPACK NO-LEAD

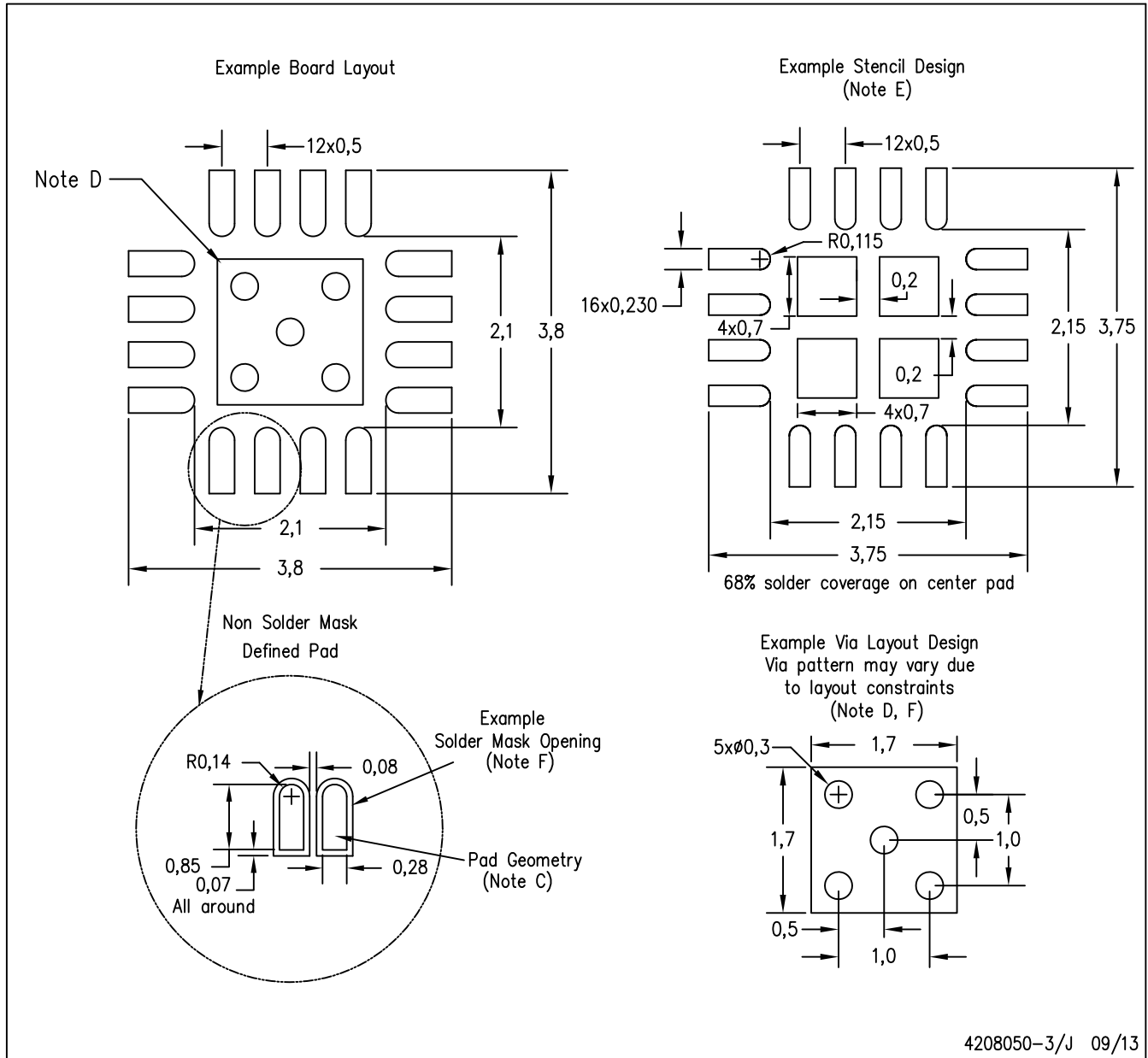

- NOTES:
- A. All linear dimensions are in millimeters.
 - B. This drawing is subject to change without notice.
 - C. Publication IPC-7351 is recommended for alternate designs.
 - D. This package is designed to be soldered to a thermal pad on the board. Refer to Application Note, QFN/SON PCB Attachment, Texas Instruments Literature No. SLUA271, and also the Product Data Sheets for specific thermal information, via requirements, and recommended board layout. These documents are available at www.ti.com <<http://www.ti.com>>.
 - E. Laser cutting apertures with trapezoidal walls and also rounding corners will offer better paste release. Customers should contact their board assembly site for stencil design recommendations. Refer to IPC 7525 for stencil design considerations.
 - F. Customers should contact their board fabrication site for minimum solder mask web tolerances between signal pads.

IMPORTANT NOTICE

Texas Instruments Incorporated and its subsidiaries (TI) reserve the right to make corrections, enhancements, improvements and other changes to its semiconductor products and services per JESD46, latest issue, and to discontinue any product or service per JESD48, latest issue. Buyers should obtain the latest relevant information before placing orders and should verify that such information is current and complete. All semiconductor products (also referred to herein as "components") are sold subject to TI's terms and conditions of sale supplied at the time of order acknowledgment.

TI warrants performance of its components to the specifications applicable at the time of sale, in accordance with the warranty in TI's terms and conditions of sale of semiconductor products. Testing and other quality control techniques are used to the extent TI deems necessary to support this warranty. Except where mandated by applicable law, testing of all parameters of each component is not necessarily performed.

TI assumes no liability for applications assistance or the design of Buyers' products. Buyers are responsible for their products and applications using TI components. To minimize the risks associated with Buyers' products and applications, Buyers should provide adequate design and operating safeguards.

TI does not warrant or represent that any license, either express or implied, is granted under any patent right, copyright, mask work right, or other intellectual property right relating to any combination, machine, or process in which TI components or services are used. Information published by TI regarding third-party products or services does not constitute a license to use such products or services or a warranty or endorsement thereof. Use of such information may require a license from a third party under the patents or other intellectual property of the third party, or a license from TI under the patents or other intellectual property of TI.

Reproduction of significant portions of TI information in TI data books or data sheets is permissible only if reproduction is without alteration and is accompanied by all associated warranties, conditions, limitations, and notices. TI is not responsible or liable for such altered documentation. Information of third parties may be subject to additional restrictions.

Resale of TI components or services with statements different from or beyond the parameters stated by TI for that component or service voids all express and any implied warranties for the associated TI component or service and is an unfair and deceptive business practice. TI is not responsible or liable for any such statements.

Buyer acknowledges and agrees that it is solely responsible for compliance with all legal, regulatory and safety-related requirements concerning its products, and any use of TI components in its applications, notwithstanding any applications-related information or support that may be provided by TI. Buyer represents and agrees that it has all the necessary expertise to create and implement safeguards which anticipate dangerous consequences of failures, monitor failures and their consequences, lessen the likelihood of failures that might cause harm and take appropriate remedial actions. Buyer will fully indemnify TI and its representatives against any damages arising out of the use of any TI components in safety-critical applications.

In some cases, TI components may be promoted specifically to facilitate safety-related applications. With such components, TI's goal is to help enable customers to design and create their own end-product solutions that meet applicable functional safety standards and requirements. Nonetheless, such components are subject to these terms.

No TI components are authorized for use in FDA Class III (or similar life-critical medical equipment) unless authorized officers of the parties have executed a special agreement specifically governing such use.

Only those TI components which TI has specifically designated as military grade or "enhanced plastic" are designed and intended for use in military/aerospace applications or environments. Buyer acknowledges and agrees that any military or aerospace use of TI components which have **not** been so designated is solely at the Buyer's risk, and that Buyer is solely responsible for compliance with all legal and regulatory requirements in connection with such use.

TI has specifically designated certain components as meeting ISO/TS16949 requirements, mainly for automotive use. In any case of use of non-designated products, TI will not be responsible for any failure to meet ISO/TS16949.

Products

Audio	www.ti.com/audio
Amplifiers	amplifier.ti.com
Data Converters	dataconverter.ti.com
DLP® Products	www.dlp.com
DSP	dsp.ti.com
Clocks and Timers	www.ti.com/clocks
Interface	interface.ti.com
Logic	logic.ti.com
Power Mgmt	power.ti.com
Microcontrollers	microcontroller.ti.com
RFID	www.ti-rfid.com
OMAP Applications Processors	www.ti.com/omap
Wireless Connectivity	www.ti.com/wirelessconnectivity

Applications

Automotive and Transportation	www.ti.com/automotive
Communications and Telecom	www.ti.com/communications
Computers and Peripherals	www.ti.com/computers
Consumer Electronics	www.ti.com/consumer-apps
Energy and Lighting	www.ti.com/energy
Industrial	www.ti.com/industrial
Medical	www.ti.com/medical
Security	www.ti.com/security
Space, Avionics and Defense	www.ti.com/space-avionics-defense
Video and Imaging	www.ti.com/video

TI E2E Community

e2e.ti.com