

## FEATURES

- 1.5 pF off source capacitance
- <1 pC charge injection
- 33 V supply range
- 120 Ω on resistance
- Fully specified at ±15 V, +12 V
- No V<sub>L</sub> supply required
- 3 V logic-compatible inputs
- Rail-to-rail operation
- 14-lead TSSOP and 12-lead LFCSP
- Typical power consumption < 0.03 μW

## APPLICATIONS

- Automatic test equipment
- Data acquisition systems
- Battery-powered systems
- Sample-and-hold systems
- Audio signal routing
- Video signal routing
- Communication systems

## GENERAL DESCRIPTION

The **ADG1204** is a complementary metal-oxide semiconductor (CMOS) analog multiplexer, comprising four single channels designed on an *i*CMOS (industrial CMOS) process. *i*CMOS® is a modular manufacturing process that combines high voltage CMOS and bipolar technologies. It enables the development of a wide range of high performance analog ICs capable of 33 V operation in a footprint that no previous generation of high voltage devices has been able to achieve. Unlike analog ICs using conventional CMOS processes, *i*CMOS components can tolerate high supply voltages while providing increased performance, dramatically lower power consumption, and reduced package size.

The ultralow capacitance and charge injection of this multiplexer makes it an ideal solution for data acquisition and sample-and-hold applications, where low glitch and fast settling are required. Fast switching speed coupled with high signal bandwidth makes the device suitable for video signal switching. *i*CMOS construction ensures ultralow power dissipation, making the device ideally suited for portable and battery-powered instruments.

## FUNCTIONAL BLOCK DIAGRAM

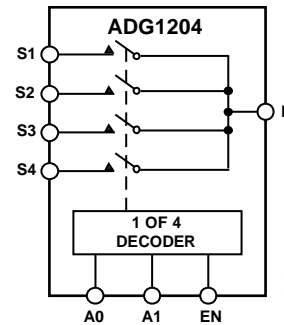

Figure 1.

The **ADG1204** switches one of four inputs to a common output, D, as determined by the 3-bit binary address lines: A0, A1, and EN. Logic 0 on the EN pin disables the device. Each switch conducts equally well in both directions when on and has an input signal range that extends to the supplies. In the off condition, signal levels up to the supplies are blocked. All switches exhibit break-before-make switching action.

## PRODUCT HIGHLIGHTS

1. 1.5 pF off capacitance (±15 V supply).
2. <1 pC charge injection.
3. 3 V logic-compatible digital inputs: V<sub>IH</sub> = 2.0 V, V<sub>IL</sub> = 0.8 V.
4. No V<sub>L</sub> logic power supply required.
5. Ultralow power dissipation: <0.03 μW.
6. 14-lead TSSOP and 12-lead, 3 mm × 3 mm LFCSP packages.

## TABLE OF CONTENTS

Features .....	1	ESD Caution.....	7
Applications.....	1	Pin Configurations and Function Descriptions .....	8
Functional Block Diagram .....	1	Truth Table .....	8
General Description .....	1	Typical Performance Characteristics .....	9
Product Highlights .....	1	Test Circuits.....	12
Revision History .....	2	Terminology .....	14
Specifications.....	3	Outline Dimensions .....	15
Dual Supply .....	3	Ordering Guide .....	15
Single Supply .....	5		
Absolute Maximum Ratings.....	7		

## REVISION HISTORY

### 3/16—Rev. B to Rev. C

Changed LFCSP_VQ to LFCSP.....	Throughout
Changes to Figure 3.....	8
Updated Outline Dimensions .....	15
Changes to Ordering Guide .....	15

### 2/09—Rev. A to Rev. B

Changes to Power Requirements, $I_{DD}$ , Digital Inputs = 5 V Parameter, Table 1.....	4
Changes to Power Requirements, $I_{DD}$ , Digital Inputs = 5 V Parameter, Table 2.....	6
Updated Outline Dimensions .....	15

### 7/06—Rev. 0 to Rev. A

Updated Format.....	Universal
Changes to Table 1.....	3
Changes to Table 2.....	5
Changes to the Terminology Section.....	14

### 7/05—Revision 0: Initial Version

# SPECIFICATIONS

## DUAL SUPPLY

$V_{DD} = 15\text{ V} \pm 10\%$ ,  $V_{SS} = -15\text{ V} \pm 10\%$ , GND = 0 V, unless otherwise noted.

Table 1.

Parameter	Y Version <sup>1</sup>			Unit	Test Conditions/Comments
	25°C	-40°C to +85°C	-40°C to +125°C		
<b>ANALOG SWITCH</b>					
Analog Signal Range			$V_{DD}$ to $V_{SS}$	V	
On Resistance ( $R_{ON}$ )	120			$\Omega$ typ	$V_S = \pm 10\text{ V}$ , $I_S = -1\text{ mA}$ ; see Figure 21
	190	230	260	$\Omega$ max	$V_{DD} = +13.5\text{ V}$ , $V_{SS} = -13.5\text{ V}$
On Resistance Match Between Channels ( $\Delta R_{ON}$ )	3.5			$\Omega$ typ	$V_S = \pm 10\text{ V}$ , $I_S = -1\text{ mA}$
	6	10	12	$\Omega$ max	
On Resistance Flatness ( $R_{FLAT(ON)}$ )	20			$\Omega$ typ	$V_S = -5\text{ V}, 0\text{ V}, +5\text{ V}$ ; $I_S = -1\text{ mA}$
	57	72	79	$\Omega$ max	
<b>LEAKAGE CURRENTS</b>					
Source Off Leakage, $I_S$ (OFF)	$\pm 0.02$			nA typ	$V_{DD} = +16.5\text{ V}$ , $V_{SS} = -16.5\text{ V}$
	$\pm 0.1$	$\pm 0.6$	$\pm 1$	nA max	$V_S = \pm 10\text{ V}$ , $V_D = \mp 10\text{ V}$ ; see Figure 22
Drain Off Leakage, $I_D$ (OFF)	$\pm 0.02$			nA typ	$V_S = \pm 10\text{ V}$ , $V_D = \mp 10\text{ V}$ ; see Figure 22
	$\pm 0.1$	$\pm 0.6$	$\pm 1$	nA max	
Channel On Leakage, $I_D$ , $I_S$ (ON)	$\pm 0.02$			nA typ	$V_S = V_D = \pm 10\text{ V}$ ; see Figure 23
	$\pm 0.2$	$\pm 0.6$	$\pm 1$	nA max	
<b>DIGITAL INPUTS</b>					
Input High Voltage, $V_{INH}$			2.0	V min	
Input Low Voltage, $V_{INL}$			0.8	V max	
Input Current, $I_{INL}$ or $I_{INH}$	0.005			$\mu\text{A}$ typ	$V_{IN} = V_{INL}$ or $V_{INH}$
			$\pm 0.1$	$\mu\text{A}$ max	
Digital Input Capacitance, $C_{IN}$	2.5			pF typ	
<b>DYNAMIC CHARACTERISTICS<sup>2</sup></b>					
Transition Time, $t_{TRANS}$	120			ns typ	$R_L = 300\ \Omega$ , $C_L = 35\text{ pF}$
	150	180	200	ns max	$V_S = 10\text{ V}$ ; see Figure 24
$t_{ON}$ (EN)	70			ns typ	$R_L = 300\ \Omega$ , $C_L = 35\text{ pF}$
	85	100	110	ns max	$V_S = 10\text{ V}$ ; see Figure 26
$t_{OFF}$ (EN)	90			ns typ	$R_L = 300\ \Omega$ , $C_L = 35\text{ pF}$
	110	135	155	ns max	$V_S = 10\text{ V}$ ; see Figure 26
Break-Before-Make Time Delay, $t_D$	25			ns typ	$R_L = 300\ \Omega$ , $C_L = 35\text{ pF}$
			10	ns min	$V_{S1} = V_{S2} = 10\text{ V}$ ; see Figure 25
Charge Injection	-0.7			pC typ	$V_S = 0\text{ V}$ , $R_S = 0\ \Omega$ , $C_L = 1\text{ nF}$ ; see Figure 27
Off Isolation	85			dB typ	$R_L = 50\ \Omega$ , $C_L = 5\text{ pF}$ , $f = 1\text{ MHz}$ ; see Figure 28
Channel-to-Channel Crosstalk	80			dB typ	$R_L = 50\ \Omega$ , $C_L = 5\text{ pF}$ , $f = 1\text{ MHz}$ ; see Figure 30
Total Harmonic Distortion + Noise	0.15			% typ	$R_L = 10\text{ k}\Omega$ , $5\text{ V rms}$ , $f = 20\text{ Hz to } 20\text{ kHz}$ ; see Figure 31
Bandwidth -3 dB	800			MHz typ	$R_L = 50\ \Omega$ , $C_L = 5\text{ pF}$ ; see Figure 29
$C_S$ (OFF)	1.2			pF typ	$f = 1\text{ MHz}$ , $V_S = 0\text{ V}$
	1.5			pF max	$f = 1\text{ MHz}$ , $V_S = 0\text{ V}$
$C_D$ (OFF)	3.6			pF typ	$f = 1\text{ MHz}$ , $V_S = 0\text{ V}$
	4.2			pF max	$f = 1\text{ MHz}$ , $V_S = 0\text{ V}$
$C_D$ , $C_S$ (ON)	5.5			pF typ	$f = 1\text{ MHz}$ , $V_S = 0\text{ V}$
	6.5			pF max	$f = 1\text{ MHz}$ , $V_S = 0\text{ V}$

Parameter	Y Version <sup>1</sup>			Unit	Test Conditions/Comments
	25°C	-40°C to +85°C	-40°C to +125°C		
POWER REQUIREMENTS					$V_{DD} = +16.5\text{ V}$ , $V_{SS} = -16.5\text{ V}$
$I_{DD}$	0.001			$\mu\text{A typ}$	Digital inputs = 0 V or $V_{DD}$
			1.0	$\mu\text{A max}$	
$I_{DD}$	170			$\mu\text{A typ}$	Digital inputs = 5 V
			285	$\mu\text{A max}$	
$I_{SS}$	0.001			$\mu\text{A typ}$	Digital inputs = 0 V or $V_{DD}$
			1.0	$\mu\text{A max}$	
$I_{SS}$	0.001			$\mu\text{A typ}$	Digital inputs = 5 V
			1.0	$\mu\text{A max}$	

<sup>1</sup> Y version temperature range is -40°C to +125°C.

<sup>2</sup> Guaranteed by design, not subject to production test.

**SINGLE SUPPLY**

$V_{DD} = 12\text{ V} \pm 10\%$ ,  $V_{SS} = 0\text{ V}$ ,  $GND = 0\text{ V}$ , unless otherwise noted.

**Table 2.**

Parameter	Y Version <sup>1</sup>			Unit	Test Conditions/Comments
	25°C	-40°C to +85°C	-40°C to +125°C		
<b>ANALOG SWITCH</b>					
Analog Signal Range			0 V to $V_{DD}$	V	
On Resistance ( $R_{ON}$ )	300			$\Omega$ typ	$V_S = 0\text{ V to }10\text{ V}$ , $I_S = -1\text{ mA}$ ; see Figure 21
	475	567	625	$\Omega$ max	$V_{DD} = 10.8\text{ V}$ , $V_{SS} = 0\text{ V}$
On Resistance Match Between Channels ( $\Delta R_{ON}$ )	5			$\Omega$ typ	$V_S = 0\text{ V to }10\text{ V}$ , $I_S = -1\text{ mA}$
	16	26	27	$\Omega$ max	
On Resistance Flatness ( $R_{FLAT(ON)}$ )	60			$\Omega$ typ	$V_S = 3\text{ V, }6\text{ V, }9\text{ V}$ ; $I_S = -1\text{ mA}$
<b>LEAKAGE CURRENTS</b>					
Source Off Leakage, $I_S$ (OFF)	$\pm 0.02$			nA typ	$V_{DD} = 13.2\text{ V}$
	$\pm 0.1$	$\pm 0.6$	$\pm 1$	nA max	$V_S = 1\text{ V/}10\text{ V}$ , $V_D = 10\text{ V/}1\text{ V}$ ; see Figure 22
Drain Off Leakage, $I_D$ (OFF)	$\pm 0.02$			nA typ	$V_S = 1\text{ V/}10\text{ V}$ , $V_D = 10\text{ V/}1\text{ V}$ ; see Figure 22
	$\pm 0.1$	$\pm 0.6$	$\pm 1$	nA max	
Channel On Leakage, $I_D, I_S$ (ON)	$\pm 0.02$			nA typ	$V_S = V_D = 1\text{ V or }10\text{ V}$ ; see Figure 23
	$\pm 0.2$	$\pm 0.6$	$\pm 1$	nA max	
<b>DIGITAL INPUTS</b>					
Input High Voltage, $V_{INH}$			2.0	V min	
Input Low Voltage, $V_{INL}$			0.8	V max	
Input Current, $I_{INL}$ or $I_{INH}$	0.001			$\mu\text{A}$ typ	$V_{IN} = V_{INL}$ or $V_{INH}$
			$\pm 0.1$	$\mu\text{A}$ max	
Digital Input Capacitance, $C_{IN}$	2.5			pF typ	
<b>DYNAMIC CHARACTERISTICS<sup>2</sup></b>					
Transition Time, $t_{TRANS}$	150			ns typ	$R_L = 300\ \Omega$ , $C_L = 35\text{ pF}$
	190	240	265	ns max	$V_S = 8\text{ V}$ ; see Figure 24
$t_{ON}$ (EN)	95			ns typ	$R_L = 300\ \Omega$ , $C_L = 35\text{ pF}$
	120	150	170	ns max	$V_S = 8\text{ V}$ ; see Figure 26
$t_{OFF}$ (EN)	100			ns typ	$R_L = 300\ \Omega$ , $C_L = 35\text{ pF}$
	125	155	170	ns max	$V_S = 8\text{ V}$ ; see Figure 26
Break-Before-Make Time Delay, $t_D$	50			ns typ	$R_L = 300\ \Omega$ , $C_L = 35\text{ pF}$
			10	ns min	$V_{S1} = V_{S2} = 8\text{ V}$ ; see Figure 25
Charge Injection	-0.4			pC typ	$V_S = 6\text{ V}$ , $R_S = 0\ \Omega$ , $C_L = 1\text{ nF}$ ; see Figure 27
Off Isolation	85			dB typ	$R_L = 50\ \Omega$ , $C_L = 5\text{ pF}$ , $f = 1\text{ MHz}$ ; see Figure 28
Channel-to-Channel Crosstalk	80			dB typ	$R_L = 50\ \Omega$ , $C_L = 5\text{ pF}$ , $f = 1\text{ MHz}$ ; see Figure 30
Bandwidth -3 db	550			MHz typ	$R_L = 50\ \Omega$ , $C_L = 5\text{ pF}$ ; see Figure 29
$C_S$ (OFF)	1.2			pF typ	$f = 1\text{ MHz}$ ; $V_S = 6\text{ V}$
	1.5			pF max	$f = 1\text{ MHz}$ ; $V_S = 6\text{ V}$
$C_D$ (OFF)	3.6			pF typ	$f = 1\text{ MHz}$ ; $V_S = 6\text{ V}$
	4.2			pF max	$f = 1\text{ MHz}$ ; $V_S = 6\text{ V}$
$C_D, C_S$ (ON)	5.5			pF typ	$f = 1\text{ MHz}$ ; $V_S = 6\text{ V}$
	6.5			pF max	$f = 1\text{ MHz}$ ; $V_S = 6\text{ V}$

Parameter	Y Version <sup>1</sup>			Unit	Test Conditions/Comments
	25°C	-40°C to +85°C	-40°C to +125°C		
POWER REQUIREMENTS					$V_{DD} = 13.2\text{ V}$
$I_{DD}$	0.001		1.0	$\mu\text{A typ}$ $\mu\text{A max}$	Digital inputs = 0 V or $V_{DD}$
$I_{DD}$	170		285	$\mu\text{A typ}$ $\mu\text{A max}$	Digital inputs = 5 V

<sup>1</sup> Y version temperature range is -40°C to +125°C.

<sup>2</sup> Guaranteed by design, not subject to production test.

## ABSOLUTE MAXIMUM RATINGS

$T_A = 25^\circ\text{C}$ , unless otherwise noted.

**Table 3.**

Parameter	Rating
$V_{DD}$ to $V_{SS}$	35 V
$V_{DD}$ to GND	-0.3 V to +25 V
$V_{SS}$ to GND	+0.3 V to -25 V
Analog Inputs <sup>1</sup>	$V_{SS} - 0.3\text{ V}$ to $V_{DD} + 0.3\text{ V}$ or 30 mA, whichever occurs first
Digital Inputs <sup>1</sup>	GND - 0.3 V to $V_{DD} + 0.3\text{ V}$ or 30 mA, whichever occurs first
Peak Current, S or D	100 mA (pulsed at 1 ms, 10% duty cycle maximum)
Continuous Current	45 mA
Operating Temperature Range	
Automotive (Y Version)	-40°C to +125°C
Storage Temperature Range	-65°C to +150°C
Junction Temperature	150°C
14-Lead TSSOP, $\theta_{JA}$ Thermal Impedance (4-Layer Board)	112°C/W
12-Lead LFCSP, $\theta_{JA}$ Thermal Impedance	80°C/W
Reflow Soldering Peak Temperature, Pb Free	260°C

<sup>1</sup> Overvoltages at IN, S, or D are clamped by internal diodes. Current must be limited to the maximum ratings given.

Stresses at or above those listed under Absolute Maximum Ratings may cause permanent damage to the product. This is a stress rating only; functional operation of the product at these or any other conditions above those indicated in the operational section of this specification is not implied. Operation beyond the maximum operating conditions for extended periods may affect product reliability.

Only one absolute maximum rating can be applied at any one time.

### ESD CAUTION



**ESD (electrostatic discharge) sensitive device.** Charged devices and circuit boards can discharge without detection. Although this product features patented or proprietary protection circuitry, damage may occur on devices subjected to high energy ESD. Therefore, proper ESD precautions should be taken to avoid performance degradation or loss of functionality.

### PIN CONFIGURATIONS AND FUNCTION DESCRIPTIONS

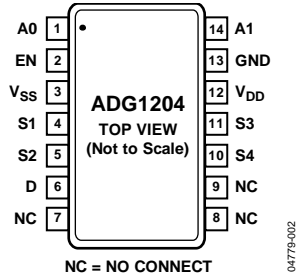

Figure 2. TSSOP Pin Configuration

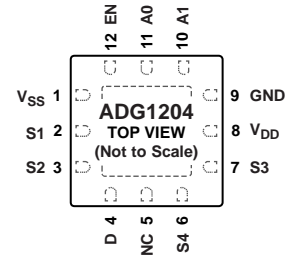

Figure 3. LFCSP Pin Configuration

Table 4. Pin Function Descriptions

Pin No.		Mnemonic	Description
TSSOP	LFCSP		
1	11	A0	Logic Control Input.
2	12	EN	Active High Digital Input. When low, the device is disabled and all switches are off. When high, Ax logic inputs determine on switches.
3	1	V <sub>SS</sub>	Most Negative Power Supply Potential.
4	2	S1	Source Terminal. Can be an input or an output.
5	3	S2	Source Terminal. Can be an input or an output.
6	4	D	Drain Terminal. Can be an input or an output.
7 to 9	5	NC	No Connection.
10	6	S4	Source Terminal. Can be an input or an output.
11	7	S3	Source Terminal. Can be an input or an output.
12	8	V <sub>DD</sub>	Most Positive Power Supply Potential.
13	9	GND	Ground (0 V) Reference.
14	10	A1	Logic Control Input.

### TRUTH TABLE

Table 5.

EN	A1	A0	S1	S2	S3	S4
0	X	X	Off	Off	Off	Off
1	0	0	On	Off	Off	Off
1	0	1	Off	On	Off	Off
1	1	0	Off	Off	On	Off
1	1	1	Off	Off	Off	On



### TYPICAL PERFORMANCE CHARACTERISTICS

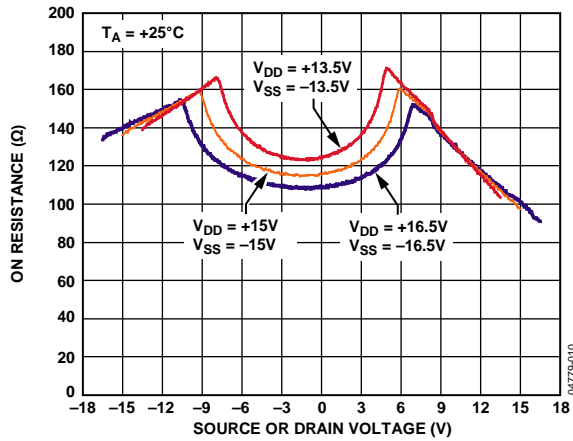

Figure 4. On Resistance as a Function of  $V_D$  ( $V_S$ ), Dual Supply

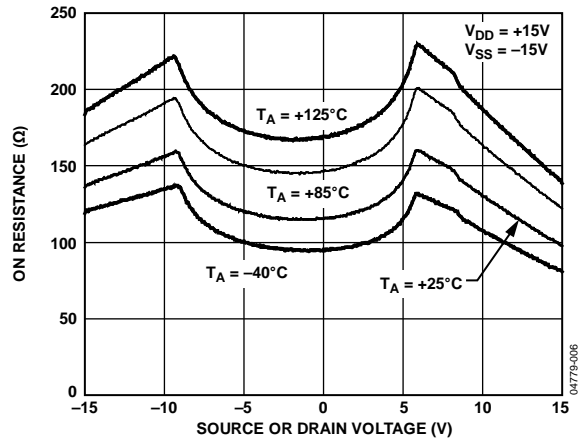

Figure 7. On Resistance as a Function of  $V_D$  ( $V_S$ ) for Different Temperatures, Dual Supply

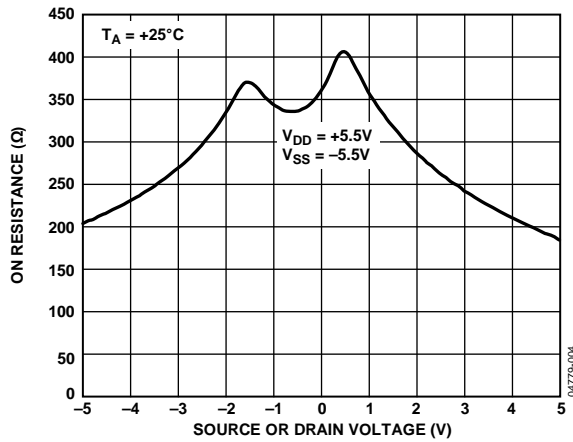

Figure 5. On Resistance as a Function of  $V_D$  ( $V_S$ ), Dual Supply

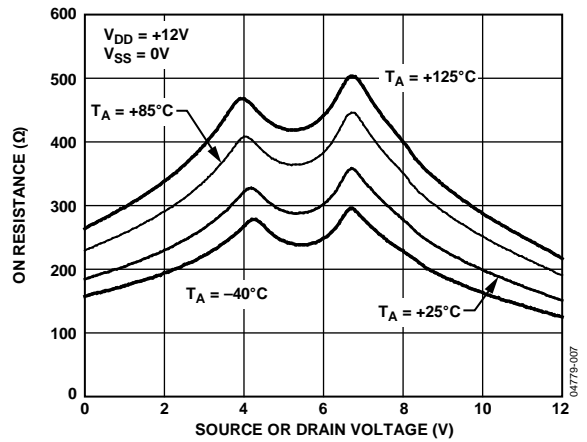

Figure 8. On Resistance as a Function of  $V_D$  ( $V_S$ ) for Different Temperatures, Single Supply

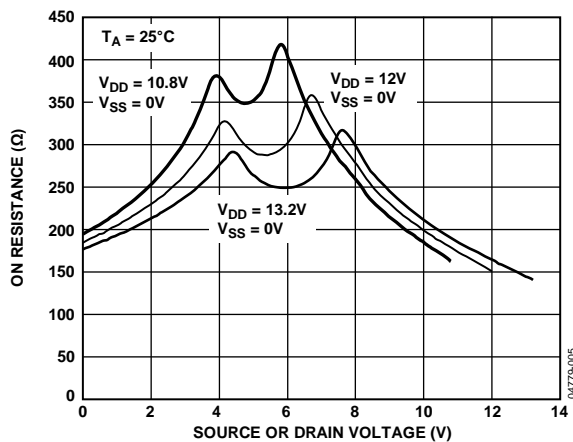

Figure 6. On Resistance as a Function of  $V_D$  ( $V_S$ ), Single Supply

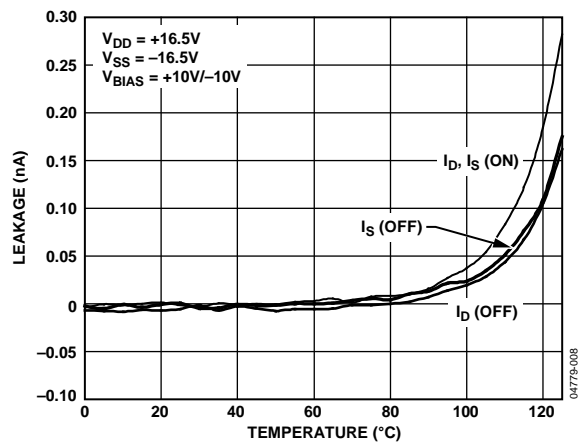

Figure 9. Leakage Currents as a Function of Temperature, Dual Supply

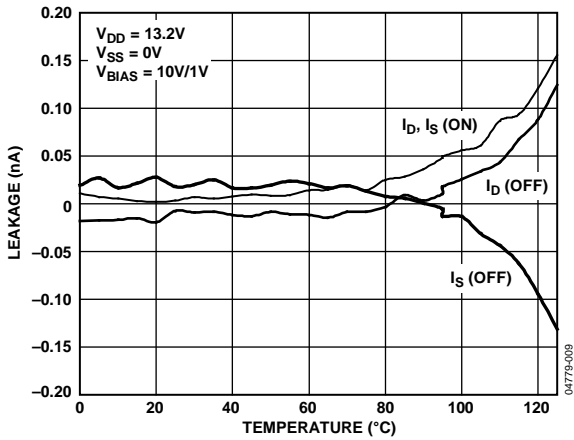

Figure 10. Leakage Currents as a Function of Temperature, Single Supply

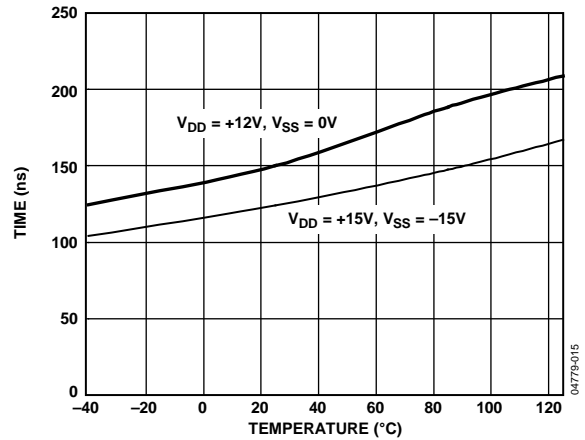

Figure 13. Transition Times vs. Temperature

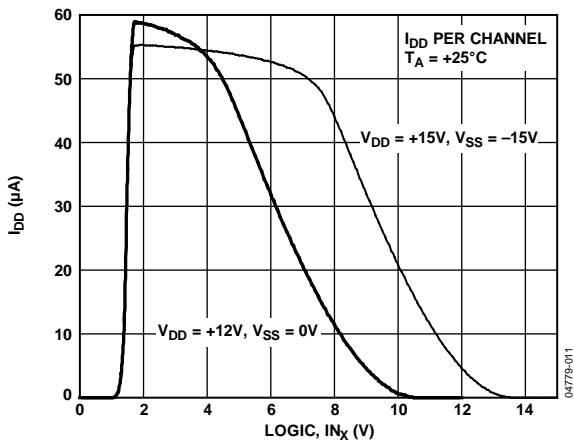

Figure 11.  $I_{DD}$  vs. Logic Level

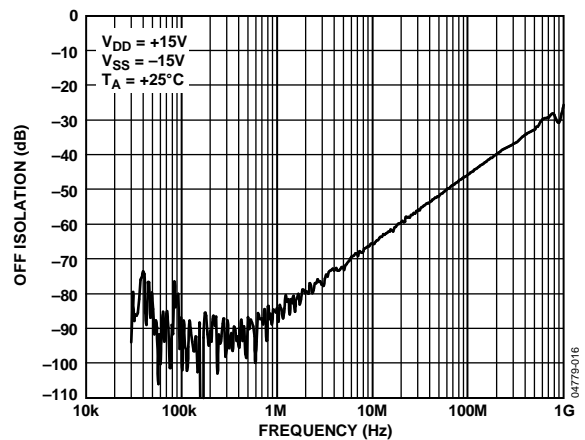

Figure 14. Off Isolation vs. Frequency

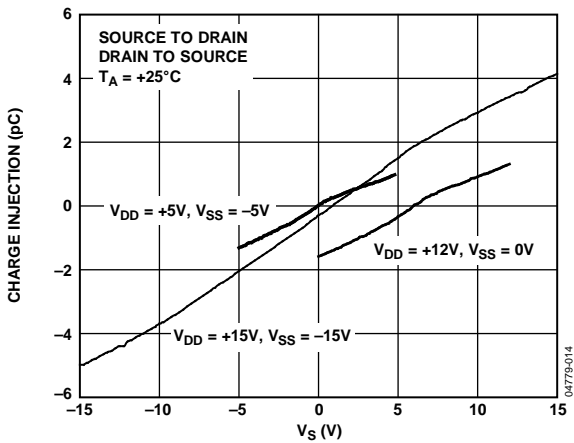

Figure 12. Charge Injection vs. Source Voltage

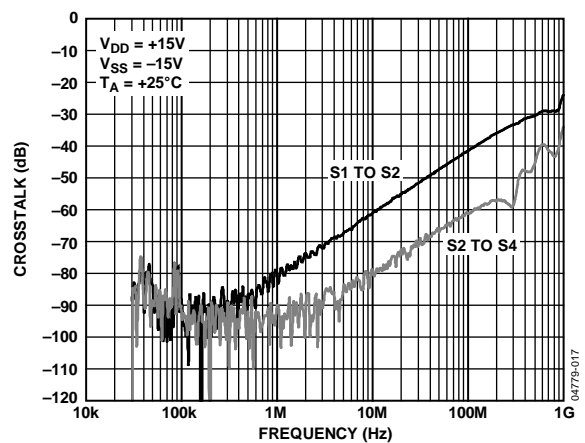

Figure 15. Crosstalk vs. Frequency

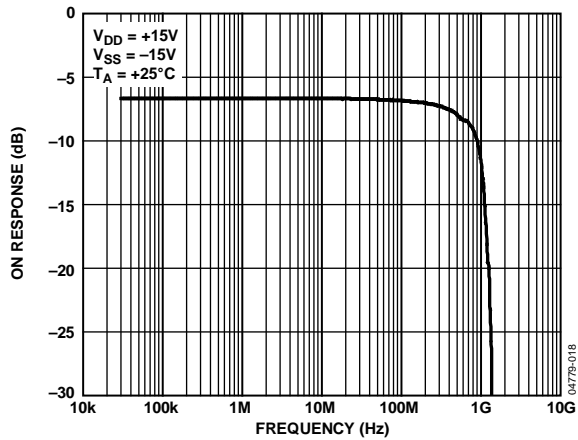

Figure 16. On Response vs. Frequency

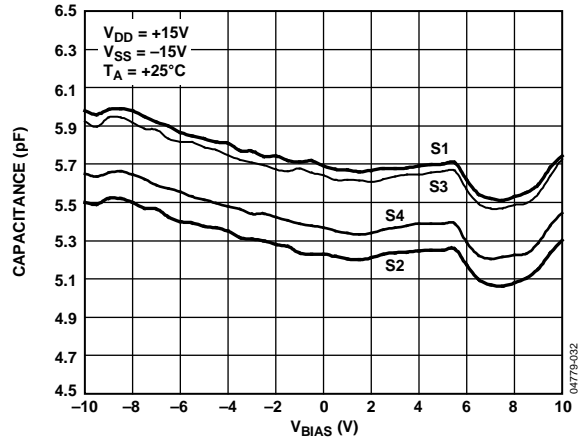

Figure 19. On Capacitance vs. Source Voltage

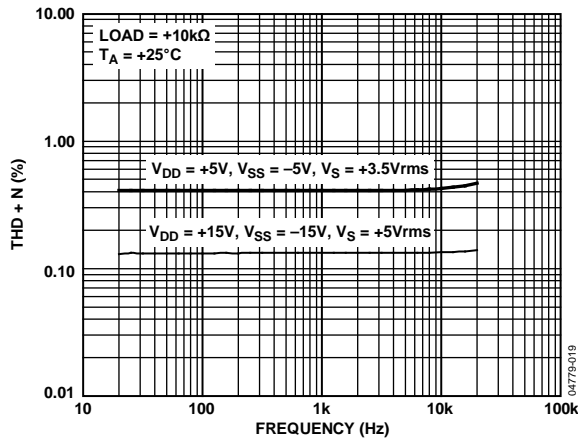

Figure 17. THD + N vs. Frequency

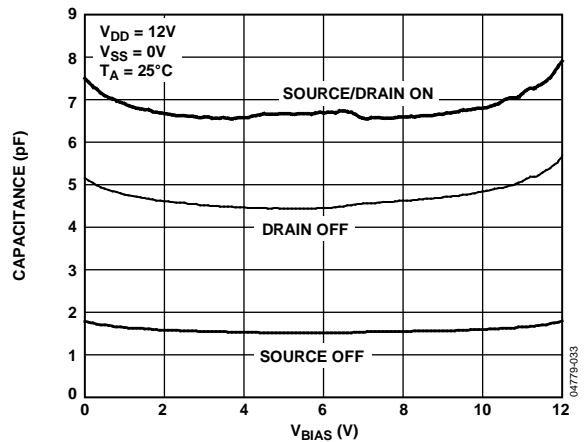

Figure 20. Capacitance vs. Source Voltage, Single Supply

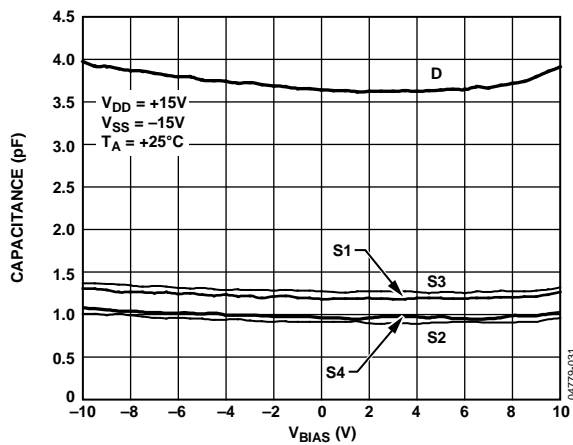

Figure 18. Off Capacitance vs. Source Voltage

TEST CIRCUITS

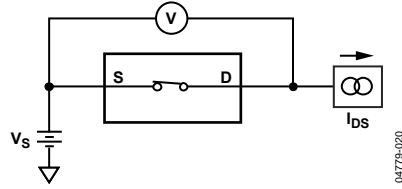

Figure 21. On Resistance

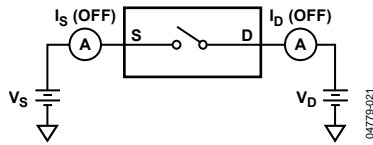

Figure 22. Off Leakage

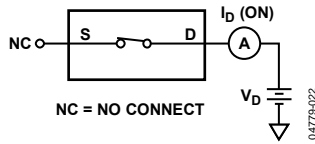

Figure 23. On Leakage

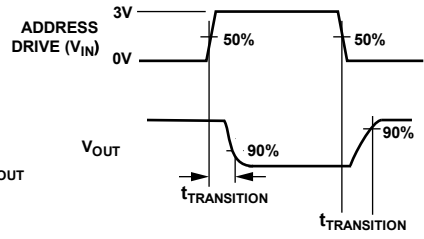
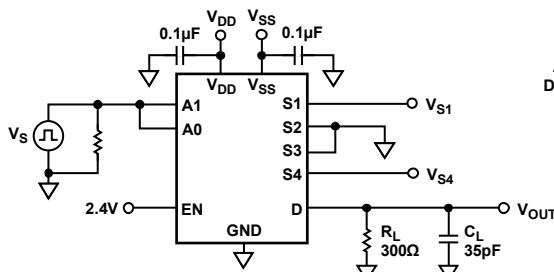

Figure 24. Address to Output Switching Times

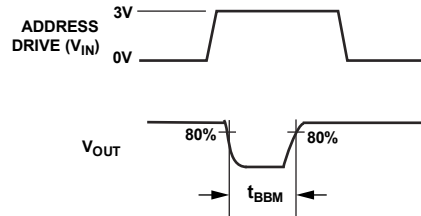
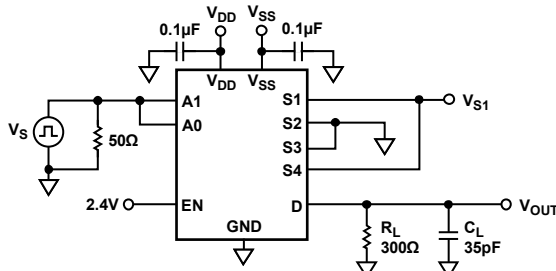

Figure 25. Break-Before-Make Time Delay

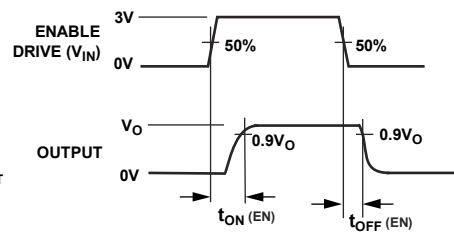
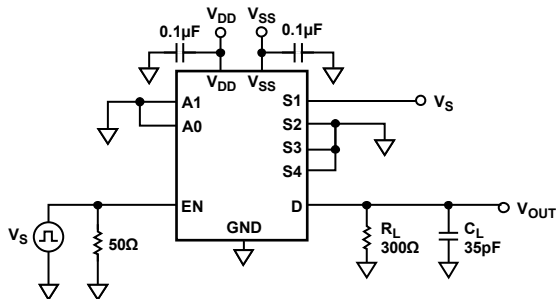

Figure 26. Enable-to-Output Switching Delay

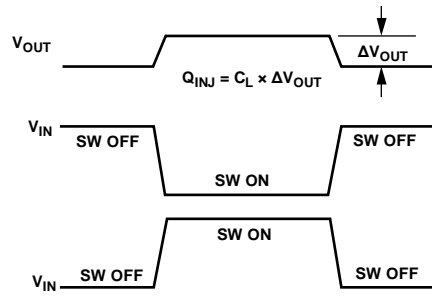
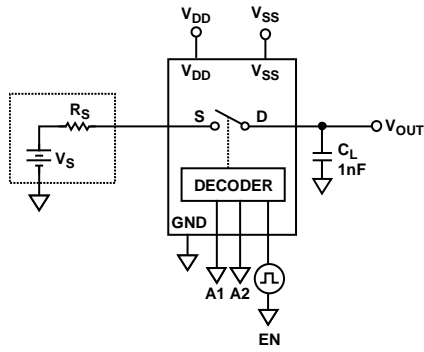
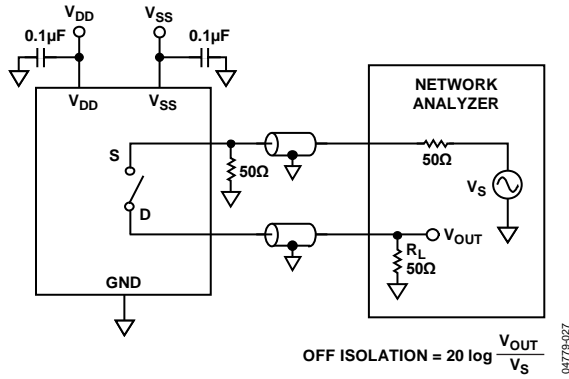
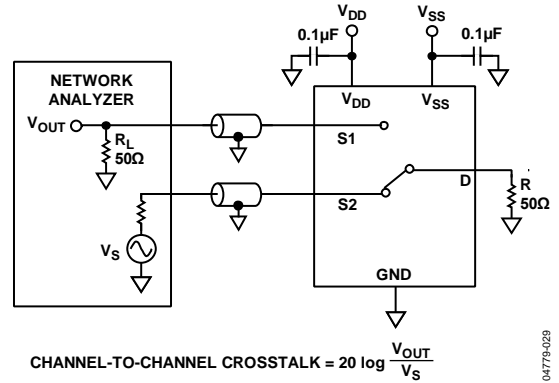

Figure 27. Charge Injection



$$\text{OFF ISOLATION} = 20 \log \frac{V_{\text{OUT}}}{V_S}$$

Figure 28. Off Isolation



$$\text{CHANNEL-TO-CHANNEL CROSSTALK} = 20 \log \frac{V_{\text{OUT}}}{V_S}$$

Figure 30. Channel-to-Channel Crosstalk

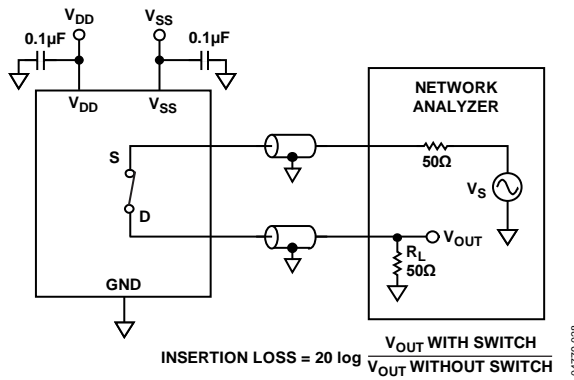

$$\text{INSERTION LOSS} = 20 \log \frac{V_{\text{OUT WITH SWITCH}}}{V_{\text{OUT WITHOUT SWITCH}}}$$

Figure 29. Bandwidth

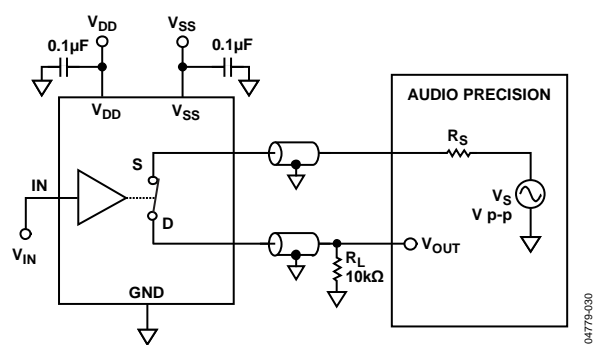

Figure 31. THD + Noise

## TERMINOLOGY

### $I_{DD}$

The positive supply current.

### $I_{SS}$

The negative supply current.

### $V_D (V_S)$

The analog voltage on Terminal D and Terminal S.

### $R_{ON}$

The ohmic resistance between D and S.

### $R_{FLAT(ON)}$

Flatness is defined as the difference between the maximum and minimum value of on resistance, as measured over the specified analog signal range.

### $I_S (OFF)$

The source leakage current with the switch off.

### $I_D (OFF)$

The drain leakage current with the switch off.

### $I_D, I_S (ON)$

The channel leakage current with the switch on.

### $V_{INL}$

The maximum input voltage for Logic 0.

### $V_{INH}$

The minimum input voltage for Logic 1.

### $I_{INL} (I_{INH})$

The input current of the digital input.

### $C_S (OFF)$

The off switch source capacitance, which is measured with reference to ground.

### $C_D (OFF)$

The off switch drain capacitance, which is measured with reference to ground.

### $C_D, C_S (On)$

The on switch capacitance, measured with reference to ground.

### $C_{IN}$

The digital input capacitance.

### $t_{ON} (EN)$

The delay between applying the digital control input and the output switching on.

### $t_{OFF} (EN)$

The delay between applying the digital control input and the output switching off.

### $t_{TRANS}$

The delay time between the 50% and 90% points of the digital input and switch on condition when switching from one address state to another.

### Charge Injection

A measure of the glitch impulse transferred from the digital input to the analog output during switching.

### Off Isolation

A measure of unwanted signal coupling through an off switch.

### Crosstalk

A measure of unwanted signal that is coupled through from one channel to another as a result of parasitic capacitance.

### Bandwidth

The frequency at which the output is attenuated by -3 dB.

### On Response

The frequency response of the on switch.

### Insertion Loss

The loss due to the on resistance of the switch.

### Total Harmonic Distortion + Noise (THD + N)

The ratio of the harmonic amplitude plus noise of the signal to the fundamental.

OUTLINE DIMENSIONS

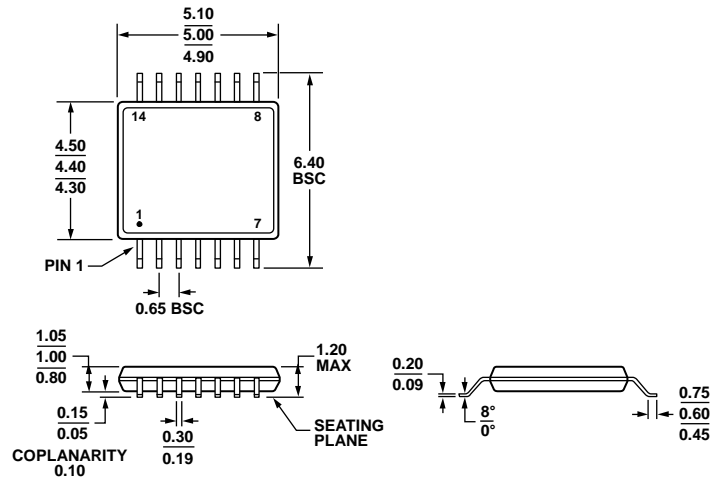

COMPLIANT TO JEDEC STANDARDS MO-153-AB-1

Figure 32. 14-Lead Thin Shrink Small Outline Package [TSSOP] (RU-14)

Dimensions shown in millimeters

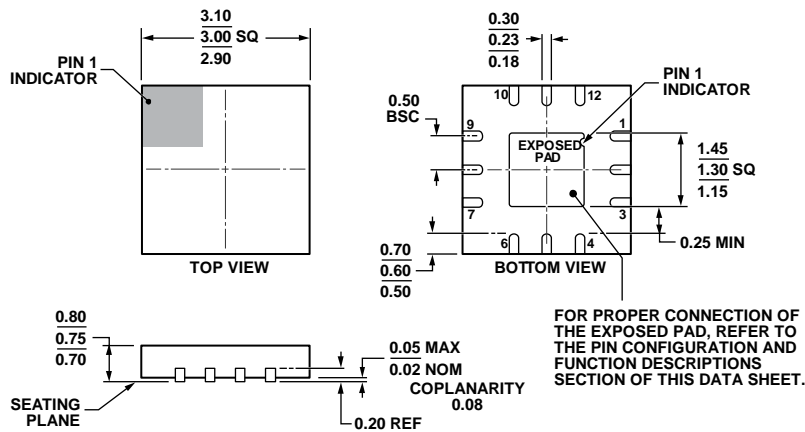

COMPLIANT TO JEDEC STANDARDS MO-220-WEED.

Figure 33. 12-Lead Lead Frame Chip Scale Package [LFCSP] 3 mm x 3 mm Body and 0.75 mm Package Height (CP-12-4)

Dimensions shown in millimeters

ORDERING GUIDE

Model <sup>1</sup>	Temperature Range	Package Description	Package Option
ADG1204YRUZ	-40°C to +125°C	14-Lead Thin Shrink Small Outline Package [TSSOP]	RU-14
ADG1204YRUZ-REEL	-40°C to +125°C	14-Lead Thin Shrink Small Outline Package [TSSOP]	RU-14
ADG1204YRUZ-REEL7	-40°C to +125°C	14-Lead Thin Shrink Small Outline Package [TSSOP]	RU-14
ADG1204YCPZ-500RL7	-40°C to +125°C	12-Lead Lead Frame Chip Scale Package [LFCSP]	CP-12-4
ADG1204YCPZ-REEL7	-40°C to +125°C	12-Lead Lead Frame Chip Scale Package [LFCSP]	CP-12-4

<sup>1</sup> Z = RoHS Compliant Part.

**NOTES**