

TPS7A33 –36V、1A、超低噪声负电压稳压器

1 特性

- 输入电压范围：–3V 至 –36V
- 噪声：
 - 16 μ V_{RMS} (10Hz 至 100kHz)
- 电源纹波抑制：
 - 72dB (10kHz)
- 可调输出：–1.18V 至 –33V
- 最大输出电流：1A
- 与 $\geq 10\mu$ F 的陶瓷电容搭配使用时可保持稳定
- 内置电流值限制和热关断保护
- 采用外部散热，高耐热性能 TO-220 封装
- 工作温度范围：–40°C 至 125°C

2 应用

- 用于运算放大器，数模转换器 (DAC)，模数转换器 (ADC)，和其他高精度模拟电路的电源轨
- 音频
- 后置 DC/DC 转换器稳压和纹波滤除
- 测试和测量
- 医疗
- 工业仪表
- 基站和电信基础设施
- 12V 和 24V 工业总线

3 说明

TPS7A33 系列线性稳压器是负电压 (–36V)，超低噪声 (16 μ V_{RMS}, 72dB PSRR) 线性稳压器，能够为最高 1A 负载供电。

TPS7A33 系列产品装有一个补偿金属氧化物半导体 (CMOS) 逻辑电平兼容使能引脚 (EN)，此引脚允许可由用户定制电源管理方案。其它提供的特性包括内置电流值限制和热关断以在故障情况下保护此器件和系统。

由于在设计中主要使用双极技术，TPS7A33 适合于高准确度，高精度测量仪器应用，在此类应用中，为了获得最大的系统性能，规整的电压轨很关键。此特性使得此款器件非常适合为运算放大器，模数转换器 (ADC)，数模转换器 (DAC)，和其它高性能模拟电路供电。

此外，TPS7A33 系列线性稳压器适用于后置 DC/DC 转换器稳压。通过滤除 DC/DC 开关转换所固有的输出电压纹波，可确保在灵敏仪器仪表、医疗、测试和测量、音频和射频 (RF) 应用中实现系统性能最优化。

对于需要正负高性能电源轨的应用，还可以考虑采用 [TPS7A4700](#) 正向高电压、超低噪声、低压降线性稳压器。

器件信息⁽¹⁾

器件型号	封装	封装尺寸 (标称值)
TPS7A33	TO-220 (7)	10.17mm x 8.38mm
	超薄四方扁平无引线封装 (VQFN) (20)	5.00mm x 5.00mm

(1) 要了解所有可用封装，请见数据表末尾的可订购产品附录。

典型应用电路原理图

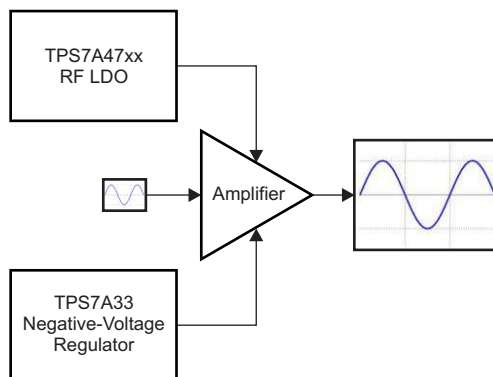

目录

1	特性	1	8	Application and Implementation	15
2	应用	1	8.1	Application Information.....	15
3	说明	1	8.2	Typical Application	18
4	修订历史记录	2	8.3	Do's and Don'ts.....	20
5	Pin Configuration and Functions	4	9	Power Supply Recommendations	21
6	Specifications	5	10	Layout	21
6.1	Absolute Maximum Ratings	5	10.1	Layout Guidelines	21
6.2	ESD Ratings	5	10.2	Layout Example	21
6.3	Recommended Operating Conditions.....	5	10.3	Thermal Performance and Heat Sink Selection....	24
6.4	Thermal Information	5	10.4	Package Mounting	25
6.5	Electrical Characteristics.....	6	11	器件和文档支持	25
6.6	Typical Characteristics.....	7	11.1	器件支持	25
7	Detailed Description	12	11.2	文档支持	25
7.1	Overview	12	11.3	商标	25
7.2	Functional Block Diagram	12	11.4	静电放电警告.....	25
7.3	Feature Description.....	12	11.5	术语表	25
7.4	Device Functional Modes.....	14	12	机械封装和可订购信息	25

4 修订历史记录

NOTE: Page numbers for previous revisions may differ from page numbers in the current version.

Changes from Revision C (February 2013) to Revision D	Page
• 已添加 ESD 额定值表, 特性描述部分, 器件功能模式, 应用和实施部分, 电源相关建议部分, 布局部分, 器件和文档支持部分以及机械、封装和可订购信息部分	1
• 已更正数据表标题以显示精确的最大输出电流; 将“-1A”更改为“1A”	1
• 已更改 首页图并已删除声明 RGW 封装处于产品预览状态的注释.....	1
• Changed <i>Pin Configuration and Functions</i> section; updated table format and deleted footnote about RGW product-preview status.....	4
• Deleted footnote from Pin Functions table indicating RGW product-preview status.....	4
• Deleted footnote (2) from <i>Absolute Maximum Ratings</i> table.....	5
• Deleted note from <i>Thermal Information</i> table stating that RGW package was product preview	5
• Corrected condition values for Figure 23	9
• Corrected condition values for Figure 24	9
• Corrected condition values and trace indicators for Figure 25	10
• Corrected condition values and trace indicators for Figure 26	10
• Changed C _{SS} value from 1 μF to 10 nF in Figure 27	10
• Deleted <i>Parametric Measurement Information</i> section	12
• Revised <i>Functional Block Diagram</i>	12
• Changed first paragraph of <i>Adjustable Operation</i> section stating the device output voltage range	15
• Changed Equation 2 for clarity	15
• Changed last sentence of <i>Capacitor Recommendations</i> section	16
• Changed noise reduction capacitor value from 1 μF to 10 nF in first paragraph of <i>Power-Supply Rejection</i> section.	17
• Revised last paragraph of <i>Power-Supply Rejection</i> section.....	17
• Changed noise reduction capacitor value from 1 μF to 10 nF in second paragraph of <i>Output Noise</i> section.	17
• Added footnote (1) to Figure 32	18
• Changed title for Figure 41	23
• Changed title for Figure 42	23
• Changed <i>Power Dissipation</i> section title to <i>Layout Guidelines for Thermal Performance and Heat Sink Selection</i>	24

修订历史记录 (接下页)

- Revised wording in *Layout Guidelines for Thermal Performance* section for clarification 24

Changes from Revision B (March 2012) to Revision C **Page**

- 已更改 产品状态, 从混合状态更改为量产数据 1
- 已添加 最后一段至说明部分 1
- 已更改 典型应用方框图 1
- Updated [Figure 31](#) 17

Changes from Revision A (December 2011) to Revision B **Page**

- 已更改 产品状态, 从量产数据更改为混合状态 1
- 已添加 RGW 引脚图 1
- Added RGW pinout drawing to *Pin Configuration and Functions* section 4
- Added RGW and footnote 1 to Pin Functions table 4
- Added RGW column to *Thermal Information* table 5

Changes from Original (December 2011) to Revision A **Page**

- 已更改 产品状态, 从产品预览更改为量产数据 1

5 Pin Configuration and Functions

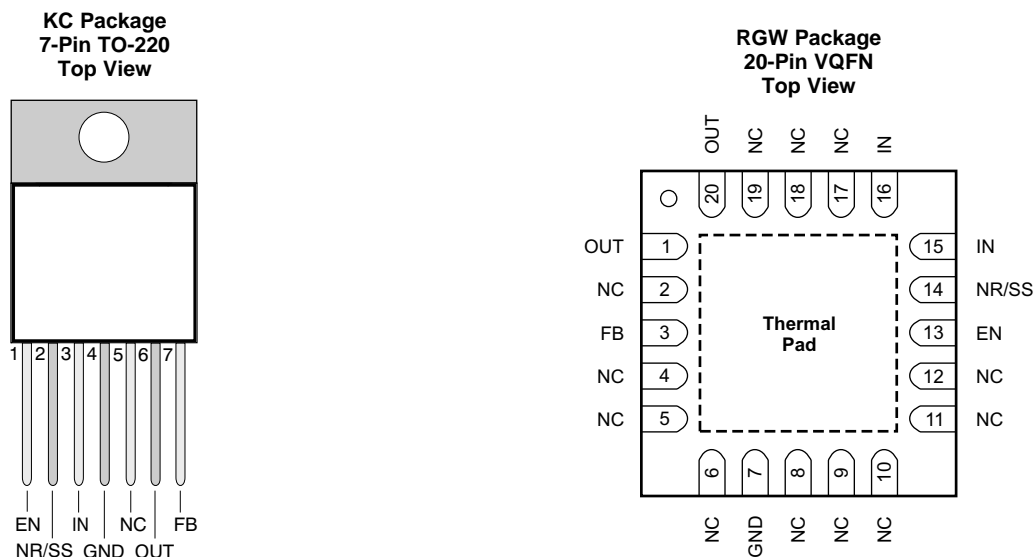

Pin Functions

NAME	PIN		I/O	DESCRIPTION
	TO-220	VQFN		
EN	1	13	I	This pin turns the regulator on or off. If $V_{EN} \geq V_{EN(+HI)}$ or $V_{EN} \leq V_{EN(-HI)}$, the regulator is enabled. If $V_{EN(+LO)} \geq V_{EN} \geq V_{EN(-LO)}$, the regulator is disabled. The EN pin can be connected to IN, if not used. $ V_{EN} \leq V_{IN} $.
FB	7	3	I	This pin is the input to the control-loop error amplifier. It is used to set the output voltage of the device. TI recommends connecting a 10-nF capacitor from FB to OUT (as close to the device as possible) to maximize AC performance.
GND	4	7	—	Ground
IN	3	15, 16	I	Input supply. A capacitor greater than or equal to 10 nF must be tied from this pin to ground to assure stability. It is recommended to connect a 10- μ F capacitor from IN to GND (as close to the device as possible) to reduce circuit sensitivity to printed-circuit-board (PCB) layout, especially when long input traces or high source impedances are encountered.
NC	5	2, 4-6, 8-12, 17-19	—	This pin can be left open or tied to any voltage between GND and IN.
NR/SS	2	14	—	Noise reduction pin. A capacitor connected from this pin to GND controls the soft-start function and allows RMS noise to be reduced to very low levels. TI recommends connecting a 1- μ F capacitor from NR/SS to GND (as close to the device as possible) to filter the noise generated by the internal bandgap and maximize ac performance.
OUT	6	1, 20	O	Regulator output. A capacitor greater than or equal to 10 μ F must be tied from this pin to ground to assure stability. TI recommends connecting a 47- μ F ceramic capacitor from OUT to GND (as close to the device as possible) to maximize ac performance.
Thermal Pad	Tab	—	—	Connect the thermal pad to a large-area ground plane. The thermal pad is internally connected to GND. An external heatsink can be installed to provide additional thermal performance.

6 Specifications

6.1 Absolute Maximum Ratings

over operating free-air temperature range (unless otherwise noted) ⁽¹⁾

		MIN	MAX	UNIT
Voltage	IN pin to GND pin	–36	0.3	V
	OUT pin to GND pin	–33	0.3	
	OUT pin to IN pin	–0.3	36	
	FB pin to GND pin	–2	0.3	
	FB pin to IN pin	–0.3	36	
	EN pin to GND pin	–36	10	
	NR/SS pin to IN pin	–0.3	36	
	NR/SS pin to GND pin	–2	0.3	
Current	Peak output	Internally limited		
Temperature	Operating virtual junction, T_J	–40	150	°C
	Storage temperature, T_{stg}	–65	150	

(1) Stresses beyond those listed under *Absolute Maximum Ratings* may cause permanent damage to the device. These are stress ratings only, which do not imply functional operation of the device at these or any other conditions beyond those indicated under *Recommended Operating Conditions*. Exposure to absolute-maximum-rated conditions for extended periods may affect device reliability.

6.2 ESD Ratings

		VALUE	UNIT
$V_{(ESD)}$	Electrostatic discharge	Human body model (HBM), per ANSI/ESDA/JEDEC JS-001, all pins ⁽¹⁾	±1000
		Charged device model (CDM), per JEDEC specification JESD22-C101, all pins ⁽²⁾	±500

(1) JEDEC document JEP155 states that 500-V HBM allows safe manufacturing with a standard ESD control process.

(2) JEDEC document JEP157 states that 250-V CDM allows safe manufacturing with a standard ESD control process.

6.3 Recommended Operating Conditions

over operating free-air temperature range (unless otherwise noted)

		MIN	NOM	MAX	UNIT
V_{IN}	Input supply voltage	–35		–3	V
V_{EN}	Enable supply voltage	V_{IN}		10	V
V_{OUT}	Output voltage	–33.2		V_{REF}	V
I_{OUT}	Output current	0		1	A
$R_2^{(1)}$	R_2 is the lower feedback resistor			240	k Ω
C_{IN}	Input capacitor	10	47		μ F
C_{OUT}	Output capacitor	10	47		μ F
C_{NR}	Noise reduction capacitor		1		μ F
C_{FF}	Feed-forward capacitor		10		nF
T_J	Operating junction temperature	–40		125	°C

(1) This condition helps ensure stability at no load.

6.4 Thermal Information

THERMAL METRIC ⁽¹⁾		TPS7A33		UNIT
		KC (TO-220)	RGW (VQFN)	
		7 PINS	20 PINS	
$R_{\theta JA}$	Junction-to-ambient thermal resistance	31.2	33.7	°C/W
$R_{\theta JC(top)}$	Junction-to-case(top) thermal resistance	40	30.4	
$R_{\theta JB}$	Junction-to-board thermal resistance	17.4	12.5	
Ψ_{JT}	Junction-to-top characterization parameter	6.4	0.4	
Ψ_{JB}	Junction-to-board characterization parameter	17.2	12.5	
$R_{\theta JC(bot)}$	Junction-to-case(bottom) thermal resistance	0.8	2.4	

(1) For more information about traditional and new thermal metrics, see the *IC Package Thermal Metrics* application report, [SPRA953](#).

6.5 Electrical Characteristics

At $-40^{\circ}\text{C} \leq T_J \leq 125^{\circ}\text{C}$, $|V_{IN}| = |V_{OUT(nom)}| + 1\text{ V}$ or $|V_{IN}| = 3\text{ V}$ (whichever is greater), $V_{EN} = V_{IN}$, $I_{OUT} = 1\text{ mA}$, $C_{IN} = 10\text{ }\mu\text{F}$, $C_{OUT} = 10\text{ }\mu\text{F}$, $C_{NR/SS} = 0\text{ nF}$, and FB tied to OUT, unless otherwise noted.⁽¹⁾

PARAMETER		TEST CONDITIONS	MIN	TYP	MAX	UNIT
V_{IN}	Input voltage		-35		-3	V
V_{REF}	Internal reference	$T_J = 25^{\circ}\text{C}$, $V_{FB} = V_{REF}$	-1.192	-1.175	-1.157	V
V_{UVLO}	Undervoltage lockout threshold			-2		V
V_{OUT}	Output voltage range ⁽²⁾	$ V_{IN} \geq V_{OUT(nom)} + 1\text{ V}$	-33.2		V_{REF}	V
	Nominal accuracy	$T_J = 25^{\circ}\text{C}$, $ V_{IN} = V_{OUT(nom)} + 0.5\text{ V}$	-1.5		1.5	% V_{OUT}
	Overall accuracy	$5\text{ V} \leq V_{IN} \leq 35\text{ V}$ $1\text{ mA} \leq I_{OUT} \leq 1\text{ A}$		± 1		
$ V_{OUT(nom)} + 1\text{ V} \leq V_{IN} \leq 35\text{ V}$ $1\text{ mA} \leq I_{OUT} \leq 1\text{ A}$		-2.5		2.5		
$\Delta V_{OUT(\Delta V)}$	Line regulation	$ V_{OUT(nom)} + 1\text{ V} \leq V_{IN} \leq 35\text{ V}$		0.14		% V_{OUT}
$\Delta V_{OUT(\Delta I)}$	Load regulation	$1\text{ mA} \leq I_{OUT} \leq 1\text{ A}$		0.4		% V_{OUT}
$ V_{DO} $	Dropout voltage	$V_{IN} = 95\% V_{OUT(nom)}$, $I_{OUT} = 500\text{ mA}$		290		mV
		$V_{IN} = 95\% V_{OUT(nom)}$, $I_{OUT} = 1\text{ A}$		325	800	
I_{CL}	Current limit	$V_{OUT} = 90\% V_{OUT(nom)}$		1900		mA
I_{GND}	Ground current	$I_{OUT} = 0\text{ mA}$		210	350	μA
		$I_{OUT} = 500\text{ mA}$		5		mA
$ I_{SHDN} $	Shutdown supply current	$V_{EN} = +0.4\text{ V}$		1	3	μA
		$V_{EN} = -0.4\text{ V}$		1	3	
I_{FB}	Feedback current ⁽³⁾			14	100	nA
$ I_{EN} $	Enable current	$V_{EN} = V_{IN} = V_{OUT(nom)} + 1\text{ V}$		0.48	1	μA
		$V_{IN} = V_{EN} = -35\text{ V}$		0.51	1	
		$V_{IN} = -35\text{ V}$, $V_{EN} = +10\text{ V}$		0.5	1	
$V_{EN(+HI)}$	Positive enable high-level voltage		2		10	V
$V_{EN(+LO)}$	Positive enable low-level voltage		0		0.4	V
$V_{EN(-HI)}$	Negative enable high-level voltage		V_{IN}		-2	V
$V_{EN(-LO)}$	Negative enable low-level voltage		-0.4		0	V
V_n	Output noise voltage	$V_{IN} = -3\text{ V}$, $V_{OUT(nom)} = V_{REF}$, $C_{OUT} = 22\text{ }\mu\text{F}$, $C_{NR/SS} = 10\text{ nF}$, $BW = 10\text{ Hz to }100\text{ kHz}$		16		μV_{RMS}
PSRR	Power-supply rejection ratio	$V_{IN} = -6.2\text{ V}$, $V_{OUT(nom)} = -5\text{ V}$, $C_{OUT} = 22\text{ }\mu\text{F}$, $C_{NR/SS} = 10\text{ nF}$, C_{FF} ⁽⁴⁾ = 10 nF , $f = 10\text{ kHz}$		72		dB
T_{sd}	Thermal shutdown temperature	Shutdown, temperature increasing		170		$^{\circ}\text{C}$
		Reset, temperature decreasing		150		$^{\circ}\text{C}$
T_J	Operating junction temperature		-40		125	$^{\circ}\text{C}$

(1) At operating conditions, $V_{IN} \leq 0\text{ V}$, $V_{OUT(nom)} \leq V_{REF} \leq 0\text{ V}$. At regulation, $V_{IN} \leq V_{OUT(nom)} - |V_{DO}|$. $I_{OUT} > 0$ flows from OUT to IN.

(2) To ensure stability at no load conditions, a current from the feedback resistive network equal to or greater than $5\text{ }\mu\text{A}$ is required.

(3) $I_{FB} > 0$ flows into the device.

(4) C_{FF} refers to a feed-forward capacitor connected between the FB and OUT pins.

6.6 Typical Characteristics

At $-40^{\circ}\text{C} \leq T_J \leq 125^{\circ}\text{C}$, $|V_{IN}| = |V_{OUT(nom)}| + 1\text{ V}$ or $|V_{IN}| = 3\text{ V}$ (whichever is greater), $V_{EN} = V_{IN}$, $I_{OUT} = 1\text{ mA}$, $C_{IN} = 22\text{ }\mu\text{F}$, $C_{OUT} = 22\text{ }\mu\text{F}$, $C_{NR/SS} = 0\text{ nF}$, and the FB pin tied to OUT, unless otherwise noted.

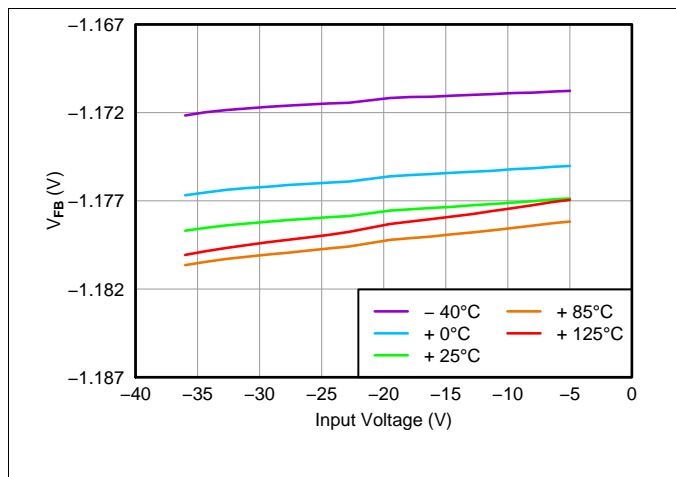

Figure 1. Feedback Voltage vs Input Voltage

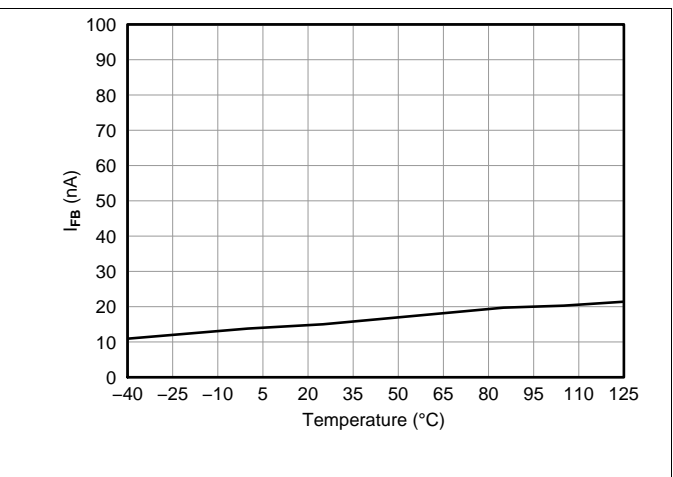

Figure 2. Feedback Current vs Temperature

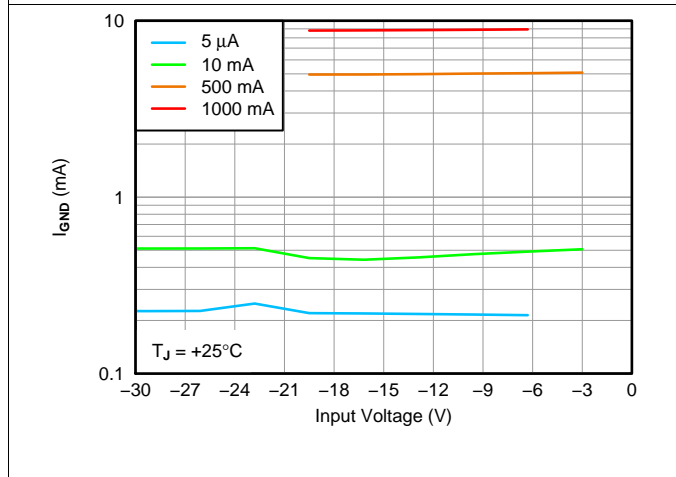

Figure 3. Ground Current vs Input Voltage

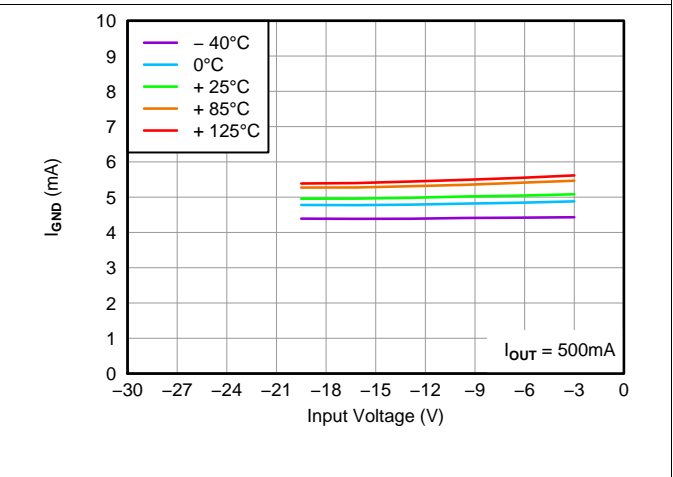

Figure 4. Ground Current vs Input Voltage

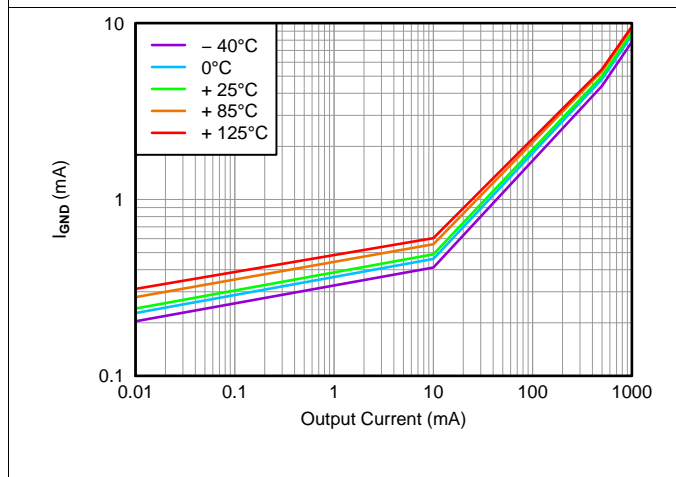

Figure 5. Ground Current vs Output Current

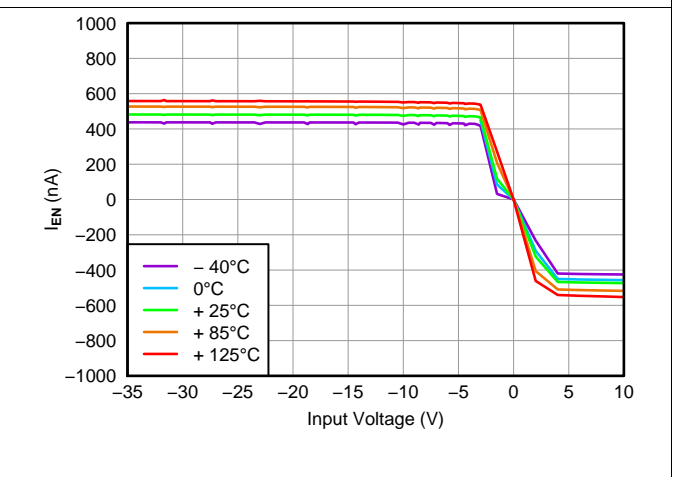

Figure 6. Enable Current vs Enable Voltage

Typical Characteristics (continued)

At $-40^{\circ}\text{C} \leq T_J \leq 125^{\circ}\text{C}$, $|V_{IN}| = |V_{OUT(nom)}| + 1\text{ V}$ or $|V_{IN}| = 3\text{ V}$ (whichever is greater), $V_{EN} = V_{IN}$, $I_{OUT} = 1\text{ mA}$, $C_{IN} = 22\text{ }\mu\text{F}$, $C_{OUT} = 22\text{ }\mu\text{F}$, $C_{NR/SS} = 0\text{ nF}$, and the FB pin tied to OUT, unless otherwise noted.

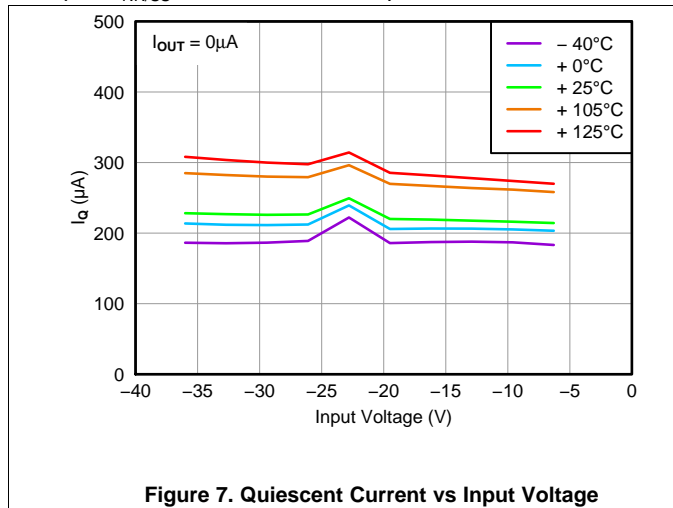

Figure 7. Quiescent Current vs Input Voltage

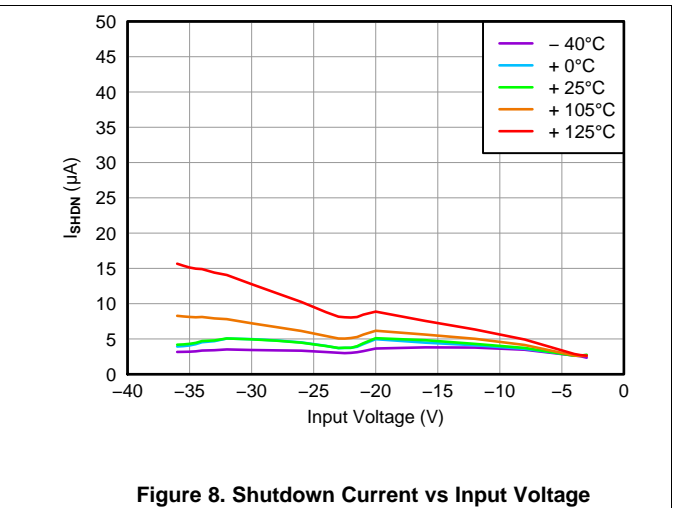

Figure 8. Shutdown Current vs Input Voltage

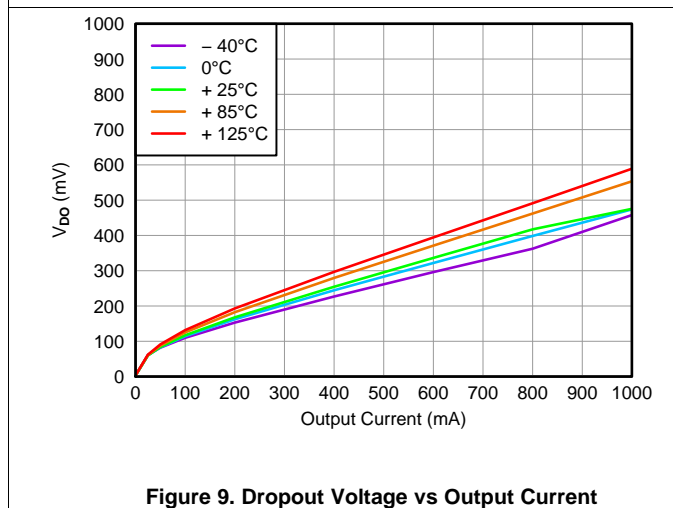

Figure 9. Dropout Voltage vs Output Current

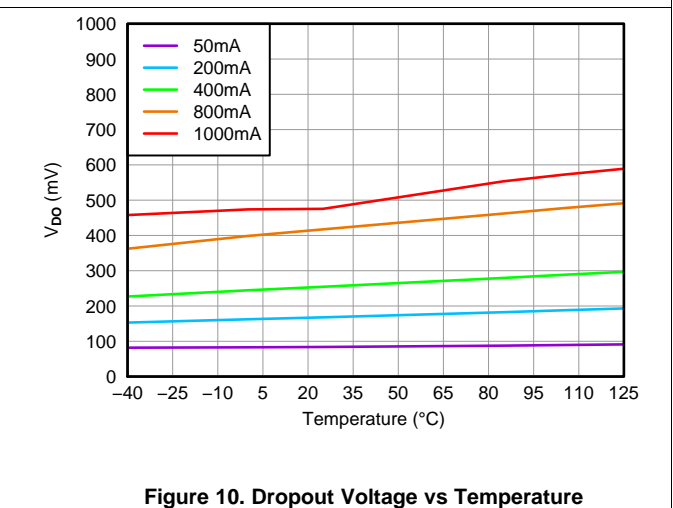

Figure 10. Dropout Voltage vs Temperature

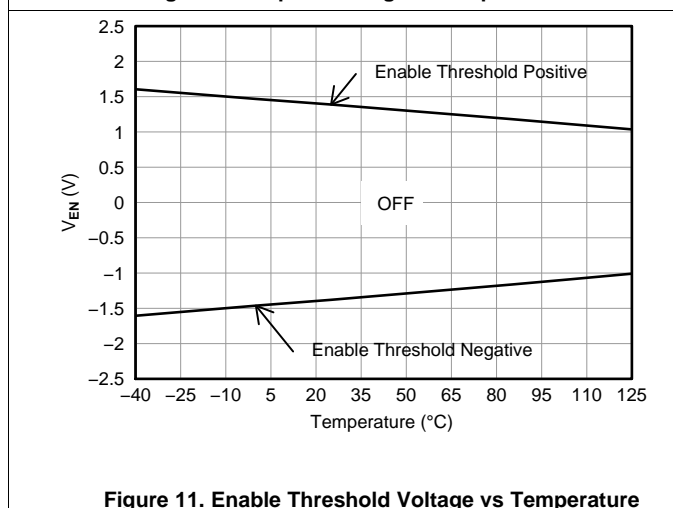

Figure 11. Enable Threshold Voltage vs Temperature

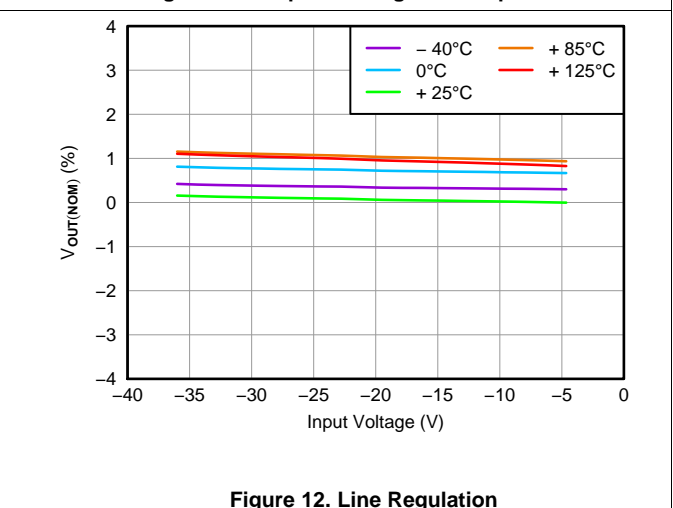

Figure 12. Line Regulation

Typical Characteristics (continued)

At $-40^{\circ}\text{C} \leq T_J \leq 125^{\circ}\text{C}$, $|V_{IN}| = |V_{OUT(nom)}| + 1\text{ V}$ or $|V_{IN}| = 3\text{ V}$ (whichever is greater), $V_{EN} = V_{IN}$, $I_{OUT} = 1\text{ mA}$, $C_{IN} = 22\text{ }\mu\text{F}$, $C_{OUT} = 22\text{ }\mu\text{F}$, $C_{NR/SS} = 0\text{ nF}$, and the FB pin tied to OUT, unless otherwise noted.

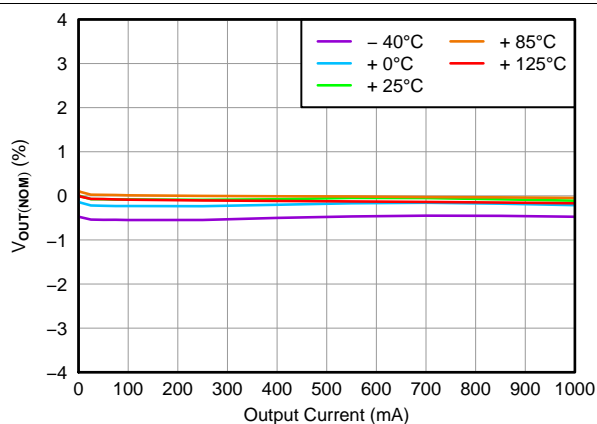

Figure 13. Load Regulation

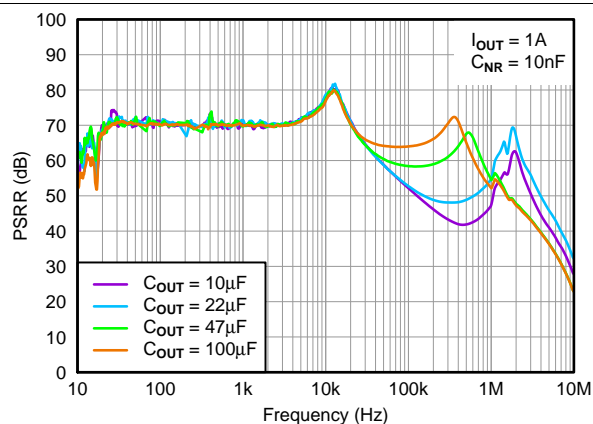

Figure 14. Power-Supply Rejection Ratio vs C_{OUT}

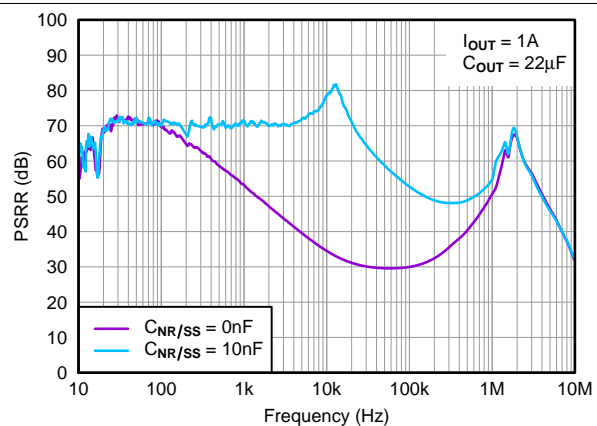

Figure 15. Power-Supply Rejection Ratio vs C_{NR/SS}

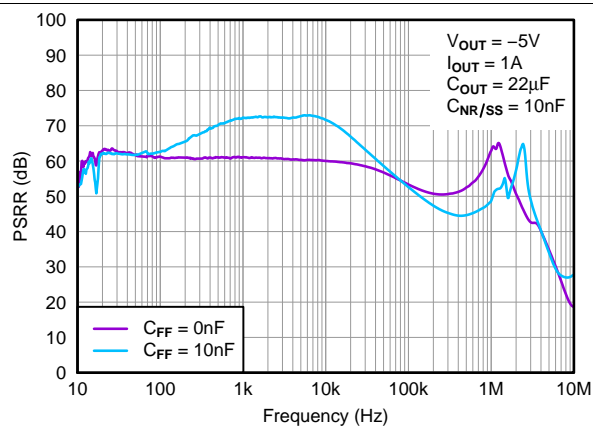

Figure 16. Power-Supply Rejection Ratio vs C_{FF}

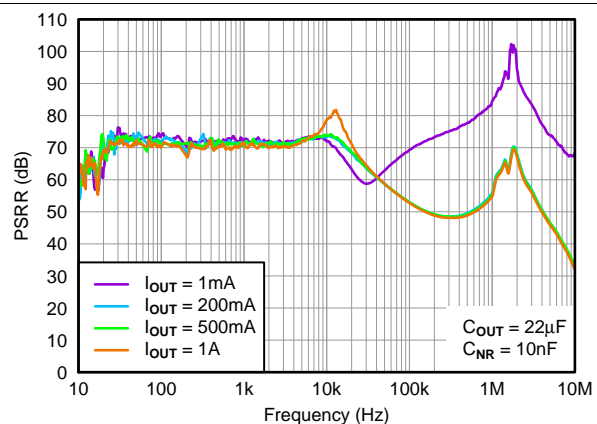

Figure 17. Power-Supply Rejection Ratio vs I_{OUT}

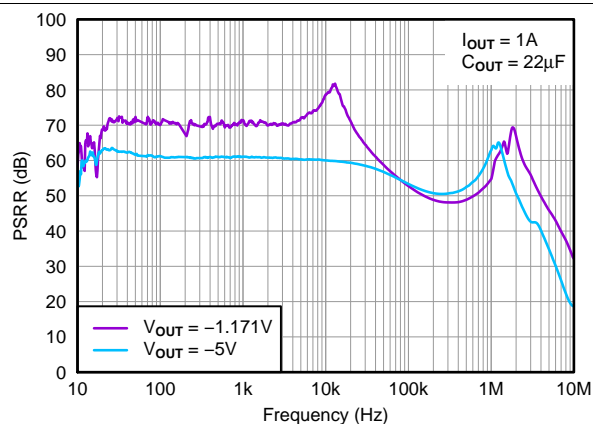

Figure 18. Power-Supply Rejection Ratio vs V_{OUT}

Typical Characteristics (continued)

At $-40^{\circ}\text{C} \leq T_J \leq 125^{\circ}\text{C}$, $|V_{IN}| = |V_{OUT(nom)}| + 1\text{ V}$ or $|V_{IN}| = 3\text{ V}$ (whichever is greater), $V_{EN} = V_{IN}$, $I_{OUT} = 1\text{ mA}$, $C_{IN} = 22\text{ }\mu\text{F}$, $C_{OUT} = 22\text{ }\mu\text{F}$, $C_{NR/SS} = 0\text{ nF}$, and the FB pin tied to OUT, unless otherwise noted.

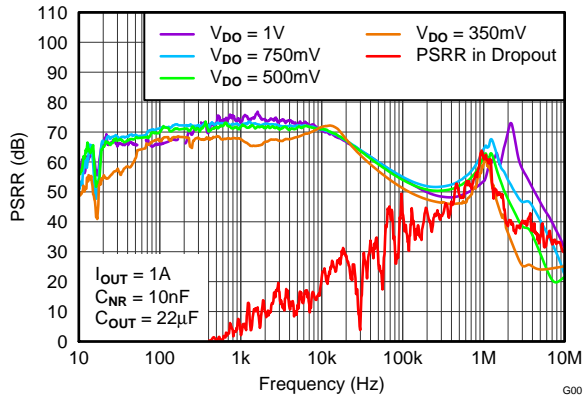

Figure 19. Power-Supply Rejection Ratio vs V_{DO}

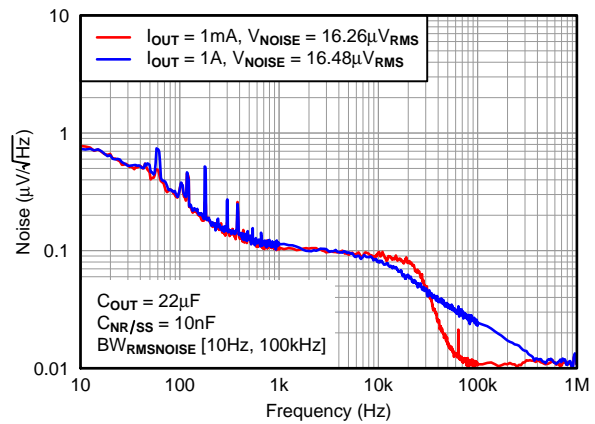

Figure 20. Output Spectral Noise Density vs Output Current

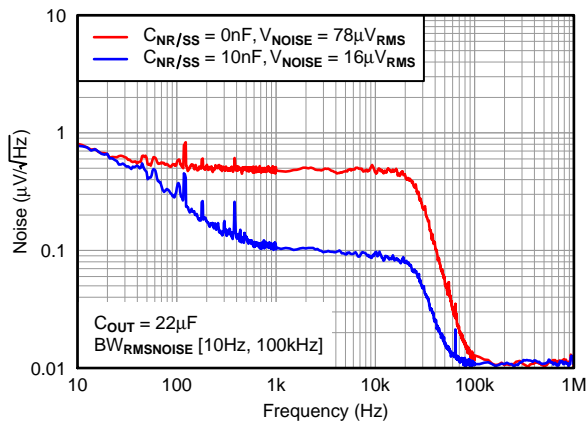

Figure 21. Output Spectral Noise Density vs $C_{NR/SS}$

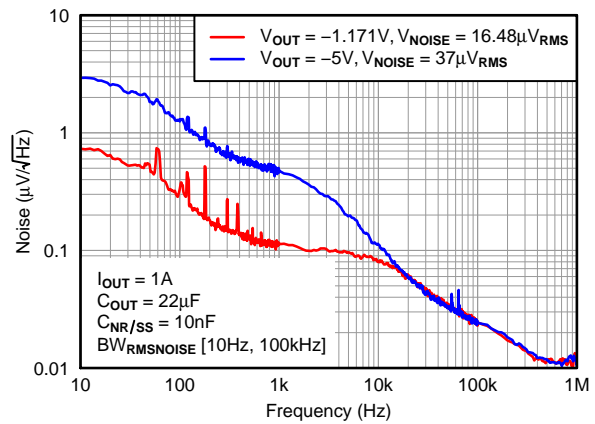

Figure 22. Output Spectral Noise Density vs $V_{OUT(nom)}$

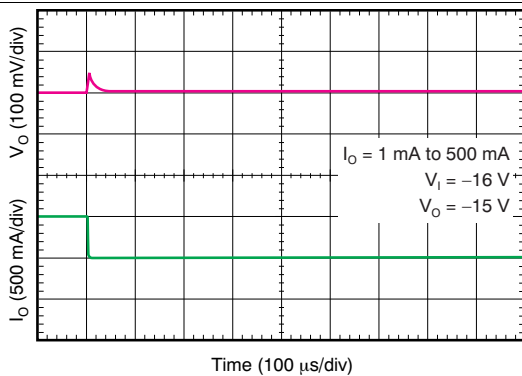

Figure 23. Load Transient

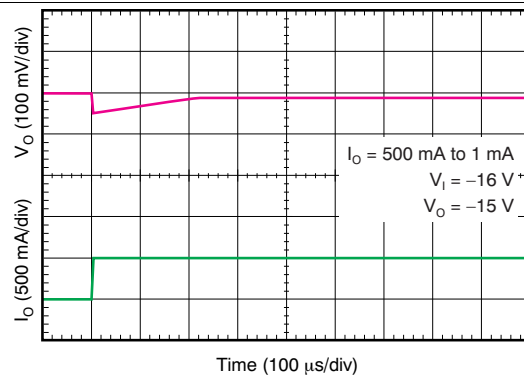

Figure 24. Load Transient

Typical Characteristics (continued)

At $-40^{\circ}\text{C} \leq T_J \leq 125^{\circ}\text{C}$, $|V_{IN}| = |V_{OUT(nom)}| + 1\text{ V}$ or $|V_{IN}| = 3\text{ V}$ (whichever is greater), $V_{EN} = V_{IN}$, $I_{OUT} = 1\text{ mA}$, $C_{IN} = 22\text{ }\mu\text{F}$, $C_{OUT} = 22\text{ }\mu\text{F}$, $C_{NR/SS} = 0\text{ nF}$, and the FB pin tied to OUT, unless otherwise noted.

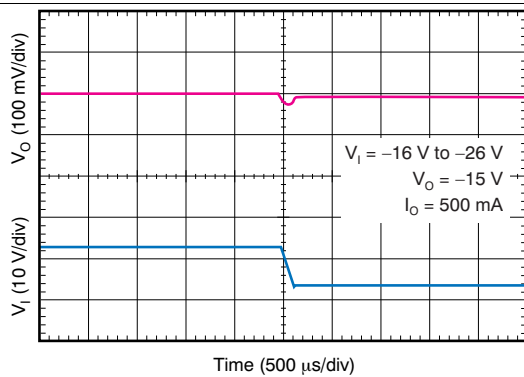

Figure 25. Line Transient

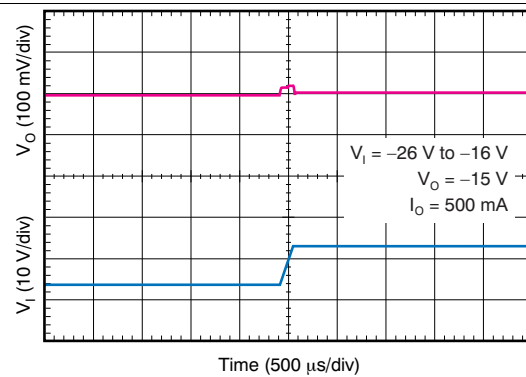

Figure 26. Line Transient

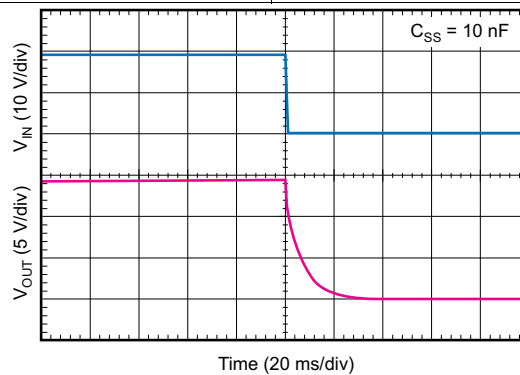

Figure 27. Capacitor-Programmable Soft-Start

7 Detailed Description

7.1 Overview

The TPS7A33 belongs to a family of new-generation linear regulators that use an innovative bipolar process to achieve ultralow-noise and very high PSRR levels at a wide input voltage and current range. These features, combined with the external heatsink-capable, high thermal performance TO-220 package, make this device ideal for high-performance analog applications.

7.2 Functional Block Diagram

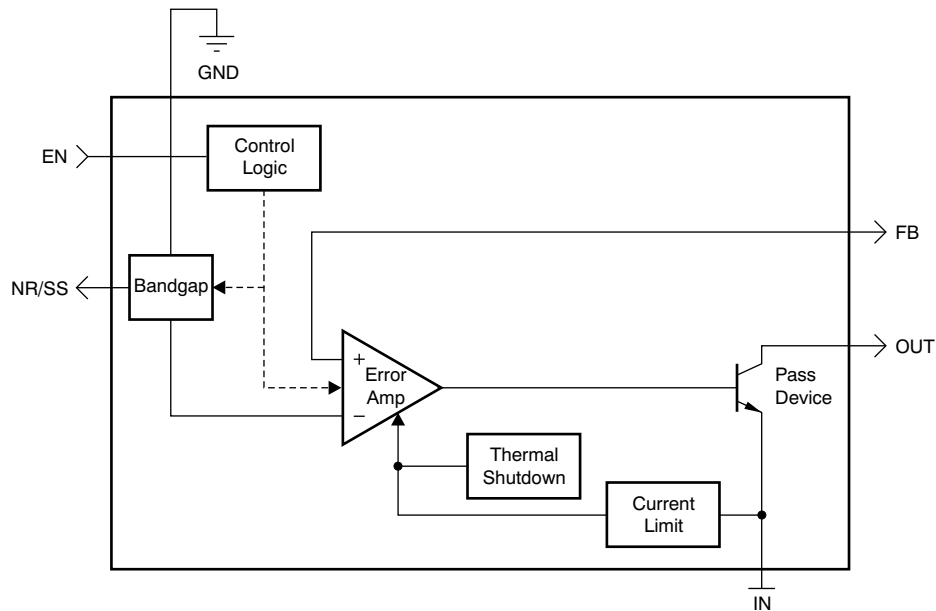

7.3 Feature Description

7.3.1 Internal Current Limit

The fixed internal current limit of the TPS7A33xx family helps protect the regulator during fault conditions. The maximum amount of current the device can source is the current limit (1.9 A, typical), and it is largely independent of output voltage. For reliable operation, do not operate the device in current limit for extended periods of time.

Feature Description (continued)

7.3.2 Enable Pin Operation

The TPS7A33 provides a dual-polarity enable pin (EN) that turns on the regulator when $|V_{EN}| > 2\text{ V}$, whether the voltage is positive or negative, as shown in Figure 28.

This functionality allows for different system power management topologies; for example:

- Connecting the EN pin directly to a negative voltage, such as V_{IN} , or
- Connecting the EN pin directly to a positive voltage, such as the output of digital logic circuitry.

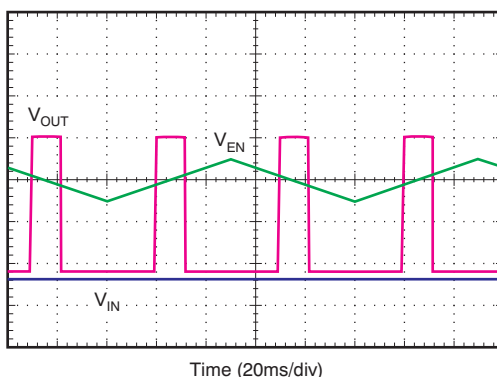

Figure 28. Enable Pin Positive and Negative Threshold

7.3.3 Programmable Soft-Start

The NR capacitor also acts as a soft-start capacitor to slow down the rise time of the output. The output rise time, when using an NR capacitor, is governed by Equation 1.

$$t_{SS} \text{ (ms)} = 1.2 \times C_{NR} \text{ (nF)} \quad (1)$$

In Equation 1, t_{SS} is the soft-start time in milliseconds, and $C_{NR/SS}$ is the capacitance at the NR pin in nanofarads.

Figure 29 shows the start-up voltage waveforms versus $C_{NR/SS}$.

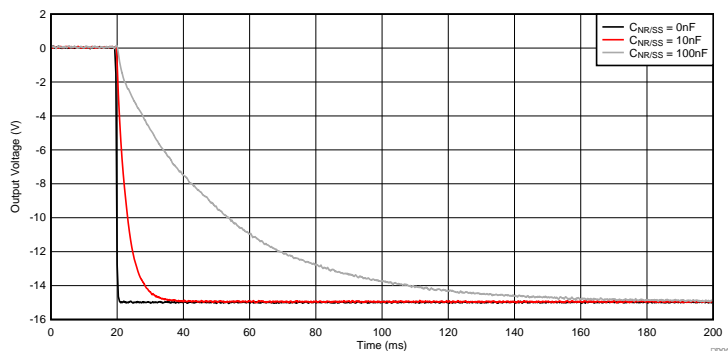

Figure 29. Start-Up vs $C_{NR/SS}$

7.3.4 Thermal Protection

Thermal protection disables the output when the junction temperature rises to approximately 170°C , allowing the device to cool. When the junction temperature cools to approximately 150°C , the output circuitry is enabled. Depending on power dissipation, thermal resistance, and ambient temperature, the thermal protection circuit may cycle on and off. This cycling limits the dissipation of the regulator, protecting it from damage as a result of overheating.

Feature Description (continued)

Any tendency to activate the thermal protection circuit indicates excessive power dissipation or an inadequate heat sink. For reliable operation, junction temperature should be limited to a maximum of 125°C. To estimate the margin of safety in a complete design (including heat sink), increase the ambient temperature until the thermal protection is triggered; use worst-case loads and signal conditions. For good reliability, thermal protection should trigger at least 35°C above the maximum expected ambient condition of your particular application. This configuration produces a worst-case junction temperature of 125°C at the highest expected ambient temperature and worst-case load.

The internal protection circuitry of the TPS7A33 has been designed to protect against overload conditions. It was not intended to replace proper heatsinking. Continuously running the TPS7A33 into thermal shutdown degrades device reliability.

7.4 Device Functional Modes

7.4.1 Normal Operation

The device regulates to the nominal output voltage under the following conditions:

- The input voltage has previously exceeded the UVLO rising voltage and has not decreased below the UVLO falling threshold.
- The input voltage is greater than the nominal output voltage added to the dropout voltage.
- $|V_{EN}| > |V_{(HI)}|$
- The output current is less than the current limit.
- The device junction temperature is less than the maximum specified junction temperature.

7.4.2 Dropout Operation

If the input voltage magnitude is lower than the nominal output voltage magnitude plus the specified dropout voltage magnitude, but all other conditions are met for normal operation, the device operates in dropout mode. In this condition, the output voltage magnitude is the same as the input voltage magnitude minus the dropout voltage magnitude. The transient performance of the device is significantly degraded because the pass device (as a bipolar junction transistor, or BJT) is in saturation and no longer controls the current through the LDO. Line or load transients in dropout can result in large output voltage deviations.

7.4.3 Disabled

The device is disabled under the following conditions:

- $|V_{EN}| < |V_{(HI)}|$
- The device junction temperature is greater than the thermal shutdown temperature.

Table 1 shows the conditions that lead to the different modes of operation.

Table 1. Device Functional Mode Comparison

OPERATING MODE	PARAMETER			
	V_{IN}	V_{EN}	I_{OUT}	T_J
Normal mode	$ V_{IN} > \{ V_{OUT(nom)} + V_{DO} , V_{IN(min)} \}$	$ V_{EN} > V_{(HI)} $	$I_{OUT} < I_{CL}$	$T_J < 125^\circ\text{C}$
Dropout mode	$ V_{IN(min)} < V_{IN} < V_{OUT(nom)} + V_{DO} $	$ V_{EN} > V_{(HI)} $	—	$T_J < 125^\circ\text{C}$
Disabled mode (any true condition disables the device)	—	$ V_{EN} < V_{(HI)} $	—	$T_J > 165^\circ\text{C}$

8 Application and Implementation

NOTE

Information in the following applications sections is not part of the TI component specification, and TI does not warrant its accuracy or completeness. TI's customers are responsible for determining suitability of components for their purposes. Customers should validate and test their design implementation to confirm system functionality.

8.1 Application Information

8.1.1 Adjustable Operation

The TPS7A3301 has an output voltage range of $-V_{REF}$ to -33 V. The nominal output voltage of the device is set by two external resistors, as shown in [Figure 32](#).

R_1 and R_2 can be calculated for any output voltage range using [Equation 2](#). To ensure stability under no-load conditions at $V_{OUT} > V_{REF}$, this resistive network must provide a current equal to or greater than $5 \mu\text{A}$.

$$R_1 = R_2 \left(\frac{V_{OUT}}{V_{REF}} - 1 \right), \text{ where } \frac{|V_{REF(max)}|}{R_2} > 5 \mu\text{A} \quad (2)$$

If greater voltage accuracy is required, consider the output voltage offset contributions because of the feedback pin current and use 0.1%-tolerance resistors.

[Table 2](#) shows the resistor combinations to achieve a few of the most common rails using commercially available, 0.1%-tolerance resistors to maximize nominal voltage accuracy while adhering to the formula shown in [Equation 2](#).

Table 2. Suggested Resistors For Common Voltage Rails

V_{OUT} (V)	R_1	R_2 (k Ω)	$V_{OUT}/(R_1+R_2)$ (μA)	NOMINAL ACCURACY
-1.171	0 Ω	∞	0	$\pm 1.5\%$
-1.8	76.8 k Ω	143	8.18	$\pm(1.5\% + 0.08\%)$
-3.3	200 k Ω	110	10.64	$\pm(1.5\% + 0.13\%)$
-5	332 k Ω	102	11.48	$\pm(1.5\% + 0.5\%)$
-10	1.62 M Ω	215	5.44	$\pm(1.5\% + 0.23\%)$
-12	1.5 M Ω	162	7.22	$\pm(1.5\% + 0.29\%)$
-15	1.24 M Ω	105	11.15	$\pm(1.5\% + 0.18\%)$
-18	3.09 M Ω	215	5.44	$\pm(1.5\% + 0.19\%)$
-24	1.15 M Ω	59	19.84	$\pm(1.5\% + 0.21\%)$

8.1.2 Capacitor Recommendations

Low equivalent series resistance (ESR) capacitors should be used for the input, output, noise reduction, and bypass capacitors. Ceramic capacitors with X7R and X5R dielectrics are preferred. These dielectrics offer more stable characteristics. Ceramic X7R capacitors offer improved overtemperature performance, while ceramic X5R capacitors are the most cost-effective and are available in higher values.

NOTE

High-ESR capacitors may degrade PSRR and affect stability.

8.1.3 Input and Output Capacitor Requirements

The TPS7A33 family of negative, high-voltage linear regulators achieve stability with a minimum input and output capacitance of 10 μF ; however, TI highly recommends using a 47- μF capacitor to maximize AC performance.

8.1.4 Noise Reduction and Feed-Forward Capacitor Requirements

Although the noise-reduction ($C_{\text{NR/SS}}$) and feed-forward (C_{FF}) capacitors are not needed to achieve stability, TI highly recommends using a 10-nF feed-forward capacitor and a 1- μF noise-reduction capacitor to minimize noise and maximize AC performance.

The feed-forward capacitor can also provide a soft-start effect, as detailed in the application note, *Pros and Cons of Using a Feed-Forward Capacitor with a Low Dropout Regulator*, [SBVA042](#) (available for download from the TI website). [Figure 30](#) shows device start-up with no $C_{\text{NR/SS}}$, $C_{\text{FF}} = 10 \text{ nF}$, $V_{\text{IN}} = -16 \text{ V}$, and $V_{\text{OUT}} = -15 \text{ V}$.

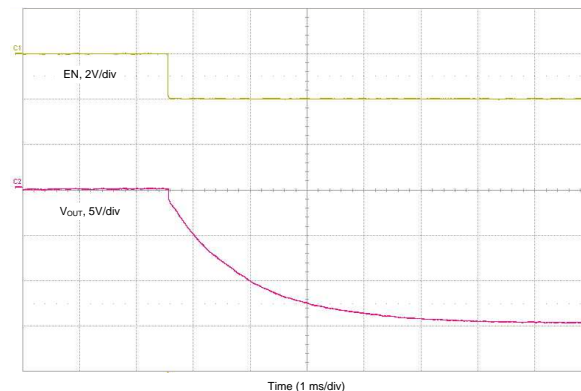

Figure 30. Start-up With a Feed-Forward Capacitor

8.1.5 Post DC-DC Converter Filtering

Most of the time, the voltage rails available in a system do not match the voltage specifications demanded by one or more of its circuits; these rails must be stepped up or down, depending on specific voltage requirements.

DC-DC converters are the preferred solution to stepping up or down a voltage rail when current consumption is not negligible. These devices offer high efficiency with minimum heat generation, but they have one primary disadvantage: they introduce a high-frequency component, and the associated harmonics, on top of the DC output signal.

If not filtered properly, this high-frequency component degrades analog circuitry performance, and reduces overall system accuracy and precision.

The TPS7A33 offers a wide-bandwidth, very-high power-supply rejection ratio (PSRR). This specification makes it ideal for post DC-DC converter filtering, as shown in [Figure 31](#). TI highly recommends using the maximum performance schematic shown in [Figure 32](#). Also, verify that the fundamental frequency (and its first harmonic, if possible) is within the bandwidth of the regulator PSRR, shown in [Figure 16](#).

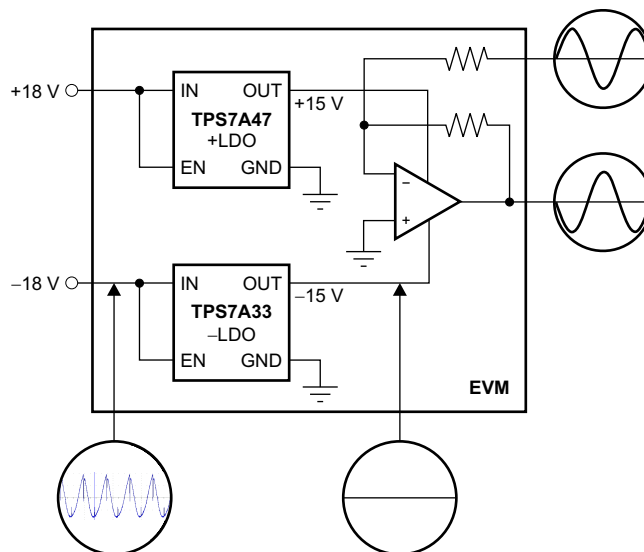

Figure 31. Post DC-DC Converter Regulation to High-Performance Analog Circuitry

8.1.6 Audio Applications

Audio applications are extremely sensitive to any distortion and noise in the audio band from 20 Hz to 20 kHz. This stringent requirement demands clean voltage rails to power critical high-performance audio systems.

The very high power-supply rejection ratio (> 60 dB) and low noise at the audio band of the TPS7A33 maximize performance for audio applications; see [Figure 16](#).

8.1.7 Maximum AC Performance

To maximize noise and PSRR performance, TI recommends including 47- μ F or higher input and output capacitors, 100-nF noise-reduction capacitors, and 10-nF feed-forward capacitors, as shown in [Figure 32](#). The solution shown delivers minimum noise levels of 16 μ V_{RMS} and power-supply rejection levels above 55 dB from 10 Hz to 1 MHz; see [Figure 19](#).

8.1.8 Power-Supply Rejection

The 10-nF noise-reduction capacitor greatly improves TPS7A33 power-supply rejection, achieving up to 10 dB of additional power-supply rejection for frequencies between 140 Hz and 500 kHz.

Additionally, AC performance can be maximized by adding a 10-nF feed-forward capacitor (C_{FF}) from the FB pin to the OUT pin. This capacitor greatly improves power-supply rejection at lower frequencies, for the band from 100 Hz to 100 kHz; see [Figure 15](#).

The high power-supply rejection of the TPS7A33 makes it a good choice for powering high-performance analog circuitry.

8.1.9 Output Noise

The TPS7A33 provides low output noise when a noise-reduction capacitor ($C_{NR/SS}$) is used.

The noise-reduction capacitor serves as a filter for the internal reference. By using a 10-nF noise reduction capacitor, the output noise is reduced by almost 80% (from 80 μ V_{RMS} to 17 μ V_{RMS}); see [Figure 21](#).

The TPS7A33 low output voltage noise makes it an ideal solution for powering noise-sensitive circuitry.

8.1.10 Transient Response

As with any regulator, increasing the size of the output capacitor reduces overshoot and undershoot magnitude, but increases duration of the transient response.

8.1.11 Power for Precision Analog

One of the primary TPS7A33 applications is to provide ultralow-noise voltage rails to high-performance analog circuitry in order to maximize system accuracy and precision.

The TPS7A33 family of negative, high-voltage linear regulators provides ultralow noise, positive and negative voltage rails to high-performance analog circuitry such as operational amplifiers, ADCs, DACs, and audio amplifiers.

Because of the ultralow noise levels at high voltages, analog circuitry with high-voltage input supplies can be used. This characteristic allows for high-performance analog solutions to optimize the voltage range, thus maximizing system accuracy.

8.2 Typical Application

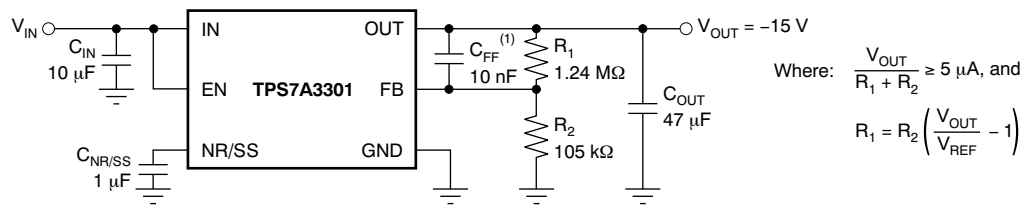

- A. Refer to application report *Pros and Cons of Using a Feed-forward Capacitor with a Low-Dropout Regulator*, SBVA042.

Figure 32. Adjustable Operation for Maximum AC Performance

8.2.1 Design Requirements

The design goals for this example are $V_{IN} = -16\text{ V}$, $V_{OUT} = -15\text{ V}$, and $I_{OUT} = 1\text{ A}$ maximum. The design must optimize transient response, and the input supply comes from a supply on the same printed-circuit board (PCB).

8.2.2 Detailed Design Procedure

The design space consists of C_{IN} , C_{OUT} , $C_{SS/NR}$, R_1 , R_2 , and the circuit shown in [Figure 32](#).

The first step when designing with a linear regulator is to examine the maximum load current along with the input and output voltage requirements to determine if the device thermal and dropout voltage requirements can be met. At 1 A, the input dropout voltage of the TPS7A33xx family is a maximum of 800 mV overtemperature; thus, the dropout headroom is sufficient for operation over both input and output voltage accuracy. Keep in mind that operating an LDO close to the dropout limit reduces AC performance, but has the benefit of reducing the power dissipation across the LDO.

The maximum power dissipated in the linear regulator is the maximum voltage drop across the pass element from the input to the output multiplied by the maximum load current. In this example, the maximum voltage drop across in the pass element is $(-16\text{ V}) - (-15\text{ V})$, giving us a $V_{DROPP} = 1\text{ V}$. The power dissipated in the pass element is calculated by taking this voltage drop multiplied by the maximum load current. For this example, the maximum power dissipated in the linear regulator is approximately 1 W, and does not include the power consumed by the V_{BIAS} rail.

Once the power dissipated in the linear regulator is known, the corresponding junction temperature rise can be calculated. To calculate the junction temperature rise above ambient, the power dissipated must be multiplied by the junction-to-ambient thermal resistance. For thermal resistance information, refer to [Thermal Information](#) and [Thermal Performance and Heat Sink Selection](#). For this example, using the RGW package, the maximum junction temperature rise is calculated to be 17.2°C. The maximum junction temperature rise is calculated by adding junction temperature rise to the maximum ambient temperature, which is 85°C. In this example, then, the maximum junction temperature is 102.2°C. The maximum junction temperature must be less than 125°C for reliable operation. Additional ground planes, added thermal vias, and air flow all combine to lower the maximum junction temperature.

To ensure an accurate output voltage, R_1 and R_2 must also be found, and the current through these resistors must be greater than 5 µA to ensure that the leakage into the device does not affect the accuracy. Using 1% resistors, and setting R_1 to 1 MΩ to minimize the current leakage while continuing to hold it above 5 µA, then use [Equation 3](#) to calculate the proper value for R_2 and the divider current.

Typical Application (continued)

$$R2 = \frac{(R1 \cdot V_{REF})}{V_O - V_{REF}} = 85 \text{ k}\Omega \quad \text{and} \quad I_{DIVIDER} = \frac{V_O}{R1 + R2} = 13.8 \text{ }\mu\text{A} \quad (3)$$

For C_{IN} , assume that the -16 V supply has some inductance, and is placed several inches away from the PCB. For this case, select a $10\text{-}\mu\text{F}$ ceramic input capacitor to ensure that the input inductance is negligible to the regulator control loop while also keeping the physical size and cost of the capacitor low because it is a standard-value capacitor. C_{OUT} is set at $20 \text{ }\mu\text{F}$ for AC performance, C_{FF} is set at 10 nF , and C_{NR} is set at 100 nF for optimal noise performance and to minimize the size of the external capacitor.

8.2.3 Application Curves

Figure 33 and Figure 34 show typical application performance for PSRR and spectral noise density, respectively, versus $C_{NR/SS}$ with C_{FF} .

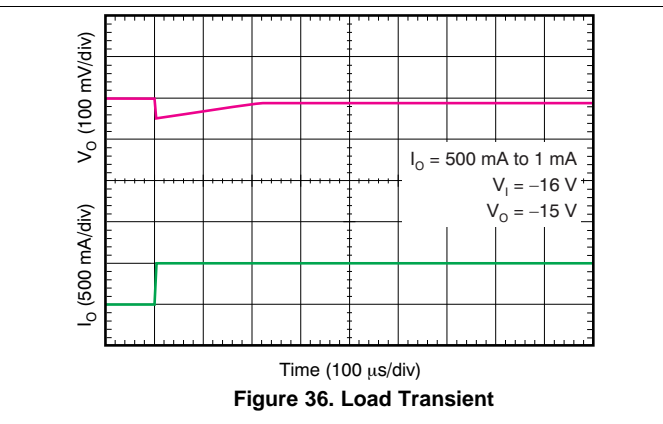
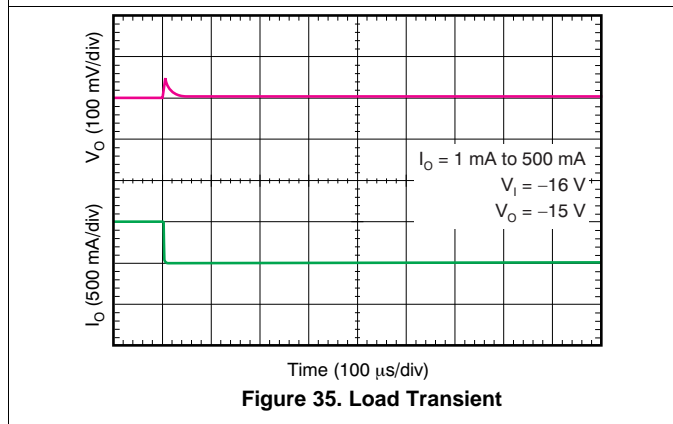
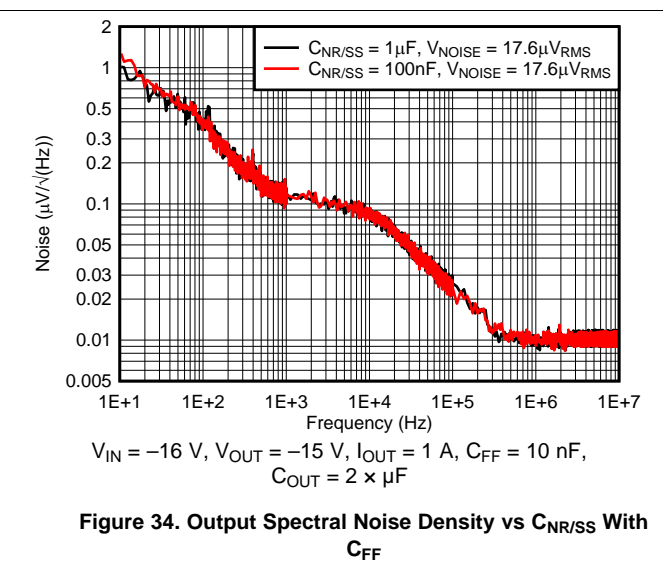
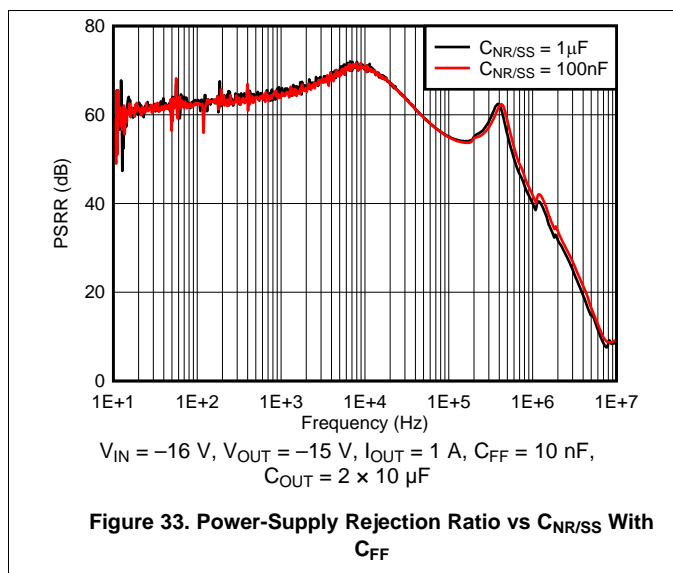

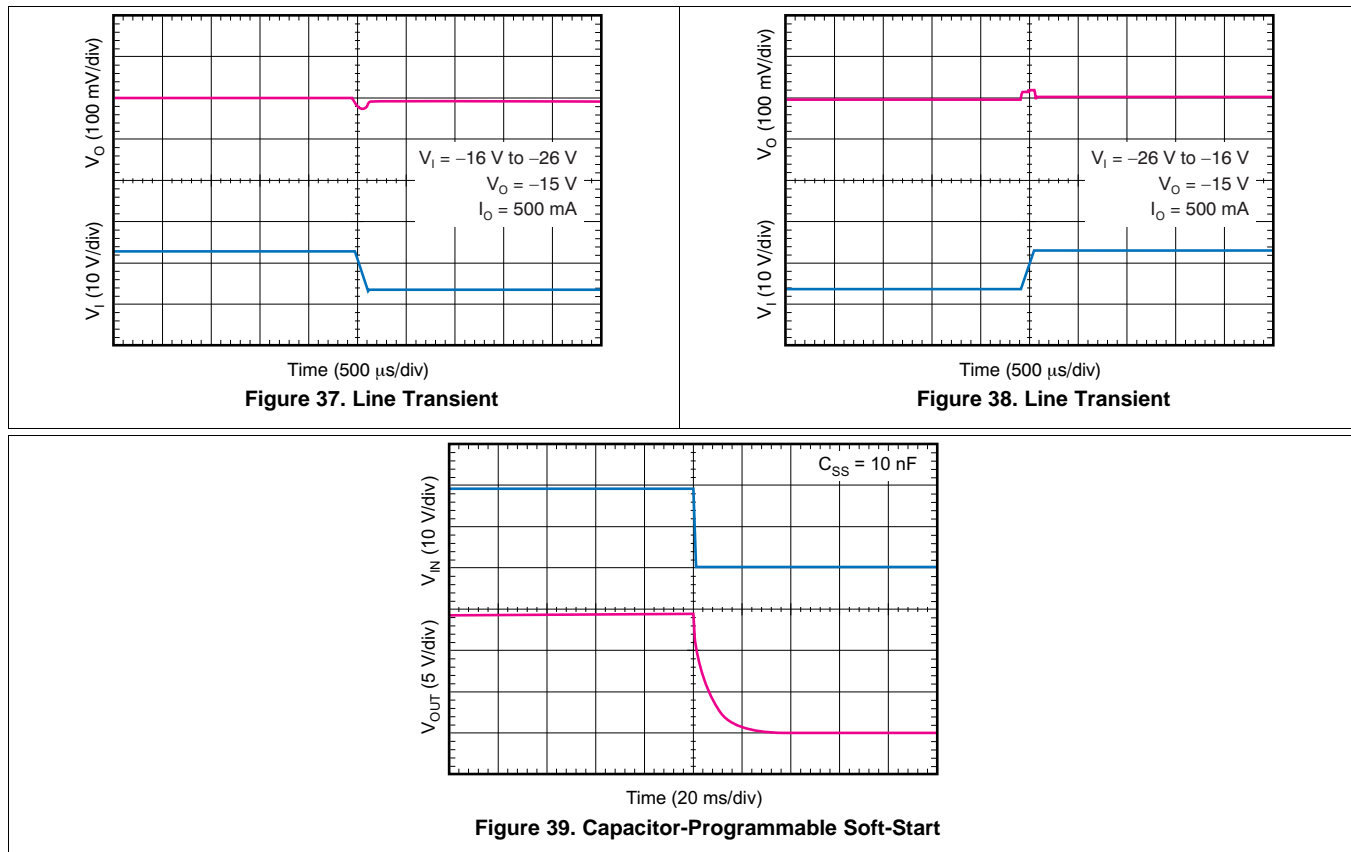
Typical Application (continued)

8.3 Do's and Don'ts

Place at least one low ESR 10- μF capacitor as close as possible to both the IN and OUT terminals of the regulator to the GND pin.

Provide adequate thermal paths away from the device.

Do not place the input or output capacitor more than 10 mm away from the regulator.

Do not exceed the absolute maximum ratings.

Do not float the EN pin.

Do not resistively or inductively load the NR/SS pin.

9 Power Supply Recommendations

The input supply for the LDO must be within its recommended operating conditions, from -35 V to -3 V . The input voltage must provide adequate headroom for the device to have a regulated output. If the input supply is noisy, additional input capacitors with low ESR can help improve the output noise performance.

10 Layout

Layout is a critical part of good power-supply design. Several signal paths that conduct fast-changing currents or voltages can interact with stray inductance or parasitic capacitance to generate noise or degrade the power-supply performance. To help eliminate these problems, the IN pin should be bypassed to ground with a low ESR ceramic bypass capacitor with a X5R or X7R dielectric.

10.1 Layout Guidelines

10.1.1 Improve PSRR and Noise Performance

To improve AC performance such as PSRR, output noise, and transient response, TI recommends designing the board with separate planes for IN, OUT, and GND. The IN and OUT planes should be isolated from each other by a GND plane section. In addition, the ground connection for the output capacitor should connect directly to the GND pin of the device.

Equivalent series inductance (ESL) and equivalent series resistance (ESR) must be minimized in order to maximize performance and ensure stability. Every capacitor (C_{IN} , C_{OUT} , $C_{NR/SS}$, C_{FF}) must be placed as close as possible to the device and on the same side of the PCB as the regulator itself.

Do not place any of the capacitors on the opposite side of the PCB from where the regulator is installed. The use of vias and long traces is strongly discouraged because they may impact system performance negatively and even cause instability.

10.2 Layout Example

It may be possible to obtain acceptable performance with alternative PCB layouts; however, the layout shown in [Figure 41](#) and the schematic shown in [Figure 42](#) have been shown to produce good results and are meant as a guideline.

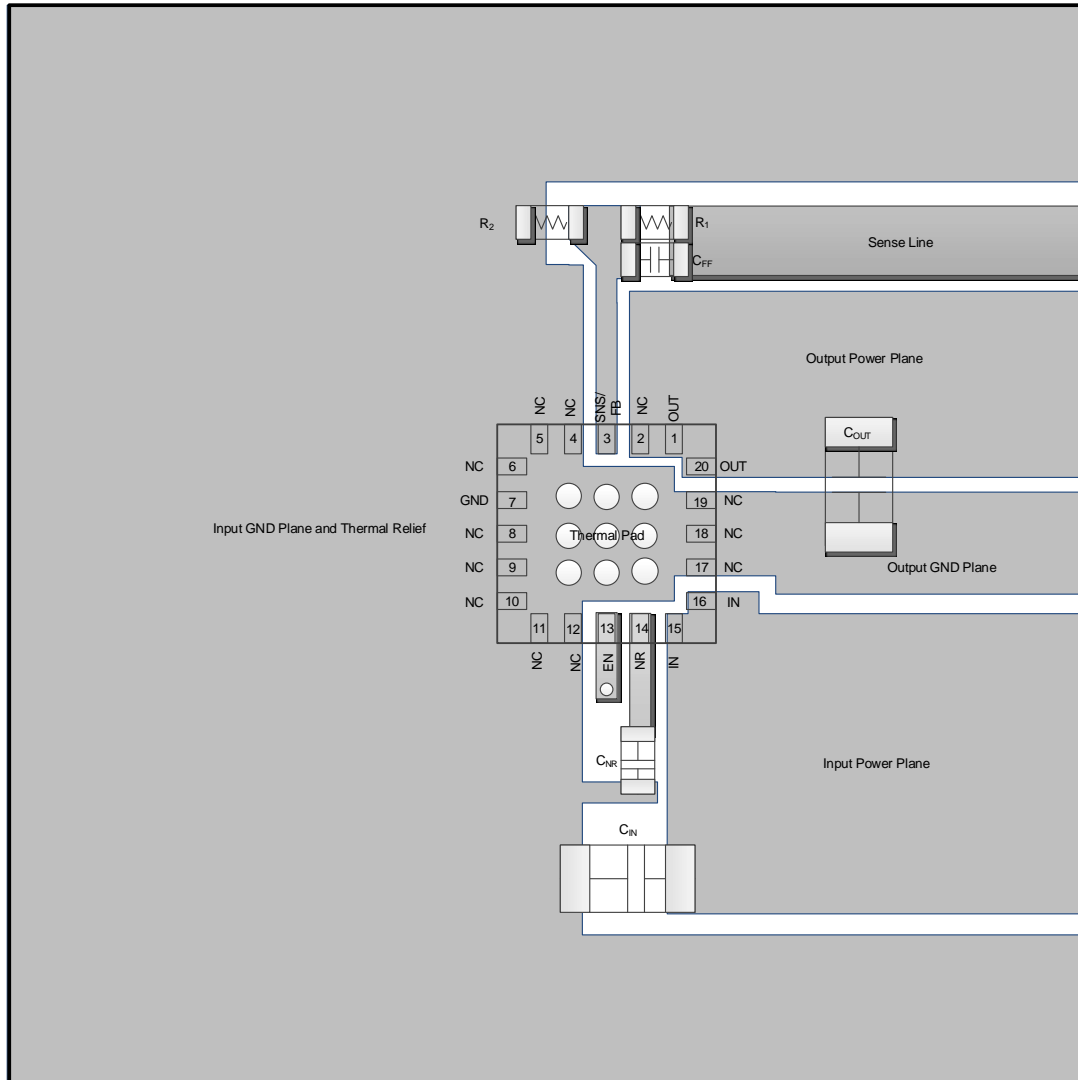

Scale is 8:1
This figure shows a 1x1 layout; expand to 3x3 or at least 2x2.

Figure 40. TPS7A33 5-mm x 5-mm QFN-20 Layout Guideline

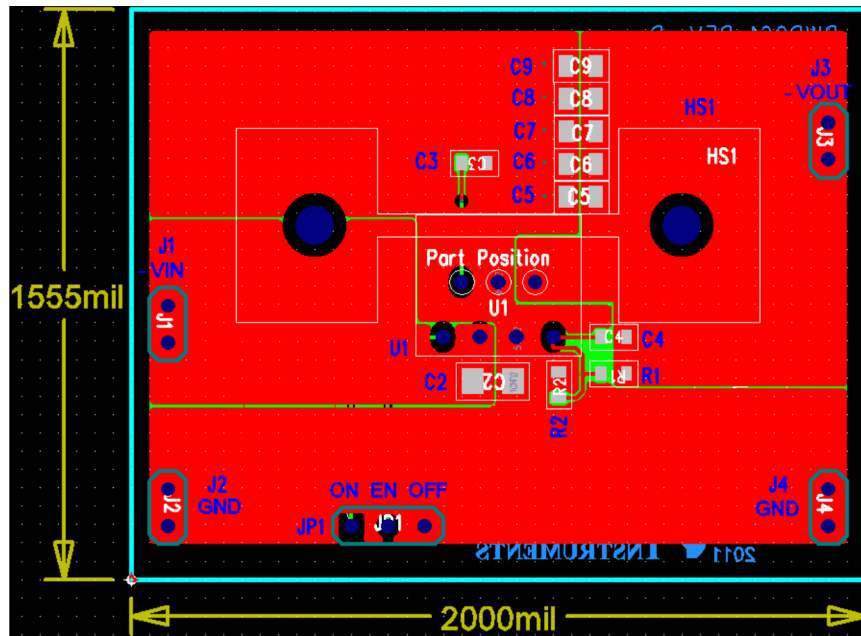

Figure 41. TPS7A33 TO-220 EVM PCB Layout Example: Top Layer

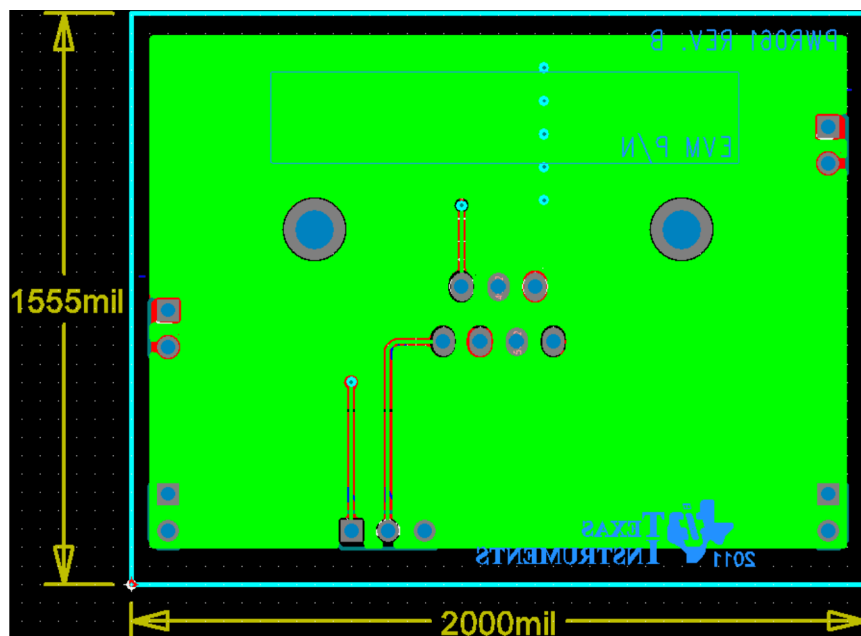

Figure 42. TPS7A33 TO-220 EVM PCB Layout Example: Bottom Layer

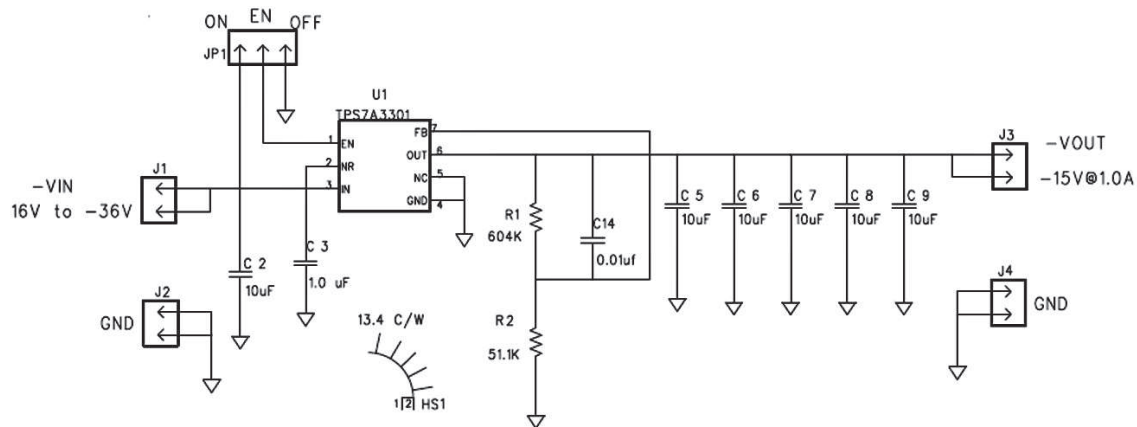

Figure 43. Schematic for TPS7A33 TO-220 EVM PCB Layout Example

10.3 Thermal Performance and Heat Sink Selection

The primary TPS7A33 application is to provide ultralow-noise voltage rails to high-performance analog circuitry in order to maximize system accuracy and precision. The high-current and high-voltage characteristics of this regulator means that, often enough, high power (heat) is dissipated from the device itself. This heat, if dissipated into the PCB (as is the case with SMT packages), creates a temperature gradient in the surrounding area that causes nearby components to react to this temperature change (drift). In high-performance systems, such drift may degrade overall system accuracy and precision.

Compared to surface-mount packages, the TO-220 (KC) package allows for an external heat sink to be used to maximize thermal performance and keep heat from dissipating into the PCB.

The heat generated by the device is a result of the power dissipation, which depends on input voltage and load conditions. Power dissipation (P_D) can be approximated by calculating the product of the output current times the voltage drop across the output pass element, as shown in Equation 4:

$$P_D = (V_{IN} - V_{OUT}) I_{OUT} \quad (4)$$

Heat flows from the device to the ambient air through many paths, each of which represents resistance to the heat flow; this effect is called thermal resistance.

The total thermal resistance of a system is defined by: $\theta_{JA} = (T_J - T_A)/P_D$; where: θ_{JA} is the thermal resistance (in $^{\circ}\text{C}/\text{W}$), T_J is the allowable junction temperature of the device (in $^{\circ}\text{C}$), T_A is the maximum temperature of the ambient cooling air (in $^{\circ}\text{C}$), and P_D is the amount of power (heat) dissipated by the device (in W).

Whenever a heat sink is installed, the total thermal resistance (θ_{JA}) is the sum of all the individual resistances from the device, going through its case and heatsink to the ambient cooling air ($\theta_{JA} = \theta_{JC} + \theta_{CS} + \theta_{SA}$). Realistically, only two resistances can be controlled: θ_{CS} and θ_{SA} . Therefore, for a device with a known θ_{JC} , θ_{CS} and θ_{SA} become the main design variables in selecting a heat sink.

The thermal interface between the case and the heat sink (θ_{CS}) is controlled by selecting the correct heat-conducting material. Once the θ_{CS} is selected, the required thermal resistance from the heat sink to ambient is calculated by the following equation: $\theta_{SA} = [(T_J - T_A)/P_D] - [\theta_{JC} + \theta_{CS}]$. This information allows the most appropriate heat sink to be selected for any particular application.

10.4 Package Mounting

The TO-220 (KC) 7-lead, straight-formed package lead spacing poses a challenge when creating a suitable PCB footprint without bending the leads. Component forming pliers can be used to manually bend the package leads into a 7-lead stagger pattern with increased lead spacing that can be more easily used.

The TPS7A33 evaluation board layout can be used as a guideline on suitable PCB footprints, available at www.ti.com. Refer to the [TPS7A3301EVM-061 user's guide](#) for more information.

11 器件和文档支持

11.1 器件支持

11.1.1 开发支持

11.1.1.1 评估模块

评估模块 (EVM) 可与 TPS7A33 配套使用, 帮助评估初始电路性能。 [TPS7A3301EVM-061 评估模块](#) (和相关的 [用户指南](#)) 可在德州仪器 (TI) 网站上的产品文件夹中获取, 也可直接从 [TI 网上商店](#) 购买。

11.1.1.2 Spice 模型

分析模拟电路和系统的性能时, 使用 SPICE 模型对电路性能进行计算机仿真非常有用。 您可以从产品文件夹中的 [工具和软件选项卡](#) 下获取 TPS7A33 的 SPICE 模型。

11.1.2 器件命名规则

表 3. 器件命名规则⁽¹⁾

产品	V _{OUT}
TPS7A3301YYYYZ	YYY 为封装标识符。 Z 为卷带数量 (R = 3000, T = 250)。

(1) 要获得最新的封装和订购信息, 请见本文档末尾的封装选项附录, 或者访问 TI 网站 www.ti.com。

11.2 文档支持

11.2.1 相关文档

相关文档如下 (下载网站 www.ti.com.cn) :

- 使用前馈电容器和低压降稳压器的优缺点, [SBVA042](#)
- 《[TPS7A3301EVM-061 评估模块用户指南](#)》, [SLVU602](#)

11.3 商标

All trademarks are the property of their respective owners.

11.4 静电放电警告



这些装置包含有限的内置 ESD 保护。 存储或装卸时, 应将导线一起截短或将装置放置于导电泡棉中, 以防止 MOS 门极遭受静电损伤。

11.5 术语表

[SLYZ022](#) — TI 术语表。

这份术语表列出并解释术语、首字母缩略词和定义。

12 机械封装和可订购信息

以下页中包括机械封装和可订购信息。 这些信息是针对指定器件可提供的最新数据。 这些数据会在无通知且不对本文档进行修订的情况下发生改变。 欲获得该数据表的浏览器版本, 请查阅左侧的导航栏。

重要声明

德州仪器(TI)及其下属子公司有权根据 JESD46 最新标准,对所提供的产品和服务进行更正、修改、增强、改进或其它更改,并有权根据 JESD48 最新标准中止提供任何产品和服务。客户在下订单前应获取最新的相关信息,并验证这些信息是否完整且是最新的。所有产品的销售都遵循在订单确认时所提供的TI 销售条款与条件。

TI 保证其所销售的组件的性能符合产品销售时 TI 半导体产品销售条件与条款的适用规范。仅在 TI 保证的范围内,且 TI 认为有必要时才会使用测试或其它质量控制技术。除非适用法律做出了硬性规定,否则没有必要对每种组件的所有参数进行测试。

TI 对应用帮助或客户产品设计不承担任何义务。客户应对其使用 TI 组件的产品和应用自行负责。为尽量减小与客户产品和应用相关的风险,客户应提供充分的设计与操作安全措施。

TI 不对任何 TI 专利权、版权、屏蔽作品权或其它与使用了 TI 组件或服务的组合设备、机器或流程相关的 TI 知识产权中授予的直接或隐含权限作出任何保证或解释。TI 所发布的与第三方产品或服务有关的信息,不能构成从 TI 获得使用这些产品或服务的许可、授权、或认可。使用此类信息可能需要获得第三方的专利权或其它知识产权方面的许可,或是 TI 的专利权或其它知识产权方面的许可。

对于 TI 的产品手册或数据表中 TI 信息的重要部分,仅在没有对内容进行任何篡改且带有相关授权、条件、限制和声明的情况下才允许进行复制。TI 对此类篡改过的文件不承担任何责任或义务。复制第三方的信息可能需要服从额外的限制条件。

在转售 TI 组件或服务时,如果对该组件或服务参数的陈述与 TI 标明的参数相比存在差异或虚假成分,则会失去相关 TI 组件或服务的所有明示或暗示授权,且这是不正当的、欺诈性商业行为。TI 对任何此类虚假陈述均不承担任何责任或义务。

客户认可并同意,尽管任何应用相关信息或支持仍可能由 TI 提供,但他们将独立负责满足与其产品及其在应用中使用的 TI 产品相关的所有法律、法规和安全相关要求。客户声明并同意,他们具备制定与实施安全措施所需的全部专业技术和知识,可预见故障的危险后果、监测故障及其后果、降低有可能造成人身伤害的故障的发生机率并采取适当的补救措施。客户将全额赔偿因在此类安全关键应用中使用任何 TI 组件而对 TI 及其代理造成的任何损失。

在某些场合中,为了推进安全相关应用有可能对 TI 组件进行特别的促销。TI 的目标是利用此类组件帮助客户设计和创立其特有的可满足适用的功能安全性标准和要求的终端产品解决方案。尽管如此,此类组件仍然服从这些条款。

TI 组件未获得用于 FDA Class III (或类似的生命攸关医疗设备)的授权许可,除非各方授权官员已经达成了专门管控此类使用的特别协议。

只有那些 TI 特别注明属于军用等级或“增强型塑料”的 TI 组件才是设计或专门用于军事/航空应用或环境的。购买者认可并同意,对并非指定面向军事或航空航天用途的 TI 组件进行军事或航空航天方面的应用,其风险由客户单独承担,并且由客户独立负责满足与此类使用相关的所有法律和法规要求。

TI 已明确指定符合 ISO/TS16949 要求的产品,这些产品主要用于汽车。在任何情况下,因使用非指定产品而无法达到 ISO/TS16949 要求, TI 不承担任何责任。

	产品		应用
数字音频	www.ti.com.cn/audio	通信与电信	www.ti.com.cn/telecom
放大器和线性器件	www.ti.com.cn/amplifiers	计算机及周边	www.ti.com.cn/computer
数据转换器	www.ti.com.cn/dataconverters	消费电子	www.ti.com.cn/consumer-apps
DLP® 产品	www.dlp.com	能源	www.ti.com.cn/energy
DSP - 数字信号处理器	www.ti.com.cn/dsp	工业应用	www.ti.com.cn/industrial
时钟和计时器	www.ti.com.cn/clockandtimers	医疗电子	www.ti.com.cn/medical
接口	www.ti.com.cn/interface	安防应用	www.ti.com.cn/security
逻辑	www.ti.com.cn/logic	汽车电子	www.ti.com.cn/automotive
电源管理	www.ti.com.cn/power	视频和影像	www.ti.com.cn/video
微控制器 (MCU)	www.ti.com.cn/microcontrollers		
RFID 系统	www.ti.com.cn/rfidsys		
OMAP应用处理器	www.ti.com/omap		
无线连通性	www.ti.com.cn/wirelessconnectivity	德州仪器在线技术支持社区	www.deyisupport.com

邮寄地址: 上海市浦东新区世纪大道1568号, 中建大厦32楼邮政编码: 200122
Copyright © 2015, 德州仪器半导体技术(上海)有限公司

PACKAGING INFORMATION

Orderable Device	Status (1)	Package Type	Package Drawing	Pins	Package Qty	Eco Plan (2)	Lead/Ball Finish (6)	MSL Peak Temp (3)	Op Temp (°C)	Device Marking (4/5)	Samples
TPS7A3301KC	ACTIVE	TO-220	KC	7	50	Pb-Free (RoHS)	CU SN	Level-2-260C-1 YEAR	-40 to 125	PPQQ	Samples
TPS7A3301RGWR	ACTIVE	VQFN	RGW	20	3000	Green (RoHS & no Sb/Br)	CU NIPDAU	Level-2-260C-1 YEAR	-40 to 125	PXQQ	Samples
TPS7A3301RGWT	ACTIVE	VQFN	RGW	20	250	Green (RoHS & no Sb/Br)	CU NIPDAU	Level-2-260C-1 YEAR	-40 to 125	PXQQ	Samples

(1) The marketing status values are defined as follows:

ACTIVE: Product device recommended for new designs.

LIFEBUY: TI has announced that the device will be discontinued, and a lifetime-buy period is in effect.

NRND: Not recommended for new designs. Device is in production to support existing customers, but TI does not recommend using this part in a new design.

PREVIEW: Device has been announced but is not in production. Samples may or may not be available.

OBSOLETE: TI has discontinued the production of the device.

(2) Eco Plan - The planned eco-friendly classification: Pb-Free (RoHS), Pb-Free (RoHS Exempt), or Green (RoHS & no Sb/Br) - please check <http://www.ti.com/productcontent> for the latest availability information and additional product content details.

TBD: The Pb-Free/Green conversion plan has not been defined.

Pb-Free (RoHS): TI's terms "Lead-Free" or "Pb-Free" mean semiconductor products that are compatible with the current RoHS requirements for all 6 substances, including the requirement that lead not exceed 0.1% by weight in homogeneous materials. Where designed to be soldered at high temperatures, TI Pb-Free products are suitable for use in specified lead-free processes.

Pb-Free (RoHS Exempt): This component has a RoHS exemption for either 1) lead-based flip-chip solder bumps used between the die and package, or 2) lead-based die adhesive used between the die and leadframe. The component is otherwise considered Pb-Free (RoHS compatible) as defined above.

Green (RoHS & no Sb/Br): TI defines "Green" to mean Pb-Free (RoHS compatible), and free of Bromine (Br) and Antimony (Sb) based flame retardants (Br or Sb do not exceed 0.1% by weight in homogeneous material)

(3) MSL, Peak Temp. - The Moisture Sensitivity Level rating according to the JEDEC industry standard classifications, and peak solder temperature.

(4) There may be additional marking, which relates to the logo, the lot trace code information, or the environmental category on the device.

(5) Multiple Device Markings will be inside parentheses. Only one Device Marking contained in parentheses and separated by a "~" will appear on a device. If a line is indented then it is a continuation of the previous line and the two combined represent the entire Device Marking for that device.

(6) Lead/Ball Finish - Orderable Devices may have multiple material finish options. Finish options are separated by a vertical ruled line. Lead/Ball Finish values may wrap to two lines if the finish value exceeds the maximum column width.

Important Information and Disclaimer: The information provided on this page represents TI's knowledge and belief as of the date that it is provided. TI bases its knowledge and belief on information provided by third parties, and makes no representation or warranty as to the accuracy of such information. Efforts are underway to better integrate information from third parties. TI has taken and

continues to take reasonable steps to provide representative and accurate information but may not have conducted destructive testing or chemical analysis on incoming materials and chemicals. TI and TI suppliers consider certain information to be proprietary, and thus CAS numbers and other limited information may not be available for release.

In no event shall TI's liability arising out of such information exceed the total purchase price of the TI part(s) at issue in this document sold by TI to Customer on an annual basis.

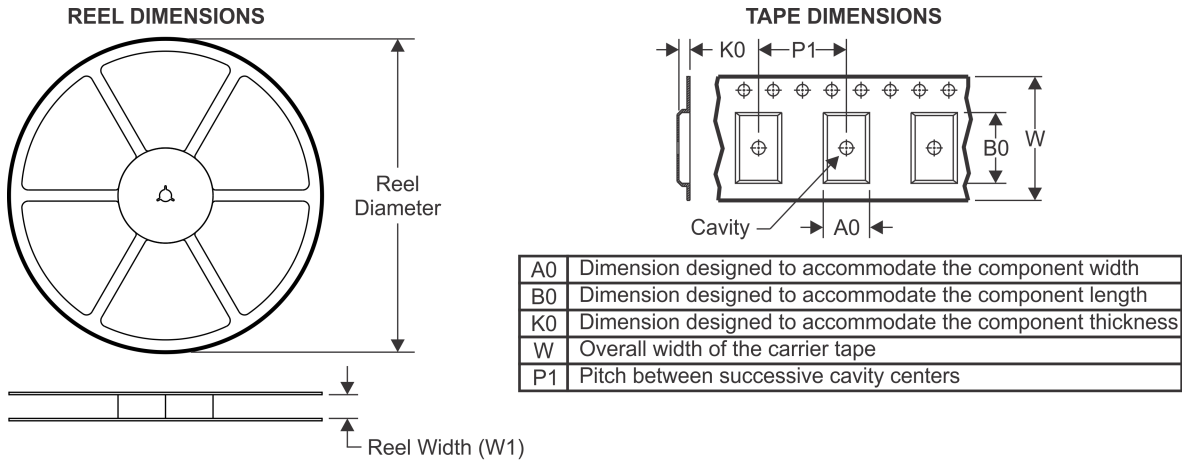
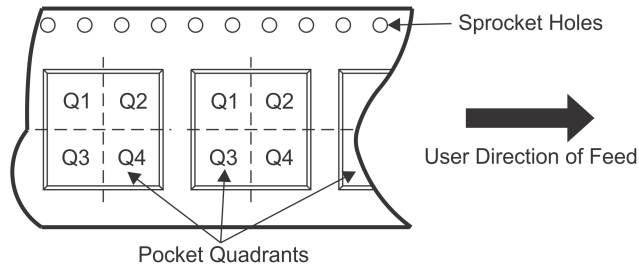
TAPE AND REEL INFORMATION

QUADRANT ASSIGNMENTS FOR PIN 1 ORIENTATION IN TAPE

*All dimensions are nominal

Device	Package Type	Package Drawing	Pins	SPQ	Reel Diameter (mm)	Reel Width W1 (mm)	A0 (mm)	B0 (mm)	K0 (mm)	P1 (mm)	W (mm)	Pin1 Quadrant
TPS7A3301RGWR	VQFN	RGW	20	3000	330.0	12.4	5.3	5.3	1.1	8.0	12.0	Q2
TPS7A3301RGWT	VQFN	RGW	20	250	180.0	12.4	5.3	5.3	1.1	8.0	12.0	Q2

TAPE AND REEL BOX DIMENSIONS



*All dimensions are nominal

Device	Package Type	Package Drawing	Pins	SPQ	Length (mm)	Width (mm)	Height (mm)
TPS7A3301RGWR	VQFN	RGW	20	3000	367.0	367.0	35.0
TPS7A3301RGWT	VQFN	RGW	20	250	210.0	185.0	35.0

MECHANICAL DATA

RGW (S-PVQFN-N20)

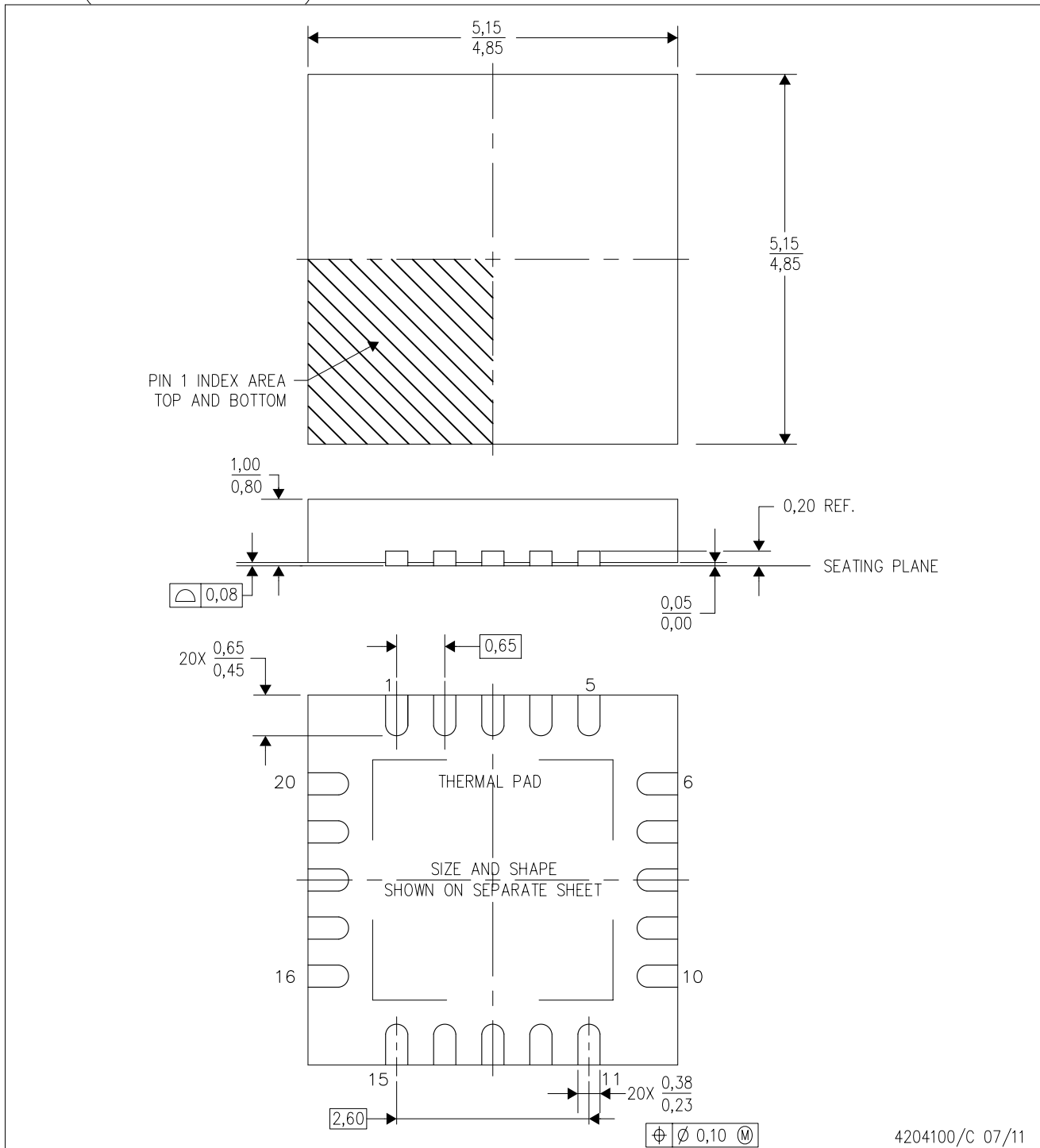
PLASTIC QUAD FLATPACK NO-LEAD



- NOTES:
- All linear dimensions are in millimeters. Dimensioning and tolerancing per ASME Y14.5-1994.
 - This drawing is subject to change without notice.
 - Quad Flat pack, No-leads (QFN) package configuration
 - The package thermal pad must be soldered to the board for thermal and mechanical performance.
 - See the additional figure in the Product Data Sheet for details regarding the exposed thermal pad features and dimensions.
 - Falls within JEDEC MO-220.

RGW (S-PVQFN-N20)

PLASTIC QUAD FLATPACK NO-LEAD

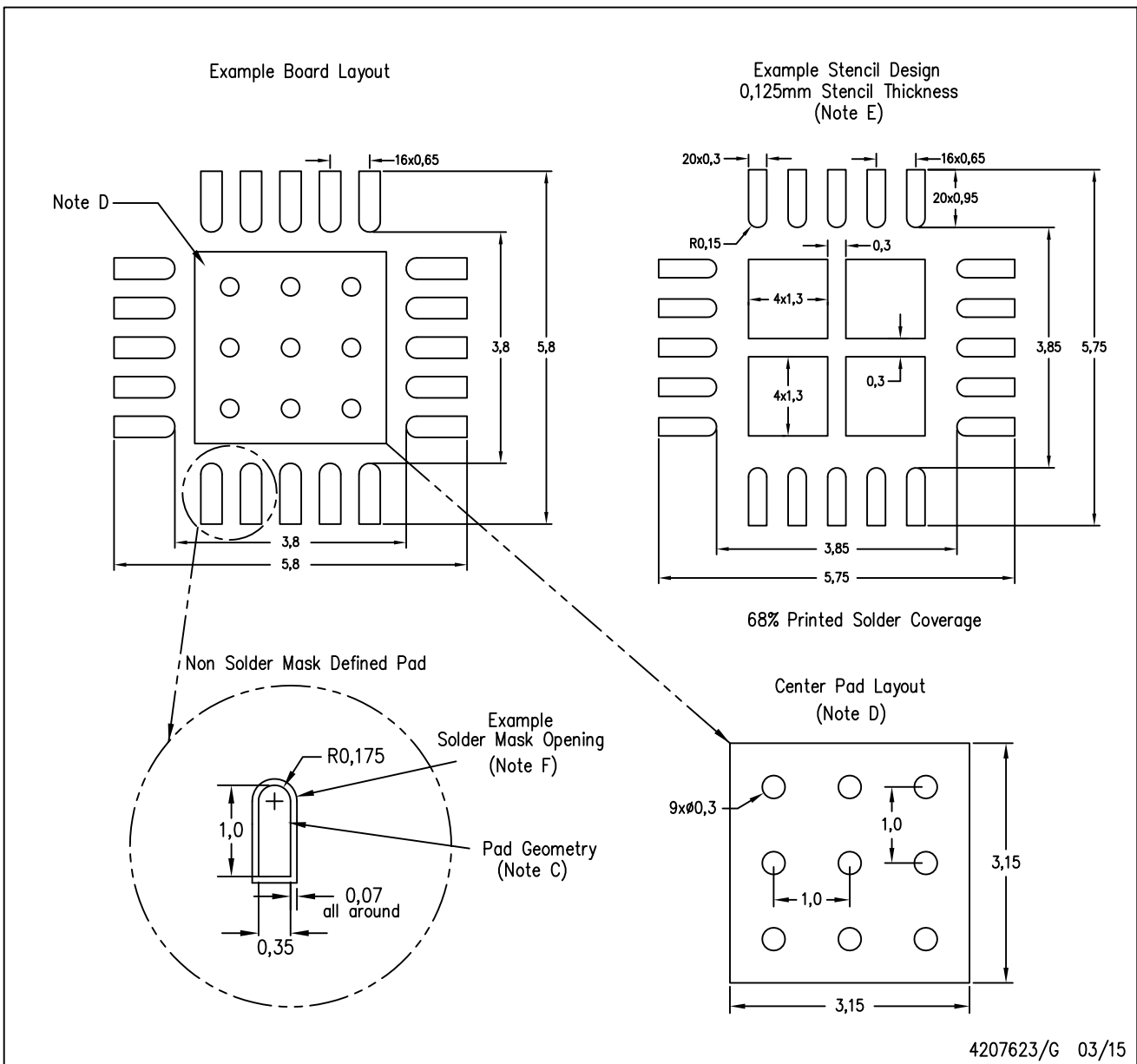

- NOTES:
- All linear dimensions are in millimeters.
 - This drawing is subject to change without notice.
 - Publication IPC-7351 is recommended for alternate designs.
 - This package is designed to be soldered to a thermal pad on the board. Refer to Application Note, QFN Packages, Texas Instruments Literature No. SLUA271, and also the Product Data Sheets for specific thermal information, via requirements, and recommended board layout. These documents are available at www.ti.com <<http://www.ti.com>>.
 - Laser cutting apertures with trapezoidal walls and also rounding corners will offer better paste release. Customers should contact their board assembly site for stencil design recommendations. Refer to IPC 7525 for stencil design considerations.
 - Customers should contact their board fabrication site for solder mask tolerances.

KC (R-PSFM-T7)

PLASTIC FLANGE-MOUNT PACKAGE

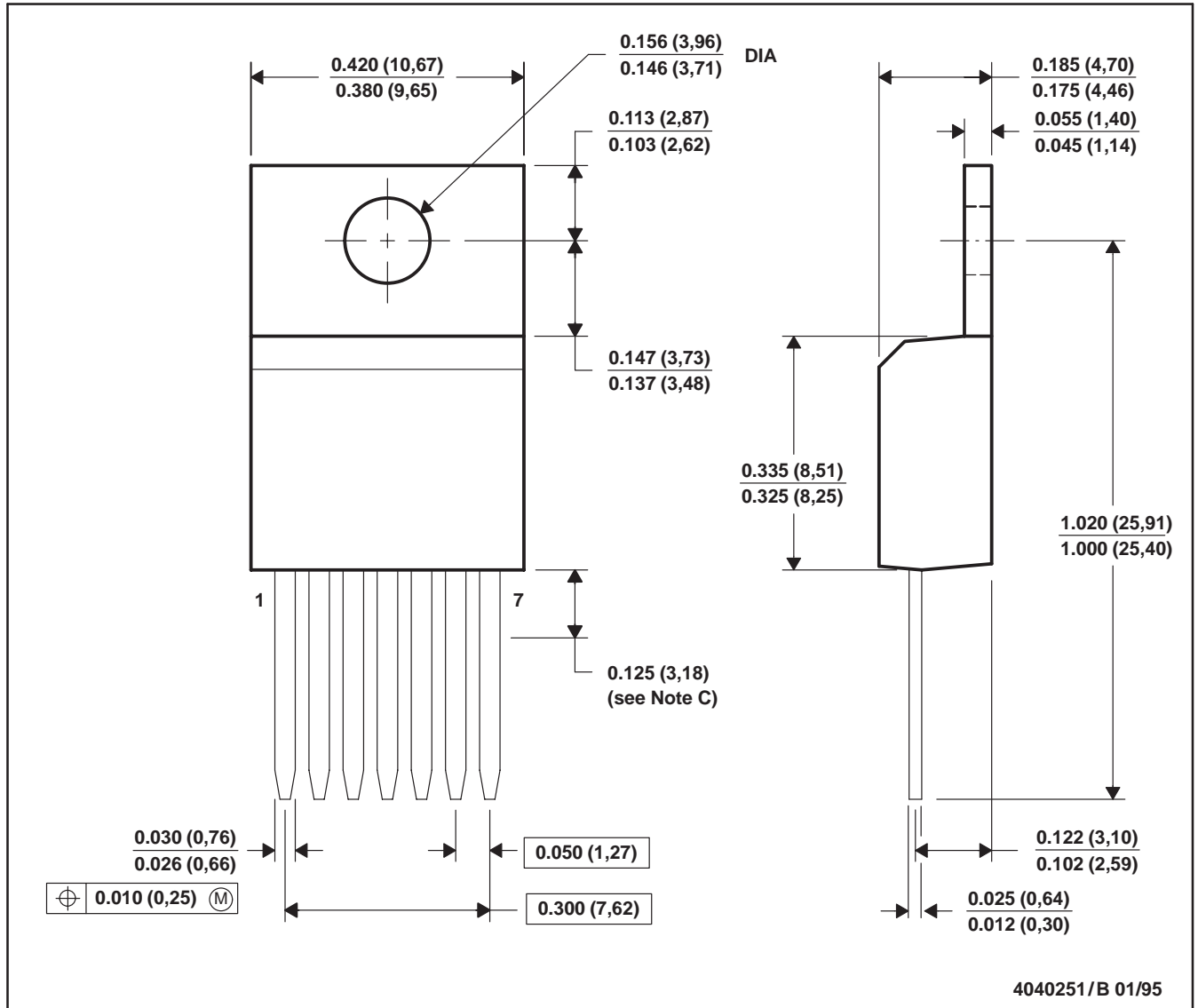

- NOTES: A. All linear dimensions are in inches (millimeters).
 B. This drawing is subject to change without notice.
 C. Lead dimensions are not controlled within this area.
 D. All lead dimensions apply before solder dip.
 E. The center lead is in electrical contact with the mounting tab.

重要声明

德州仪器(TI) 及其下属子公司有权根据 JESD46 最新标准, 对所提供的产品和服务进行更正、修改、增强、改进或其它更改, 并有权根据 JESD48 最新标准中止提供任何产品和服务。客户在下订单前应获取最新的相关信息, 并验证这些信息是否完整且是最新的。所有产品的销售都遵循在订单确认时所提供的TI 销售条款与条件。

TI 保证其所销售的组件的性能符合产品销售时 TI 半导体产品销售条件与条款的适用规范。仅在 TI 保证的范围内, 且 TI 认为有必要时才会使用测试或其它质量控制技术。除非适用法律做出了硬性规定, 否则没有必要对每种组件的所有参数进行测试。

TI 对应用帮助或客户产品设计不承担任何义务。客户应对其使用 TI 组件的产品和应用自行负责。为尽量减小与客户产品和应用相关的风险, 客户应提供充分的设计与操作安全措施。

TI 不对任何 TI 专利权、版权、屏蔽作品权或其它与使用了 TI 组件或服务的组合设备、机器或流程相关的 TI 知识产权中授予的直接或间接版权限作出任何保证或解释。TI 所发布的与第三方产品或服务有关的信息, 不能构成从 TI 获得使用这些产品或服务的许可、授权、或认可。使用此类信息可能需要获得第三方的专利权或其它知识产权方面的许可, 或是 TI 的专利权或其它知识产权方面的许可。

对于 TI 的产品手册或数据表中 TI 信息的重要部分, 仅在没有对内容进行任何篡改且带有相关授权、条件、限制和声明的情况下才允许进行复制。TI 对此类篡改过的文件不承担任何责任或义务。复制第三方的信息可能需要服从额外的限制条件。

在转售 TI 组件或服务时, 如果对该组件或服务参数的陈述与 TI 标明的参数相比存在差异或虚假成分, 则会失去相关 TI 组件或服务的所有明示或暗示授权, 且这是不正当的、欺诈性商业行为。TI 对任何此类虚假陈述均不承担任何责任或义务。

客户认可并同意, 尽管任何应用相关信息或支持仍可能由 TI 提供, 但他们将独自负责满足与其产品及其应用中使用 TI 产品相关的所有法律、法规和安全相关要求。客户声明并同意, 他们具备制定与实施安全措施所需的全部专业技术和知识, 可预见故障的危险后果、监测故障及其后果、降低有可能造成人身伤害的故障的发生机率并采取适当的补救措施。客户将全额赔偿因在此类安全关键应用中使用任何 TI 组件而对 TI 及其代理造成的任何损失。

在某些场合中, 为了推进安全相关应用有可能对 TI 组件进行特别的促销。TI 的目标是利用此类组件帮助客户设计和创立其特有的可满足适用的功能安全性标准和要求的终端产品解决方案。尽管如此, 此类组件仍然服从这些条款。

TI 组件未获得用于 FDA Class III (或类似的生命攸关医疗设备) 的授权许可, 除非各方授权官员已经达成了专门管控此类使用的特别协议。

只有那些 TI 特别注明属于军用等级或“增强型塑料”的 TI 组件才是设计或专门用于军事/航空应用或环境的。购买者认可并同意, 对并非指定面向军事或航空航天用途的 TI 组件进行军事或航空航天方面的应用, 其风险由客户单独承担, 并且由客户独自负责满足与此类使用相关的所有法律和法规要求。

TI 已明确指定符合 ISO/TS16949 要求的产品, 这些产品主要用于汽车。在任何情况下, 因使用非指定产品而无法达到 ISO/TS16949 要求, TI 不承担任何责任。

	产品		应用
数字音频	www.ti.com.cn/audio	通信与电信	www.ti.com.cn/telecom
放大器和线性器件	www.ti.com.cn/amplifiers	计算机及周边	www.ti.com.cn/computer
数据转换器	www.ti.com.cn/dataconverters	消费电子	www.ti.com.cn/consumer-apps
DLP® 产品	www.dlp.com	能源	www.ti.com.cn/energy
DSP - 数字信号处理器	www.ti.com.cn/dsp	工业应用	www.ti.com.cn/industrial
时钟和计时器	www.ti.com.cn/clockandtimers	医疗电子	www.ti.com.cn/medical
接口	www.ti.com.cn/interface	安防应用	www.ti.com.cn/security
逻辑	www.ti.com.cn/logic	汽车电子	www.ti.com.cn/automotive
电源管理	www.ti.com.cn/power	视频和影像	www.ti.com.cn/video
微控制器 (MCU)	www.ti.com.cn/microcontrollers		
RFID 系统	www.ti.com.cn/rfidsys		
OMAP应用处理器	www.ti.com.cn/omap		
无线连通性	www.ti.com.cn/wirelessconnectivity	德州仪器在线技术支持社区	www.deyisupport.com

Mailing Address: Texas Instruments, Post Office Box 655303, Dallas, Texas 75265
Copyright © 2015, Texas Instruments Incorporated