

# MC7800, MC7800A, MC7800AE, NCV7800



ON Semiconductor®

<http://onsemi.com>

## 1.0 A Positive Voltage Regulators

These voltage regulators are monolithic integrated circuits designed as fixed-voltage regulators for a wide variety of applications including local, on-card regulation. These regulators employ internal current limiting, thermal shutdown, and safe-area compensation. With adequate heatsinking they can deliver output currents in excess of 1.0 A. Although designed primarily as a fixed voltage regulator, these devices can be used with external components to obtain adjustable voltages and currents.

### Features

- Output Current in Excess of 1.0 A
- No External Components Required
- Internal Thermal Overload Protection
- Internal Short Circuit Current Limiting
- Output Transistor Safe-Area Compensation
- Output Voltage Offered in 1.5%, 2% and 4% Tolerance
- Available in Surface Mount D<sup>2</sup>PAK-3, DPAK-3 and Standard 3-Lead Transistor Packages
- NCV Prefix for Automotive and Other Applications Requiring Unique Site and Control Change Requirements; AEC-Q100 Qualified and PPAP Capable
- These are Pb-Free Devices

### MAXIMUM RATINGS (T<sub>A</sub> = 25°C, unless otherwise noted)

Rating	Symbol	Value			Unit
		369C	221A	936	
Input Voltage (5.0 – 18 V) (24 V)	V <sub>I</sub>	35 40			Vdc
Power Dissipation	P <sub>D</sub>	Internally Limited			W
Thermal Resistance, Junction-to-Ambient	R <sub>θJA</sub>	92	65	Figure 15	°C/W
Thermal Resistance, Junction-to-Case	R <sub>θJC</sub>	5.0	5.0	5.0	°C/W
Storage Junction Temperature Range	T <sub>stg</sub>	-65 to +150			°C
Operating Junction Temperature	T <sub>J</sub>	+150			°C

Stresses exceeding those listed in the Maximum Ratings table may damage the device. If any of these limits are exceeded, device functionality should not be assumed, damage may occur and reliability may be affected.

\*This device series contains ESD protection and exceeds the following tests:  
Human Body Model 2000 V per MIL\_STD\_883, Method 3015.  
Machine Model Method 200 V.

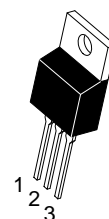

TO-220  
T SUFFIX  
CASE 221AB

Heatsink surface  
connected to Pin 2.

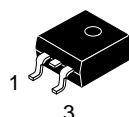

Pin 1. Input  
2. Ground  
3. Output

D<sup>2</sup>PAK-3  
D2T SUFFIX  
CASE 936

Heatsink surface (shown as terminal 4 in case outline drawing) is connected to Pin 2.

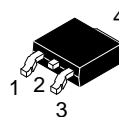

DPAK-3  
DT SUFFIX  
CASE 369C

### STANDARD APPLICATION

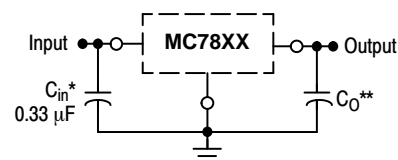

A common ground is required between the input and the output voltages. The input voltage must remain typically 2.0 V above the output voltage even during the low point on the input ripple voltage.

XX, These two digits of the type number indicate nominal voltage.

\* C<sub>in</sub> is required if regulator is located an appreciable distance from power supply filter.

\*\* C<sub>O</sub> is not needed for stability; however, it does improve transient response. Values of less than 0.1 μF could cause instability.

### ORDERING INFORMATION

See detailed ordering and shipping information in the package dimensions section on page 23 of this data sheet.

### DEVICE MARKING INFORMATION

See general marking information in the device marking section on page 28 of this data sheet.

# MC7800, MC7800A, MC7800AE, NCV7800

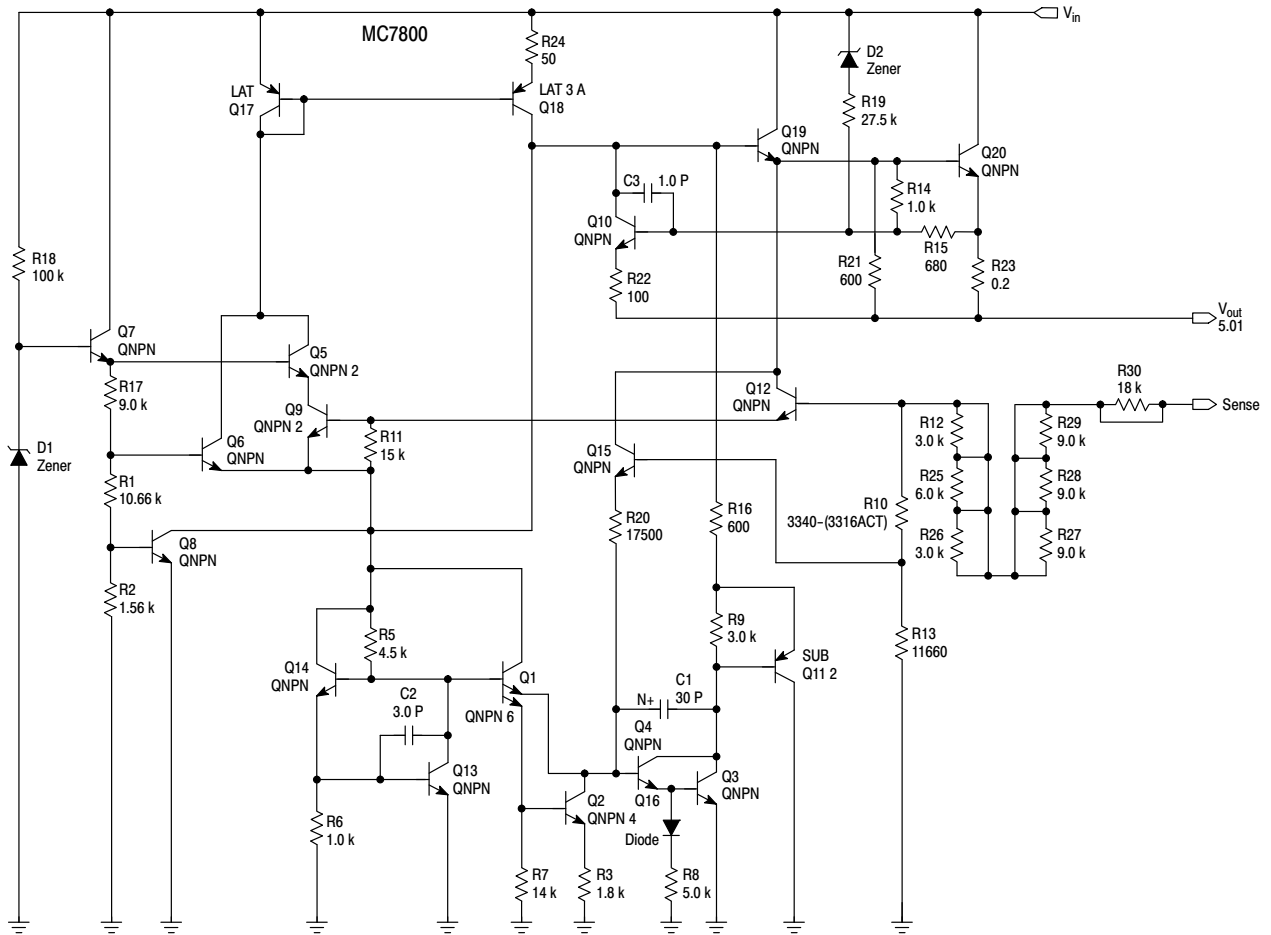

This device contains 22 active transistors.

**Figure 1. Representative Schematic Diagram**

# MC7800, MC7800A, MC7800AE, NCV7800

**ELECTRICAL CHARACTERISTICS** ( $V_{in} = 10\text{ V}$ ,  $I_O = 500\text{ mA}$ ,  $T_J = T_{low}$  to  $125^\circ\text{C}$  (Note 1), unless otherwise noted)

Characteristic	Symbol	MC7805B, NCV7805B			MC7805C			Unit
		Min	Typ	Max	Min	Typ	Max	
Output Voltage ( $T_J = 25^\circ\text{C}$ )	$V_O$	4.8	5.0	5.2	4.8	5.0	5.2	Vdc
Output Voltage ( $5.0\text{ mA} \leq I_O \leq 1.0\text{ A}$ , $P_D \leq 15\text{ W}$ ) $7.0\text{ Vdc} \leq V_{in} \leq 20\text{ Vdc}$ $8.0\text{ Vdc} \leq V_{in} \leq 20\text{ Vdc}$	$V_O$	– 4.75	– 5.0	– 5.25	4.75 –	5.0 –	5.25 –	Vdc
Line Regulation (Note 4) $7.5\text{ Vdc} \leq V_{in} \leq 20\text{ Vdc}$ , $1.0\text{ A}$ $8.0\text{ Vdc} \leq V_{in} \leq 12\text{ Vdc}$	$Reg_{line}$	– –	5.0 1.3	100 50	– –	0.5 0.8	20 10	mV
Load Regulation (Note 4) $5.0\text{ mA} \leq I_O \leq 1.0\text{ A}$ $5.0\text{ mA} \leq I_O \leq 1.5\text{ A}$ ( $T_A = 25^\circ\text{C}$ )	$Reg_{load}$	– –	1.3 0.15	100 50	– –	1.3 1.3	25 25	mV
Quiescent Current	$I_B$	–	3.2	8.0	–	3.2	6.5	mA
Quiescent Current Change $7.0\text{ Vdc} \leq V_{in} \leq 25\text{ Vdc}$ $5.0\text{ mA} \leq I_O \leq 1.0\text{ A}$ ( $T_A = 25^\circ\text{C}$ )	$\Delta I_B$	– –	– –	– 0.5	– –	0.3 0.08	1.0 0.8	mA
Ripple Rejection $8.0\text{ Vdc} \leq V_{in} \leq 18\text{ Vdc}$ , $f = 120\text{ Hz}$	RR	–	68	–	62	83	–	dB
Dropout Voltage ( $I_O = 1.0\text{ A}$ , $T_J = 25^\circ\text{C}$ )	$V_I - V_O$	–	2.0	–	–	2.0	–	Vdc
Output Noise Voltage ( $T_A = 25^\circ\text{C}$ ) $10\text{ Hz} \leq f \leq 100\text{ kHz}$	$V_n$	–	10	–	–	10	–	$\mu\text{V}/V_O$
Output Resistance $f = 1.0\text{ kHz}$	$r_O$	–	0.9	–	–	0.9	–	$\text{m}\Omega$
Short Circuit Current Limit ( $T_A = 25^\circ\text{C}$ ) $V_{in} = 35\text{ Vdc}$	$I_{SC}$	–	0.2	–	–	0.6	–	A
Peak Output Current ( $T_J = 25^\circ\text{C}$ )	$I_{max}$	–	2.2	–	–	2.2	–	A
Average Temperature Coefficient of Output Voltage	$TCV_O$	–	–0.3	–	–	–0.3	–	$\text{mV}/^\circ\text{C}$

- $T_{low} = 0^\circ\text{C}$  for MC78XXC, MC78XXAC,  
 $= -40^\circ\text{C}$  for NCV78XX, MC78XXB, MC78XXAB, and MC78XXAEB
- Load and line regulation are specified at constant junction temperature. Changes in  $V_O$  due to heating effects must be taken into account separately. Pulse testing with low duty cycle is used.

# MC7800, MC7800A, MC7800AE, NCV7800

## ELECTRICAL CHARACTERISTICS ( $V_{in} = 10\text{ V}$ , $I_O = 1.0\text{ A}$ , $T_J = T_{low}$ to $125^\circ\text{C}$ (Note 3), unless otherwise noted)

Characteristic	Symbol	MC7805AB/MC7805AC/NCV7805AB			Unit
		Min	Typ	Max	
Output Voltage ( $T_J = 25^\circ\text{C}$ )	$V_O$	4.9	5.0	5.1	Vdc
Output Voltage ( $5.0\text{ mA} \leq I_O \leq 1.0\text{ A}$ , $P_D \leq 15\text{ W}$ ) $7.5\text{ Vdc} \leq V_{in} \leq 20\text{ Vdc}$	$V_O$	4.8	5.0	5.2	Vdc
Line Regulation (Note 4) $7.5\text{ Vdc} \leq V_{in} \leq 25\text{ Vdc}$ , $I_O = 500\text{ mA}$ $8.0\text{ Vdc} \leq V_{in} \leq 12\text{ Vdc}$ , $I_O = 1.0\text{ A}$ $8.0\text{ Vdc} \leq V_{in} \leq 12\text{ Vdc}$ , $I_O = 1.0\text{ A}$ , $T_J = 25^\circ\text{C}$ $7.3\text{ Vdc} \leq V_{in} \leq 20\text{ Vdc}$ , $I_O = 1.0\text{ A}$ , $T_J = 25^\circ\text{C}$	$Reg_{line}$	–	0.5 0.8 1.3 4.5	10 12 4.0 10	mV
Load Regulation (Note 4) $5.0\text{ mA} \leq I_O \leq 1.5\text{ A}$ , $T_J = 25^\circ\text{C}$ $5.0\text{ mA} \leq I_O \leq 1.0\text{ A}$ $250\text{ mA} \leq I_O \leq 750\text{ mA}$	$Reg_{load}$	–	1.3 0.8 0.53	25 25 15	mV
Quiescent Current	$I_B$	–	3.2	6.0	mA
Quiescent Current Change $8.0\text{ Vdc} \leq V_{in} \leq 25\text{ Vdc}$ , $I_O = 500\text{ mA}$ $7.5\text{ Vdc} \leq V_{in} \leq 20\text{ Vdc}$ , $T_J = 25^\circ\text{C}$ $5.0\text{ mA} \leq I_O \leq 1.0\text{ A}$	$\Delta I_B$	–	0.3 – 0.08	0.8 0.8 0.5	mA
Ripple Rejection $8.0\text{ Vdc} \leq V_{in} \leq 18\text{ Vdc}$ , $f = 120\text{ Hz}$ , $I_O = 500\text{ mA}$	RR	68	83	–	dB
Dropout Voltage ( $I_O = 1.0\text{ A}$ , $T_J = 25^\circ\text{C}$ )	$V_I - V_O$	–	2.0	–	Vdc
Output Noise Voltage ( $T_A = 25^\circ\text{C}$ ) $10\text{ Hz} \leq f \leq 100\text{ kHz}$	$V_n$	–	10	–	$\mu\text{V}/V_O$
Output Resistance ( $f = 1.0\text{ kHz}$ )	$r_O$	–	0.9	–	$\text{m}\Omega$
Short Circuit Current Limit ( $T_A = 25^\circ\text{C}$ ) $V_{in} = 35\text{ Vdc}$	$I_{SC}$	–	0.2	–	A
Peak Output Current ( $T_J = 25^\circ\text{C}$ )	$I_{max}$	–	2.2	–	A
Average Temperature Coefficient of Output Voltage	$TCV_O$	–	–0.3	–	$\text{mV}/^\circ\text{C}$

3.  $T_{low} = 0^\circ\text{C}$  for MC78XXC, MC78XXAC,

=  $-40^\circ\text{C}$  for NCV78XX, MC78XXB, MC78XXAB, and MC78XXAEB

4. Load and line regulation are specified at constant junction temperature. Changes in  $V_O$  due to heating effects must be taken into account separately. Pulse testing with low duty cycle is used.

## MC7800, MC7800A, MC7800AE, NCV7800

**ELECTRICAL CHARACTERISTICS** ( $V_{in} = 11\text{ V}$ ,  $I_O = 500\text{ mA}$ ,  $T_J = T_{low}$  to  $125^\circ\text{C}$  (Note 5), unless otherwise noted)

Characteristic	Symbol	MC7806B/NCV7806B			MC7806C			Unit
		Min	Typ	Max	Min	Typ	Max	
Output Voltage ( $T_J = 25^\circ\text{C}$ )	$V_O$	5.75	6.0	6.25	5.75	6.0	6.25	Vdc
Output Voltage ( $5.0\text{ mA} \leq I_O \leq 1.0\text{ A}$ , $P_D \leq 15\text{ W}$ ) 8.0 Vdc $\leq V_{in} \leq 21\text{ Vdc}$ 9.0 Vdc $\leq V_{in} \leq 21\text{ Vdc}$	$V_O$	– 5.7	– 6.0	– 6.3	5.7 –	6.0 –	6.3 –	Vdc
Line Regulation, $T_J = 25^\circ\text{C}$ (Note 6) 8.0 Vdc $\leq V_{in} \leq 25\text{ Vdc}$ 9.0 Vdc $\leq V_{in} \leq 13\text{ Vdc}$	$Reg_{line}$	– –	5.5 1.4	120 60	– –	0.5 0.8	24 12	mV
Load Regulation, $T_J = 25^\circ\text{C}$ (Note 6) $5.0\text{ mA} \leq I_O \leq 1.5\text{ A}$	$Reg_{load}$	–	1.3	120	–	1.3	30	mV
Quiescent Current ( $T_J = 25^\circ\text{C}$ )	$I_B$	–	3.3	8.0	–	3.3	8.0	mA
Quiescent Current Change 8.0 Vdc $\leq V_{in} \leq 25\text{ Vdc}$ $5.0\text{ mA} \leq I_O \leq 1.0\text{ A}$	$\Delta I_B$	– –	– –	– 0.5	– –	0.3 0.08	1.3 0.5	mA
Ripple Rejection 9.0 Vdc $\leq V_{in} \leq 19\text{ Vdc}$ , $f = 120\text{ Hz}$	RR	–	65	–	58	65	–	dB
Dropout Voltage ( $I_O = 1.0\text{ A}$ , $T_J = 25^\circ\text{C}$ )	$V_I - V_O$	–	2.0	–	–	2.0	–	Vdc
Output Noise Voltage ( $T_A = 25^\circ\text{C}$ ) $10\text{ Hz} \leq f \leq 100\text{ kHz}$	$V_n$	–	10	–	–	10	–	$\mu\text{V}/V_O$
Output Resistance $f = 1.0\text{ kHz}$	$r_O$	–	0.9	–	–	0.9	–	$\text{m}\Omega$
Short Circuit Current Limit ( $T_A = 25^\circ\text{C}$ ) $V_{in} = 35\text{ Vdc}$	$I_{SC}$	–	0.2	–	–	0.2	–	A
Peak Output Current ( $T_J = 25^\circ\text{C}$ )	$I_{max}$	–	2.2	–	–	2.2	–	A
Average Temperature Coefficient of Output Voltage	$TCV_O$	–	–0.3	–	–	–0.3	–	$\text{mV}/^\circ\text{C}$

5.  $T_{low} = 0^\circ\text{C}$  for MC78XXC, MC78XXAC,

=  $-40^\circ\text{C}$  for NCV78XX, MC78XXB, MC78XXAB, and MC78XXAEB

6. Load and line regulation are specified at constant junction temperature. Changes in  $V_O$  due to heating effects must be taken into account separately. Pulse testing with low duty cycle is used.

## MC7800, MC7800A, MC7800AE, NCV7800

**ELECTRICAL CHARACTERISTICS** ( $V_{in} = 11\text{ V}$ ,  $I_O = 1.0\text{ A}$ ,  $T_J = T_{low}$  to  $125^\circ\text{C}$  (Note 7), unless otherwise noted)

Characteristic	Symbol	MC7806AC			Unit
		Min	Typ	Max	
Output Voltage ( $T_J = 25^\circ\text{C}$ )	$V_O$	5.88	6.0	6.12	Vdc
Output Voltage ( $5.0\text{ mA} \leq I_O \leq 1.0\text{ A}$ , $P_D \leq 15\text{ W}$ ) $8.6\text{ Vdc} \leq V_{in} \leq 21\text{ Vdc}$	$V_O$	5.76	6.0	6.24	Vdc
Line Regulation (Note 8) $8.6\text{ Vdc} \leq V_{in} \leq 25\text{ Vdc}$ , $I_O = 500\text{ mA}$ $9.0\text{ Vdc} \leq V_{in} \leq 13\text{ Vdc}$ , $I_O = 1.0\text{ A}$	$Reg_{line}$	– –	5.0 1.4	12 15	mV
Load Regulation (Note 8) $5.0\text{ mA} \leq I_O \leq 1.5\text{ A}$ , $T_J = 25^\circ\text{C}$ $5.0\text{ mA} \leq I_O \leq 1.0\text{ A}$ $250\text{ mA} \leq I_O \leq 750\text{ mA}$	$Reg_{load}$	– – –	1.3 0.9 0.2	25 25 15	mV
Quiescent Current	$I_B$	–	3.3	6.0	mA
Quiescent Current Change $9.0\text{ Vdc} \leq V_{in} \leq 25\text{ Vdc}$ , $I_O = 500\text{ mA}$ $9.0\text{ Vdc} \leq V_{in} \leq 21\text{ Vdc}$ , $I_O = 1.0\text{ A}$ , $T_J = 25^\circ\text{C}$ $5.0\text{ mA} \leq I_O \leq 1.0\text{ A}$	$\Delta I_B$	– – –	– – –	0.8 0.8 0.5	mA
Ripple Rejection $9.0\text{ Vdc} \leq V_{in} \leq 19\text{ Vdc}$ , $f = 120\text{ Hz}$ , $I_O = 500\text{ mA}$	RR	58	65	–	dB
Dropout Voltage ( $I_O = 1.0\text{ A}$ , $T_J = 25^\circ\text{C}$ )	$V_I - V_O$	–	2.0	–	Vdc
Output Noise Voltage ( $T_A = 25^\circ\text{C}$ ) $10\text{ Hz} \leq f \leq 100\text{ kHz}$	$V_n$	–	10	–	$\mu\text{V}/V_O$
Output Resistance ( $f = 1.0\text{ kHz}$ )	$r_O$	–	0.9	–	$\text{m}\Omega$
Short Circuit Current Limit ( $T_A = 25^\circ\text{C}$ ) $V_{in} = 35\text{ Vdc}$	$I_{sc}$	–	0.2	–	A
Peak Output Current ( $T_J = 25^\circ\text{C}$ )	$I_{max}$	–	2.2	–	A
Average Temperature Coefficient of Output Voltage	$TCV_O$	–	–0.3	–	$\text{mV}/^\circ\text{C}$

7.  $T_{low} = 0^\circ\text{C}$  for MC78XXC, MC78XXAC,

=  $-40^\circ\text{C}$  for NCV78XX, MC78XXB, MC78XXAB, and MC78XXAEB

8. Load and line regulation are specified at constant junction temperature. Changes in  $V_O$  due to heating effects must be taken into account separately. Pulse testing with low duty cycle is used.

# MC7800, MC7800A, MC7800AE, NCV7800

**ELECTRICAL CHARACTERISTICS** ( $V_{in} = 14\text{ V}$ ,  $I_O = 500\text{ mA}$ ,  $T_J = T_{low}$  to  $125^\circ\text{C}$  (Note 9), unless otherwise noted)

Characteristic	Symbol	MC7808B/NCV7808B			MC7808C			Unit
		Min	Typ	Max	Min	Typ	Max	
Output Voltage ( $T_J = 25^\circ\text{C}$ )	$V_O$	7.7	8.0	8.3	7.7	8.0	8.3	Vdc
Output Voltage ( $5.0\text{ mA} \leq I_O \leq 1.0\text{ A}$ , $P_D \leq 15\text{ W}$ ) $10.5\text{ Vdc} \leq V_{in} \leq 23\text{ Vdc}$ $11.5\text{ Vdc} \leq V_{in} \leq 23\text{ Vdc}$	$V_O$	– 7.6	– 8.0	– 8.4	7.6 –	8.0 –	8.4 –	Vdc
Line Regulation, $T_J = 25^\circ\text{C}$ , (Note 10) $10.5\text{ Vdc} \leq V_{in} \leq 25\text{ Vdc}$ $11\text{ Vdc} \leq V_{in} \leq 17\text{ Vdc}$	$Reg_{line}$	– –	6.0 1.7	160 80	– –	6.0 1.7	32 16	mV
Load Regulation, $T_J = 25^\circ\text{C}$ (Note 10) $5.0\text{ mA} \leq I_O \leq 1.5\text{ A}$	$Reg_{load}$	–	1.4	160	–	1.4	35	mV
Quiescent Current	$I_B$	–	3.3	8.0	–	3.3	8.0	mA
Quiescent Current Change $10.5\text{ Vdc} \leq V_{in} \leq 25\text{ Vdc}$ $5.0\text{ mA} \leq I_O \leq 1.0\text{ A}$	$\Delta I_B$	– –	– –	– 0.5	– –	– –	1.0 0.5	mA
Ripple Rejection $11.5\text{ Vdc} \leq V_{in} \leq 18\text{ Vdc}$ , $f = 120\text{ Hz}$	RR	–	62	–	56	62	–	dB
Dropout Voltage ( $I_O = 1.0\text{ A}$ , $T_J = 25^\circ\text{C}$ )	$V_I - V_O$	–	2.0	–	–	2.0	–	Vdc
Output Noise Voltage ( $T_A = 25^\circ\text{C}$ ) $10\text{ Hz} \leq f \leq 100\text{ kHz}$	$V_n$	–	10	–	–	10	–	$\mu\text{V}/V_O$
Output Resistance $f = 1.0\text{ kHz}$	$r_O$	–	0.9	–	–	0.9	–	$\text{m}\Omega$
Short Circuit Current Limit ( $T_A = 25^\circ\text{C}$ ) $V_{in} = 35\text{ Vdc}$	$I_{sc}$	–	0.2	–	–	0.2	–	A
Peak Output Current ( $T_J = 25^\circ\text{C}$ )	$I_{max}$	–	2.2	–	–	2.2	–	A
Average Temperature Coefficient of Output Voltage	$TCV_O$	–	–0.4	–	–	–0.4	–	$\text{mV}/^\circ\text{C}$

9.  $T_{low} = 0^\circ\text{C}$  for MC78XXC, MC78XXAC,  
=  $-40^\circ\text{C}$  for NCV78XX, MC78XXB, MC78XXAB, and MC78XXAEB

10. Load and line regulation are specified at constant junction temperature. Changes in  $V_O$  due to heating effects must be taken into account separately. Pulse testing with low duty cycle is used.

## MC7800, MC7800A, MC7800AE, NCV7800

**ELECTRICAL CHARACTERISTICS** ( $V_{in} = 14\text{ V}$ ,  $I_O = 1.0\text{ A}$ ,  $T_J = T_{low}$  to  $125^\circ\text{C}$  (Note 11), unless otherwise noted)

Characteristic	Symbol	MC7808AB/MC7808AC/NCV7808AB			Unit
		Min	Typ	Max	
Output Voltage ( $T_J = 25^\circ\text{C}$ )	$V_O$	7.84	8.0	8.16	Vdc
Output Voltage ( $5.0\text{ mA} \leq I_O \leq 1.0\text{ A}$ , $P_D \leq 15\text{ W}$ ) $10.6\text{ Vdc} \leq V_{in} \leq 23\text{ Vdc}$	$V_O$	7.7	8.0	8.3	Vdc
Line Regulation (Note 12) $10.6\text{ Vdc} \leq V_{in} \leq 25\text{ Vdc}$ , $I_O = 500\text{ mA}$ $11\text{ Vdc} \leq V_{in} \leq 17\text{ Vdc}$ , $I_O = 1.0\text{ A}$ $10.4\text{ Vdc} \leq V_{in} \leq 23\text{ Vdc}$ , $T_J = 25^\circ\text{C}$	$Reg_{line}$	–	6.0 1.7 5.0	15 18 15	mV
Load Regulation (Note 12) $5.0\text{ mA} \leq I_O \leq 1.5\text{ A}$ , $T_J = 25^\circ\text{C}$ $5.0\text{ mA} \leq I_O \leq 1.0\text{ A}$ $250\text{ mA} \leq I_O \leq 750\text{ mA}$	$Reg_{load}$	–	1.4 1.0 0.22	25 25 15	mV
Quiescent Current	$I_B$	–	3.3	6.0	mA
Quiescent Current Change $11\text{ Vdc} \leq V_{in} \leq 25\text{ Vdc}$ , $I_O = 500\text{ mA}$ $10.6\text{ Vdc} \leq V_{in} \leq 23\text{ Vdc}$ , $I_O = 1.0\text{ A}$ , $T_J = 25^\circ\text{C}$ $5.0\text{ mA} \leq I_O \leq 1.0\text{ A}$	$\Delta I_B$	–	–	0.8 0.8 0.5	mA
Ripple Rejection $11.5\text{ Vdc} \leq V_{in} \leq 21.5\text{ Vdc}$ , $f = 120\text{ Hz}$ , $I_O = 500\text{ mA}$	RR	56	62	–	dB
Dropout Voltage ( $I_O = 1.0\text{ A}$ , $T_J = 25^\circ\text{C}$ )	$V_I - V_O$	–	2.0	–	Vdc
Output Noise Voltage ( $T_A = 25^\circ\text{C}$ ) $10\text{ Hz} \leq f \leq 100\text{ kHz}$	$V_n$	–	10	–	$\mu\text{V}/V_O$
Output Resistance $f = 1.0\text{ kHz}$	$r_O$	–	0.9	–	$\text{m}\Omega$
Short Circuit Current Limit ( $T_A = 25^\circ\text{C}$ ) $V_{in} = 35\text{ Vdc}$	$I_{SC}$	–	0.2	–	A
Peak Output Current ( $T_J = 25^\circ\text{C}$ )	$I_{max}$	–	2.2	–	A
Average Temperature Coefficient of Output Voltage	$TCV_O$	–	–0.4	–	$\text{mV}/^\circ\text{C}$

11.  $T_{low} = 0^\circ\text{C}$  for MC78XXC, MC78XXAC,  
=  $-40^\circ\text{C}$  for NCV78XX, MC78XXB, MC78XXAB, and MC78XXAEB

12. Load and line regulation are specified at constant junction temperature. Changes in  $V_O$  due to heating effects must be taken into account separately. Pulse testing with low duty cycle is used.



# MC7800, MC7800A, MC7800AE, NCV7800

**ELECTRICAL CHARACTERISTICS** ( $V_{in} = 15\text{ V}$ ,  $I_O = 500\text{ mA}$ ,  $T_J = T_{low}$  to  $125^\circ\text{C}$  (Note 13), unless otherwise noted)

Characteristic	Symbol	MC7809B/NCV7809B			MC7809C			Unit
		Min	Typ	Max	Min	Typ	Max	
Output Voltage ( $T_J = 25^\circ\text{C}$ )	$V_O$	8.65	9.0	9.35	8.65	9.0	9.35	Vdc
Output Voltage ( $5.0\text{ mA} \leq I_O \leq 1.0\text{ A}$ , $P_D \leq 15\text{ W}$ ) $11.5\text{ Vdc} \leq V_{in} \leq 24\text{ Vdc}$	$V_O$	8.55	9.0	9.45	8.55	9.0	9.45	Vdc
Line Regulation, $T_J = 25^\circ\text{C}$ (Note 14) $11\text{ Vdc} \leq V_{in} \leq 26\text{ Vdc}$ $11.5\text{ Vdc} \leq V_{in} \leq 17\text{ Vdc}$	$Reg_{line}$	–	6.2	32	–	6.2	32	mV
Load Regulation, $T_J = 25^\circ\text{C}$ (Note 14) $5.0\text{ mA} \leq I_O \leq 1.5\text{ A}$	$Reg_{load}$	–	1.5	35	–	1.5	35	mV
Quiescent Current	$I_B$	–	3.4	8.0	–	3.4	8.0	mA
Quiescent Current Change $11.5\text{ Vdc} \leq V_{in} \leq 26\text{ Vdc}$ $5.0\text{ mA} \leq I_O \leq 1.0\text{ A}$	$\Delta I_B$	–	–	1.0	–	–	1.0	mA
Ripple Rejection $11.5\text{ Vdc} \leq V_{in} \leq 21.5\text{ Vdc}$ , $f = 120\text{ Hz}$	RR	56	61	–	56	61	–	dB
Dropout Voltage ( $I_O = 1.0\text{ A}$ , $T_J = 25^\circ\text{C}$ )	$V_I - V_O$	–	2.0	–	–	2.0	–	Vdc
Output Noise Voltage ( $T_A = 25^\circ\text{C}$ ) $10\text{ Hz} \leq f \leq 100\text{ kHz}$	$V_n$	–	10	–	–	10	–	$\mu\text{V}/V_O$
Output Resistance $f = 1.0\text{ kHz}$	$r_O$	–	1.0	–	–	1.0	–	$\text{m}\Omega$
Short Circuit Current Limit ( $T_A = 25^\circ\text{C}$ ) $V_{in} = 35\text{ Vdc}$	$I_{SC}$	–	0.2	–	–	0.2	–	A
Peak Output Current ( $T_J = 25^\circ\text{C}$ )	$I_{max}$	–	2.2	–	–	2.2	–	A
Average Temperature Coefficient of Output Voltage	$TCV_O$	–	–0.5	–	–	–0.5	–	$\text{mV}/^\circ\text{C}$

13.  $T_{low} = 0^\circ\text{C}$  for MC78XXC, MC78XXAC,  
=  $-40^\circ\text{C}$  for NCV78XX, MC78XXB, MC78XXAB, and MC78XXAEB

14. Load and line regulation are specified at constant junction temperature. Changes in  $V_O$  due to heating effects must be taken into account separately. Pulse testing with low duty cycle is used.

# MC7800, MC7800A, MC7800AE, NCV7800

## ELECTRICAL CHARACTERISTICS ( $V_{in} = 15\text{ V}$ , $I_O = 1.0\text{ A}$ , $T_J = T_{low}$ to $125^\circ\text{C}$ (Note 15), unless otherwise noted)

Characteristic	Symbol	MC7809AB/MC7809AC			Unit
		Min	Typ	Max	
Output Voltage ( $T_J = 25^\circ\text{C}$ )	$V_O$	8.82	9.0	9.18	Vdc
Output Voltage ( $5.0\text{ mA} \leq I_O \leq 1.0\text{ A}$ , $P_D \leq 15\text{ W}$ ) $11.5\text{ Vdc} \leq V_{in} \leq 24\text{ Vdc}$	$V_O$	8.65	9.0	9.35	Vdc
Line Regulation (Note 16) $11.5\text{ Vdc} \leq V_{in} \leq 26\text{ Vdc}$ , $I_O = 500\text{ mA}$ $12\text{ Vdc} \leq V_{in} \leq 17\text{ Vdc}$ , $I_O = 1.0\text{ A}$ $11.5\text{ Vdc} \leq V_{in} \leq 24\text{ Vdc}$ , $T_J = 25^\circ\text{C}$	Regline	–	6.2 1.8 5.2	16 7.0 16	mV
Load Regulation (Note 16) $5.0\text{ mA} \leq I_O \leq 1.5\text{ A}$ , $T_J = 25^\circ\text{C}$ $5.0\text{ mA} \leq I_O \leq 1.0\text{ A}$ $250\text{ mA} \leq I_O \leq 750\text{ mA}$	Regload	–	–	25 25 15	mV
Quiescent Current	$I_B$	–	3.3	6.0	mA
Quiescent Current Change $11.5\text{ Vdc} \leq V_{in} \leq 26\text{ Vdc}$ , $I_O = 500\text{ mA}$ $11.5\text{ Vdc} \leq V_{in} \leq 24\text{ Vdc}$ , $I_O = 1.0\text{ A}$ , $T_J = 25^\circ\text{C}$ $5.0\text{ mA} \leq I_O \leq 1.0\text{ A}$	$\Delta I_B$	–	–	0.8 0.8 0.5	mA
Ripple Rejection $11.5\text{ Vdc} \leq V_{in} \leq 21.5\text{ Vdc}$ , $f = 120\text{ Hz}$ , $I_O = 500\text{ mA}$	RR	56	61	–	dB
Dropout Voltage ( $I_O = 1.0\text{ A}$ , $T_J = 25^\circ\text{C}$ )	$V_{I\_VO}$		2.0		Vdc
Output Noise Voltage ( $T_A = 25^\circ\text{C}$ ) $10\text{ Hz} \leq f \leq 100\text{ kHz}$	$V_n$	–	10	–	$\mu\text{V}/V_O$
Output Resistance $f = 1.0\text{ kHz}$	$r_O$	–	1.0	–	$\text{m}\Omega$
Short Circuit Current Limit ( $T_A = 25^\circ\text{C}$ ) $V_{in} = 35\text{ Vdc}$	$I_{SC}$	–	0.2	–	A
Peak Output Current ( $T_J = 25^\circ\text{C}$ )	$I_{max}$	–	2.2	–	A
Average Temperature Coefficient of Output Voltage	TCVO	–	–0.5	–	$\text{mV}/^\circ\text{C}$

15.  $T_{low} = 0^\circ\text{C}$  for MC78XXC, MC78XXAC,  
=  $-40^\circ\text{C}$  for NCV78XX, MC78XXB, MC78XXAB.

16. Load and line regulation are specified at constant junction temperature. Changes in  $V_O$  due to heating effects must be taken into account separately. Pulse testing with low duty cycle is used.

# MC7800, MC7800A, MC7800AE, NCV7800

**ELECTRICAL CHARACTERISTICS** ( $V_{in} = 19\text{ V}$ ,  $I_O = 500\text{ mA}$ ,  $T_J = T_{low}$  to  $125^\circ\text{C}$  (Note 17), unless otherwise noted)

Characteristic	Symbol	MC7812B/NCV7812B			MC7812C			Unit
		Min	Typ	Max	Min	Typ	Max	
Output Voltage ( $T_J = 25^\circ\text{C}$ )	$V_O$	11.5	12	12.5	11.5	12	12.5	Vdc
Output Voltage ( $5.0\text{ mA} \leq I_O \leq 1.0\text{ A}$ , $P_D \leq 15\text{ W}$ ) $14.5\text{ Vdc} \leq V_{in} \leq 27\text{ Vdc}$ $15.5\text{ Vdc} \leq V_{in} \leq 27\text{ Vdc}$	$V_O$	– 11.4	– 12	– 12.6	11.4 –	12 –	12.6 –	Vdc
Line Regulation, $T_J = 25^\circ\text{C}$ (Note 18) $14.5\text{ Vdc} \leq V_{in} \leq 30\text{ Vdc}$ $16\text{ Vdc} \leq V_{in} \leq 22\text{ Vdc}$ $14.8\text{ Vdc} \leq V_{in} \leq 27\text{ Vdc}$ , $I_O = 1.0\text{ A}$	$Reg_{line}$	– – –	7.5 2.2 –	240 120 –	– – –	3.8 0.3 –	24 24 48	mV
Load Regulation, $T_J = 25^\circ\text{C}$ (Note 18) $5.0\text{ mA} \leq I_O \leq 1.5\text{ A}$	$Reg_{load}$	–	1.6	240	–	8.1	60	mV
Quiescent Current	$I_B$	–	3.4	8.0	–	3.4	6.5	mA
Quiescent Current Change $14.5\text{ Vdc} \leq V_{in} \leq 30\text{ Vdc}$ , $I_O = 1.0\text{ A}$ , $T_J = 25^\circ\text{C}$ $15\text{ Vdc} \leq V_{in} \leq 30\text{ Vdc}$ $5.0\text{ mA} \leq I_O \leq 1.0\text{ A}$	$\Delta I_B$	– – –	– – –	– 1.0 0.5	– – –	– – –	0.7 0.8 0.5	mA
Ripple Rejection $15\text{ Vdc} \leq V_{in} \leq 25\text{ Vdc}$ , $f = 120\text{ Hz}$	RR	–	60	–	55	60	–	dB
Dropout Voltage ( $I_O = 1.0\text{ A}$ , $T_J = 25^\circ\text{C}$ )	$V_I - V_O$	–	2.0	–	–	2.0	–	Vdc
Output Noise Voltage ( $T_A = 25^\circ\text{C}$ ) $10\text{ Hz} \leq f \leq 100\text{ kHz}$	$V_n$	–	10	–	–	10	–	$\mu\text{V}/V_O$
Output Resistance $f = 1.0\text{ kHz}$	$r_O$	–	1.1	–	–	1.1	–	$\text{m}\Omega$
Short Circuit Current Limit ( $T_A = 25^\circ\text{C}$ ) $V_{in} = 35\text{ Vdc}$	$I_{sc}$	–	0.2	–	–	0.2	–	A
Peak Output Current ( $T_J = 25^\circ\text{C}$ )	$I_{max}$	–	2.2	–	–	2.2	–	A
Average Temperature Coefficient of Output Voltage	$TCV_O$	–	–0.8	–	–	–0.8	–	$\text{mV}/^\circ\text{C}$

17.  $T_{low} = 0^\circ\text{C}$  for MC78XXC, MC78XXAC,  
 $= -40^\circ\text{C}$  for NCV78XX, MC78XXB, MC78XXAB, and MC78XXAEB

18. Load and line regulation are specified at constant junction temperature. Changes in  $V_O$  due to heating effects must be taken into account separately. Pulse testing with low duty cycle is used.

# MC7800, MC7800A, MC7800AE, NCV7800

## ELECTRICAL CHARACTERISTICS ( $V_{in} = 19\text{ V}$ , $I_O = 1.0\text{ A}$ , $T_J = T_{low}$ to $125^\circ\text{C}$ (Note 19), unless otherwise noted)

Characteristic	Symbol	MC7812AB/MC7812AC/NCV7812AB			Unit
		Min	Typ	Max	
Output Voltage ( $T_J = 25^\circ\text{C}$ )	$V_O$	11.75	12	12.25	Vdc
Output Voltage ( $5.0\text{ mA} \leq I_O \leq 1.0\text{ A}$ , $P_D \leq 15\text{ W}$ ) $14.8\text{ Vdc} \leq V_{in} \leq 27\text{ Vdc}$	$V_O$	11.5	12	12.5	Vdc
Line Regulation (Note 20) $14.8\text{ Vdc} \leq V_{in} \leq 30\text{ Vdc}$ , $I_O = 500\text{ mA}$ $16\text{ Vdc} \leq V_{in} \leq 22\text{ Vdc}$ , $I_O = 1.0\text{ A}$ $14.5\text{ Vdc} \leq V_{in} \leq 27\text{ Vdc}$ , $T_J = 25^\circ\text{C}$	$Reg_{line}$	–	3.8 2.2 6.0	18 20 120	mV
Load Regulation (Note 20) $5.0\text{ mA} \leq I_O \leq 1.5\text{ A}$ , $T_J = 25^\circ\text{C}$ $5.0\text{ mA} \leq I_O \leq 1.0\text{ A}$	$Reg_{load}$	–	–	25 25	mV
Quiescent Current	$I_B$	–	3.4	6.0	mA
Quiescent Current Change $15\text{ Vdc} \leq V_{in} \leq 30\text{ Vdc}$ , $I_O = 500\text{ mA}$ $14.8\text{ Vdc} \leq V_{in} \leq 27\text{ Vdc}$ , $T_J = 25^\circ\text{C}$ $5.0\text{ mA} \leq I_O \leq 1.0\text{ A}$ , $T_J = 25^\circ\text{C}$	$\Delta I_B$	–	–	0.8 0.8 0.5	mA
Ripple Rejection $15\text{ Vdc} \leq V_{in} \leq 25\text{ Vdc}$ , $f = 120\text{ Hz}$ , $I_O = 500\text{ mA}$	RR	55	60	–	dB
Dropout Voltage ( $I_O = 1.0\text{ A}$ , $T_J = 25^\circ\text{C}$ )	$V_I - V_O$	–	2.0	–	Vdc
Output Noise Voltage ( $T_A = 25^\circ\text{C}$ ) $10\text{ Hz} \leq f \leq 100\text{ kHz}$	$V_n$	–	10	–	$\mu\text{V}/V_O$
Output Resistance ( $f = 1.0\text{ kHz}$ )	$r_O$	–	1.1	–	$\text{m}\Omega$
Short Circuit Current Limit ( $T_A = 25^\circ\text{C}$ ) $V_{in} = 35\text{ Vdc}$	$I_{sc}$	–	0.2	–	A
Peak Output Current ( $T_J = 25^\circ\text{C}$ )	$I_{max}$	–	2.2	–	A
Average Temperature Coefficient of Output Voltage	$TCV_O$	–	–0.8	–	$\text{mV}/^\circ\text{C}$

19.  $T_{low} = 0^\circ\text{C}$  for MC78XXC, MC78XXAC,  
=  $-40^\circ\text{C}$  for NCV78XX, MC78XXB, MC78XXAB, and MC78XXAEB

20. Load and line regulation are specified at constant junction temperature. Changes in  $V_O$  due to heating effects must be taken into account separately. Pulse testing with low duty cycle is used.

# MC7800, MC7800A, MC7800AE, NCV7800

**ELECTRICAL CHARACTERISTICS** ( $V_{in} = 23\text{ V}$ ,  $I_O = 500\text{ mA}$ ,  $T_J = T_{low}$  to  $125^\circ\text{C}$  (Note 21), unless otherwise noted)

Characteristic	Symbol	MC7815B/NCV7815B			MC7815C			Unit
		Min	Typ	Max	Min	Typ	Max	
Output Voltage ( $T_J = 25^\circ\text{C}$ )	$V_O$	14.4	15	15.6	14.4	15	15.6	Vdc
Output Voltage ( $5.0\text{ mA} \leq I_O \leq 1.0\text{ A}$ , $P_D \leq 15\text{ W}$ ) $17.5\text{ Vdc} \leq V_{in} \leq 30\text{ Vdc}$ $18.5\text{ Vdc} \leq V_{in} \leq 30\text{ Vdc}$	$V_O$	– 14.25	– 15	– 15.75	14.25 –	15 –	15.75 –	Vdc
Line Regulation, $T_J = 25^\circ\text{C}$ (Note 22) $17.9\text{ Vdc} \leq V_{in} \leq 30\text{ Vdc}$ $20\text{ Vdc} \leq V_{in} \leq 26\text{ Vdc}$	$Reg_{line}$	– –	8.5 3.0	300 150	– –	8.5 3.0	30 28	mV
Load Regulation, $T_J = 25^\circ\text{C}$ (Note 22) $5.0\text{ mA} \leq I_O \leq 1.5\text{ A}$	$Reg_{load}$	–	1.8	300	–	1.8	55	mV
Quiescent Current	$I_B$	–	3.5	8.0	–	3.5	6.5	mA
Quiescent Current Change $17.5\text{ Vdc} \leq V_{in} \leq 30\text{ Vdc}$ $17.5\text{ Vdc} \leq V_{in} \leq 30\text{ Vdc}$ , $I_O = 1.0\text{ A}$ , $T_J = 25^\circ\text{C}$ $5.0\text{ mA} \leq I_O \leq 1.0\text{ A}$	$\Delta I_B$	– – –	– – –	– 1.0 0.5	– – –	– – –	0.8 0.7 0.5	mA
Ripple Rejection $18.5\text{ Vdc} \leq V_{in} \leq 28.5\text{ Vdc}$ , $f = 120\text{ Hz}$	RR	–	58	–	54	58	–	dB
Dropout Voltage ( $I_O = 1.0\text{ A}$ , $T_J = 25^\circ\text{C}$ )	$V_I - V_O$	–	2.0	–	–	2.0	–	Vdc
Output Noise Voltage ( $T_A = 25^\circ\text{C}$ ) $10\text{ Hz} \leq f \leq 100\text{ kHz}$	$V_n$	–	10	–	–	10	–	$\mu\text{V}/V_O$
Output Resistance $f = 1.0\text{ kHz}$	$r_O$	–	1.2	–	–	1.2	–	$\text{m}\Omega$
Short Circuit Current Limit ( $T_A = 25^\circ\text{C}$ ) $V_{in} = 35\text{ Vdc}$	$I_{SC}$	–	0.2	–	–	0.2	–	A
Peak Output Current ( $T_J = 25^\circ\text{C}$ )	$I_{max}$	–	2.2	–	–	2.2	–	A
Average Temperature Coefficient of Output Voltage	$TCV_O$	–	–1.0	–	–	–1.0	–	$\text{mV}/^\circ\text{C}$

21.  $T_{low} = 0^\circ\text{C}$  for MC78XXC, MC78XXAC,  
=  $-40^\circ\text{C}$  for NCV78XX, MC78XXB, MC78XXAB, and MC78XXAEB

22. Load and line regulation are specified at constant junction temperature. Changes in  $V_O$  due to heating effects must be taken into account separately. Pulse testing with low duty cycle is used.

# MC7800, MC7800A, MC7800AE, NCV7800

## ELECTRICAL CHARACTERISTICS ( $V_{in} = 23\text{ V}$ , $I_O = 1.0\text{ A}$ , $T_J = T_{low}$ to $125^\circ\text{C}$ (Note 23), unless otherwise noted)

Characteristic	Symbol	MC7815AB/MC7815AC			Unit
		Min	Typ	Max	
Output Voltage ( $T_J = 25^\circ\text{C}$ )	$V_O$	14.7	15	15.3	Vdc
Output Voltage ( $5.0\text{ mA} \leq I_O \leq 1.0\text{ A}$ , $P_D \leq 15\text{ W}$ ) $17.9\text{ Vdc} \leq V_{in} \leq 30\text{ Vdc}$	$V_O$	14.4	15	15.6	Vdc
Line Regulation (Note 24) $17.9\text{ Vdc} \leq V_{in} \leq 30\text{ Vdc}$ , $I_O = 500\text{ mA}$ $20\text{ Vdc} \leq V_{in} \leq 26\text{ Vdc}$ $17.5\text{ Vdc} \leq V_{in} \leq 30\text{ Vdc}$ , $I_O = 1.0\text{ A}$ , $T_J = 25^\circ\text{C}$	$Reg_{line}$	–	8.5 3.0 7.0	20 22 20	mV
Load Regulation (Note 24) $5.0\text{ mA} \leq I_O \leq 1.5\text{ A}$ , $T_J = 25^\circ\text{C}$ $5.0\text{ mA} \leq I_O \leq 1.0\text{ A}$ $250\text{ mA} \leq I_O \leq 750\text{ mA}$	$Reg_{load}$	–	1.8 1.5 1.2	25 25 15	mV
Quiescent Current	$I_B$	–	3.5	6.0	mA
Quiescent Current Change $17.5\text{ Vdc} \leq V_{in} \leq 30\text{ Vdc}$ , $I_O = 500\text{ mA}$ $17.5\text{ Vdc} \leq V_{in} \leq 30\text{ Vdc}$ , $I_O = 1.0\text{ A}$ , $T_J = 25^\circ\text{C}$ $5.0\text{ mA} \leq I_O \leq 1.0\text{ A}$	$\Delta I_B$	–	–	0.8 0.8 0.5	mA
Ripple Rejection $18.5\text{ Vdc} \leq V_{in} \leq 28.5\text{ Vdc}$ , $f = 120\text{ Hz}$ , $I_O = 500\text{ mA}$	RR	60	80	–	dB
Dropout Voltage ( $I_O = 1.0\text{ A}$ , $T_J = 25^\circ\text{C}$ )	$V_I - V_O$	–	2.0	–	Vdc
Output Noise Voltage ( $T_A = 25^\circ\text{C}$ ) $10\text{ Hz} \leq f \leq 100\text{ kHz}$	$V_n$	–	10	–	$\mu\text{V}/V_O$
Output Resistance $f = 1.0\text{ kHz}$	$r_O$	–	1.2	–	$\text{m}\Omega$
Short Circuit Current Limit ( $T_A = 25^\circ\text{C}$ ) $V_{in} = 35\text{ Vdc}$	$I_{SC}$	–	0.2	–	A
Peak Output Current ( $T_J = 25^\circ\text{C}$ )	$I_{max}$	–	2.2	–	A
Average Temperature Coefficient of Output Voltage	$TCV_O$	–	–1.0	–	$\text{mV}/^\circ\text{C}$

23.  $T_{low} = 0^\circ\text{C}$  for MC78XXC, MC78XXAC,  
 $= -40^\circ\text{C}$  for NCV78XX, MC78XXB, MC78XXAB, and MC78XXAEB

24. Load and line regulation are specified at constant junction temperature. Changes in  $V_O$  due to heating effects must be taken into account separately. Pulse testing with low duty cycle is used.

## MC7800, MC7800A, MC7800AE, NCV7800

**ELECTRICAL CHARACTERISTICS** ( $V_{in} = 27\text{ V}$ ,  $I_O = 500\text{ mA}$ ,  $T_J = T_{low}$  to  $125^\circ\text{C}$  (Note 25), unless otherwise noted)

Characteristic	Symbol	MC7818B			MC7818C			Unit
		Min	Typ	Max	Min	Typ	Max	
Output Voltage ( $T_J = 25^\circ\text{C}$ )	$V_O$	17.3	18	18.7	17.3	18	18.7	Vdc
Output Voltage ( $5.0\text{ mA} \leq I_O \leq 1.0\text{ A}$ , $P_D \leq 15\text{ W}$ ) $21\text{ Vdc} \leq V_{in} \leq 33\text{ Vdc}$ $22\text{ Vdc} \leq V_{in} \leq 33\text{ Vdc}$	$V_O$	– 17.1	– 18	– 18.9	17.1 –	18 –	18.9 –	Vdc
Line Regulation, (Note 26) $21\text{ Vdc} \leq V_{in} \leq 33\text{ Vdc}$ $24\text{ Vdc} \leq V_{in} \leq 33\text{ Vdc}$	$Reg_{line}$	– –	9.5 3.2	360 180	– –	9.5 3.2	50 25	mV
Load Regulation, (Note 26) $5.0\text{ mA} \leq I_O \leq 1.5\text{ A}$	$Reg_{load}$	–	2.0	360	–	2.0	55	mV
Quiescent Current	$I_B$	–	3.5	8.0	–	3.5	6.5	mA
Quiescent Current Change $21\text{ Vdc} \leq V_{in} \leq 33\text{ Vdc}$ $5.0\text{ mA} \leq I_O \leq 1.0\text{ A}$	$\Delta I_B$	– –	– –	– 0.5	– –	– –	1.0 0.5	mA
Ripple Rejection $22\text{ Vdc} \leq V_{in} \leq 33\text{ Vdc}$ , $f = 120\text{ Hz}$	RR	–	57	–	53	57	–	dB
Dropout Voltage ( $I_O = 1.0\text{ A}$ , $T_J = 25^\circ\text{C}$ )	$V_{il} - V_O$	–	2.0	–	–	2.0	–	Vdc
Output Noise Voltage ( $T_A = 25^\circ\text{C}$ ) $10\text{ Hz} \leq f \leq 100\text{ kHz}$	$V_n$	–	10	–	–	10	–	$\mu\text{V}/V_O$
Output Resistance $f = 1.0\text{ kHz}$	$r_O$	–	1.3	–	–	1.3	–	$\text{m}\Omega$
Short Circuit Current Limit ( $T_A = 25^\circ\text{C}$ ) $V_{in} = 35\text{ Vdc}$	$I_{SC}$	–	0.2	–	–	0.2	–	A
Peak Output Current ( $T_J = 25^\circ\text{C}$ )	$I_{max}$	–	2.2	–	–	2.2	–	A
Average Temperature Coefficient of Output Voltage	$TCV_O$	–	–1.5	–	–	–1.5	–	$\text{mV}/^\circ\text{C}$

25.  $T_{low} = 0^\circ\text{C}$  for MC78XXC, MC78XXAC,  
 $= -40^\circ\text{C}$  for NCV78XX, MC78XXB, MC78XXAB, and MC78XXAEB

26. Load and line regulation are specified at constant junction temperature. Changes in  $V_O$  due to heating effects must be taken into account separately. Pulse testing with low duty cycle is used.

# MC7800, MC7800A, MC7800AE, NCV7800

## ELECTRICAL CHARACTERISTICS ( $V_{in} = 27\text{ V}$ , $I_O = 1.0\text{ A}$ , $T_J = T_{low}$ to $125^\circ\text{C}$ (Note 27), unless otherwise noted)

Characteristic	Symbol	MC7818AC			Unit
		Min	Typ	Max	
Output Voltage ( $T_J = 25^\circ\text{C}$ )	$V_O$	17.64	18	18.36	Vdc
Output Voltage ( $5.0\text{ mA} \leq I_O \leq 1.0\text{ A}$ , $P_D \leq 15\text{ W}$ ) $21\text{ Vdc} \leq V_{in} \leq 33\text{ Vdc}$	$V_O$	17.3	18	18.7	Vdc
Line Regulation (Note 28) $21\text{ Vdc} \leq V_{in} \leq 33\text{ Vdc}$ , $I_O = 500\text{ mA}$ $24\text{ Vdc} \leq V_{in} \leq 30\text{ Vdc}$ , $I_O = 1.0\text{ A}$ $24\text{ Vdc} \leq V_{in} \leq 30\text{ Vdc}$ , $I_O = 1.0\text{ A}$ , $T_J = 25^\circ\text{C}$ $20.6\text{ Vdc} \leq V_{in} \leq 33\text{ Vdc}$ , $I_O = 1.0\text{ A}$ , $T_J = 25^\circ\text{C}$	$Reg_{line}$	–	9.5 3.2 3.2 8.0	22 25 10.5 22	mV
Load Regulation (Note 28) $5.0\text{ mA} \leq I_O \leq 1.5\text{ A}$ , $T_J = 25^\circ\text{C}$ $5.0\text{ mA} \leq I_O \leq 1.0\text{ A}$ $250\text{ mA} \leq I_O \leq 750\text{ mA}$	$Reg_{load}$	–	2.0 1.8 1.5	25 25 15	mV
Quiescent Current	$I_B$	–	3.5	6.0	mA
Quiescent Current Change $21\text{ Vdc} \leq V_{in} \leq 33\text{ Vdc}$ , $I_O = 500\text{ mA}$ $21.5\text{ Vdc} \leq V_{in} \leq 30\text{ Vdc}$ , $T_J = 25^\circ\text{C}$ $5.0\text{ mA} \leq I_O \leq 1.0\text{ A}$	$\Delta I_B$	–	–	0.8 0.8 0.5	mA
Ripple Rejection $22\text{ Vdc} \leq V_{in} \leq 32\text{ Vdc}$ , $f = 120\text{ Hz}$ , $I_O = 500\text{ mA}$	RR	53	57	–	dB
Dropout Voltage ( $I_O = 1.0\text{ A}$ , $T_J = 25^\circ\text{C}$ )	$V_I - V_O$	–	2.0	–	Vdc
Output Noise Voltage ( $T_A = 25^\circ\text{C}$ ) $10\text{ Hz} \leq f \leq 100\text{ kHz}$	$V_n$	–	10	–	$\mu\text{V}/V_O$
Output Resistance $f = 1.0\text{ kHz}$	$r_O$	–	1.3	–	$\text{m}\Omega$
Short Circuit Current Limit ( $T_A = 25^\circ\text{C}$ ) $V_{in} = 35\text{ Vdc}$	$I_{sc}$	–	0.2	–	A
Peak Output Current ( $T_J = 25^\circ\text{C}$ )	$I_{max}$	–	2.2	–	A
Average Temperature Coefficient of Output Voltage	$TCV_O$	–	–1.5	–	$\text{mV}/^\circ\text{C}$

27.  $T_{low} = 0^\circ\text{C}$  for MC78XXC, MC78XXAC,  
=  $-40^\circ\text{C}$  for NCV78XX, MC78XXB, MC78XXAB, and MC78XXAEB

28. Load and line regulation are specified at constant junction temperature. Changes in  $V_O$  due to heating effects must be taken into account separately. Pulse testing with low duty cycle is used.



## MC7800, MC7800A, MC7800AE, NCV7800

**ELECTRICAL CHARACTERISTICS** ( $V_{in} = 33\text{ V}$ ,  $I_O = 500\text{ mA}$ ,  $T_J = T_{low}$  to  $125^\circ\text{C}$  (Note 29), unless otherwise noted)

Characteristic	Symbol	MC7824B			MC7824C			Unit
		Min	Typ	Max	Min	Typ	Max	
Output Voltage ( $T_J = 25^\circ\text{C}$ )	$V_O$	23	24	25	23	24	25	Vdc
Output Voltage ( $5.0\text{ mA} \leq I_O \leq 1.0\text{ A}$ , $P_D \leq 15\text{ W}$ ) $27\text{ Vdc} \leq V_{in} \leq 38\text{ Vdc}$ $28\text{ Vdc} \leq V_{in} \leq 38\text{ Vdc}$	$V_O$	– 22.8	– 24	– 25.2	22.8 –	24 –	25.2 –	Vdc
Line Regulation, (Note 30) $27\text{ Vdc} \leq V_{in} \leq 38\text{ Vdc}$ $30\text{ Vdc} \leq V_{in} \leq 38\text{ Vdc}$	$Reg_{line}$	– –	11.5 3.8	480 240	– –	2.7 2.7	60 48	mV
Load Regulation, (Note 30) $5.0\text{ mA} \leq I_O \leq 1.5\text{ A}$	$Reg_{load}$	–	2.1	480	–	4.4	65	mV
Quiescent Current	$I_B$	–	3.6	8.0	–	3.6	6.5	mA
Quiescent Current Change $27\text{ Vdc} \leq V_{in} \leq 38\text{ Vdc}$ $5.0\text{ mA} \leq I_O \leq 1.0\text{ A}$	$\Delta I_B$	– –	– –	– 0.5	– –	– –	1.0 0.5	mA
Ripple Rejection $28\text{ Vdc} \leq V_{in} \leq 38\text{ Vdc}$ , $f = 120\text{ Hz}$	RR	–	54	–	50	54	–	dB
Dropout Voltage ( $I_O = 1.0\text{ A}$ , $T_J = 25^\circ\text{C}$ )	$V_I - V_O$	–	2.0	–	–	2.0	–	Vdc
Output Noise Voltage ( $T_A = 25^\circ\text{C}$ ) $10\text{ Hz} \leq f \leq 100\text{ kHz}$	$V_n$	–	10	–	–	10	–	$\mu\text{V}/V_O$
Output Resistance $f = 1.0\text{ kHz}$	$r_O$	–	1.4	–	–	1.4	–	$\text{m}\Omega$
Short Circuit Current Limit ( $T_A = 25^\circ\text{C}$ ) $V_{in} = 35\text{ Vdc}$	$I_{sc}$	–	0.2	–	–	0.2	–	A
Peak Output Current ( $T_J = 25^\circ\text{C}$ )	$I_{max}$	–	2.2	–	–	2.2	–	A
Average Temperature Coefficient of Output Voltage	$TCV_O$	–	–2.0	–	–	–2.0	–	$\text{mV}/^\circ\text{C}$

29.  $T_{low} = 0^\circ\text{C}$  for MC78XXC, MC78XXAC,  
=  $-40^\circ\text{C}$  for NCV78XX, MC78XXB, MC78XXAB, and MC78XXAEB

30. Load and line regulation are specified at constant junction temperature. Changes in  $V_O$  due to heating effects must be taken into account separately. Pulse testing with low duty cycle is used.

# MC7800, MC7800A, MC7800AE, NCV7800

## ELECTRICAL CHARACTERISTICS ( $V_{in} = 33\text{ V}$ , $I_O = 1.0\text{ A}$ , $T_J = T_{low}$ to $125^\circ\text{C}$ (Note 31), unless otherwise noted)

Characteristic	Symbol	MC7824AC			Unit
		Min	Typ	Max	
Output Voltage ( $T_J = 25^\circ\text{C}$ )	$V_O$	23.5	24	24.5	Vdc
Output Voltage ( $5.0\text{ mA} \leq I_O \leq 1.0\text{ A}$ , $P_D \leq 15\text{ W}$ ) $27.3\text{ Vdc} \leq V_{in} \leq 38\text{ Vdc}$	$V_O$	23.2	24	25.8	Vdc
Line Regulation (Note 32) $27\text{ Vdc} \leq V_{in} \leq 38\text{ Vdc}$ , $I_O = 500\text{ mA}$ $30\text{ Vdc} \leq V_{in} \leq 36\text{ Vdc}$ , $I_O = 1.0\text{ A}$ $30\text{ Vdc} \leq V_{in} \leq 36\text{ Vdc}$ , $T_J = 25^\circ\text{C}$ $26.7\text{ Vdc} \leq V_{in} \leq 38\text{ Vdc}$ , $I_O = 1.0\text{ A}$ , $T_J = 25^\circ\text{C}$	$Reg_{line}$	–	11.5 3.8 3.8 10	25 28 12 25	mV
Load Regulation (Note 32) $5.0\text{ mA} \leq I_O \leq 1.5\text{ A}$ , $T_J = 25^\circ\text{C}$ $5.0\text{ mA} \leq I_O \leq 1.0\text{ A}$ $250\text{ mA} \leq I_O \leq 750\text{ mA}$	$Reg_{load}$	–	2.1 2.0 1.8	15 25 15	mV
Quiescent Current	$I_B$	–	3.6	6.0	mA
Quiescent Current Change $27.3\text{ Vdc} \leq V_{in} \leq 38\text{ Vdc}$ , $I_O = 500\text{ mA}$ $27\text{ Vdc} \leq V_{in} \leq 38\text{ Vdc}$ , $T_J = 25^\circ\text{C}$ $5.0\text{ mA} \leq I_O \leq 1.0\text{ A}$	$\Delta I_B$	–	–	0.8 0.8 0.5	mA
Ripple Rejection $28\text{ Vdc} \leq V_{in} \leq 38\text{ Vdc}$ , $f = 120\text{ Hz}$ , $I_O = 500\text{ mA}$	RR	45	54	–	dB
Dropout Voltage ( $I_O = 1.0\text{ A}$ , $T_J = 25^\circ\text{C}$ )	$V_I - V_O$	–	2.0	–	Vdc
Output Noise Voltage ( $T_A = 25^\circ\text{C}$ ) $10\text{ Hz} \leq f \leq 100\text{ kHz}$	$V_n$	–	10	–	$\mu\text{V}/V_O$
Output Resistance ( $f = 1.0\text{ kHz}$ )	$r_O$	–	1.4	–	$\text{m}\Omega$
Short Circuit Current Limit ( $T_A = 25^\circ\text{C}$ ) $V_{in} = 35\text{ Vdc}$	$I_{sc}$	–	0.2	–	A
Peak Output Current ( $T_J = 25^\circ\text{C}$ )	$I_{max}$	–	2.2	–	A
Average Temperature Coefficient of Output Voltage	$TCV_O$	–	–2.0	–	$\text{mV}/^\circ\text{C}$

31.  $T_{low} = 0^\circ\text{C}$  for MC78XXC, MC78XXAC,  
 $= -40^\circ\text{C}$  for NCV78XX, MC78XXB, MC78XXAB, and MC78XXAEB

32. Load and line regulation are specified at constant junction temperature. Changes in  $V_O$  due to heating effects must be taken into account separately. Pulse testing with low duty cycle is used.

# MC7800, MC7800A, MC7800AE, NCV7800

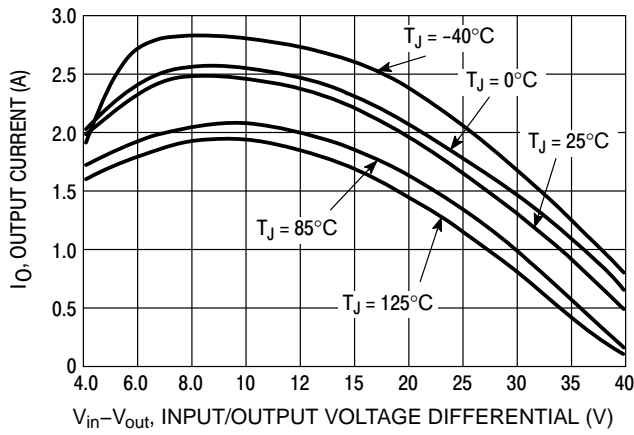

**Figure 2. Peak Output Current as a Function of Input/Output Differential Voltage (MC78XXC, AC, B)**



**Figure 3. Ripple Rejection as a Function of Output Voltages (MC78XXC, AC, B)**

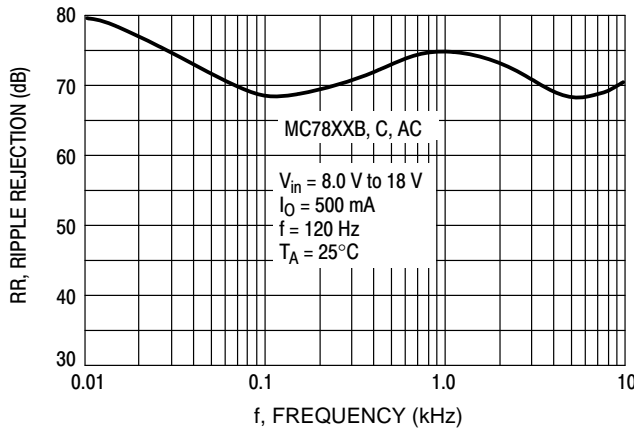

**Figure 4. Ripple Rejection as a Function of Frequency (MC78XXC, AC, B)**

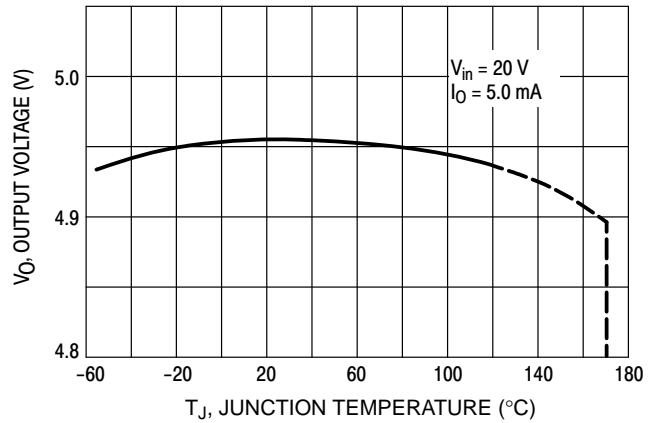

**Figure 5. Output Voltage as a Function of Junction Temperature (MC7805C, AC, B)**

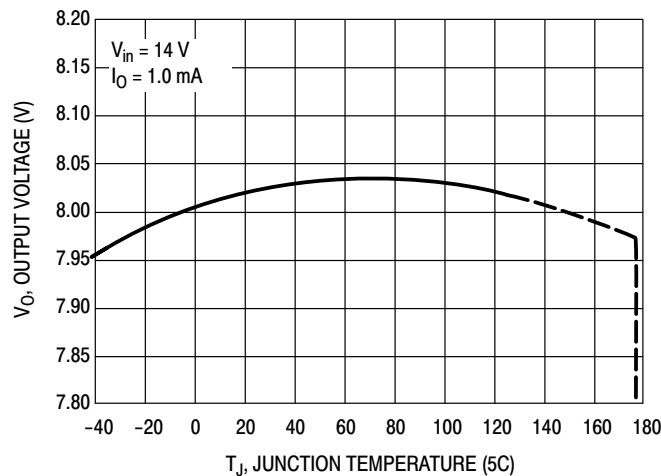

**Figure 6. Output Voltage as a Function of Junction Temperature (MC7808AE)**

# MC7800, MC7800A, MC7800AE, NCV7800



Figure 7. Output Impedance as a Function of Output Voltage (MC78XXC, AC, B)

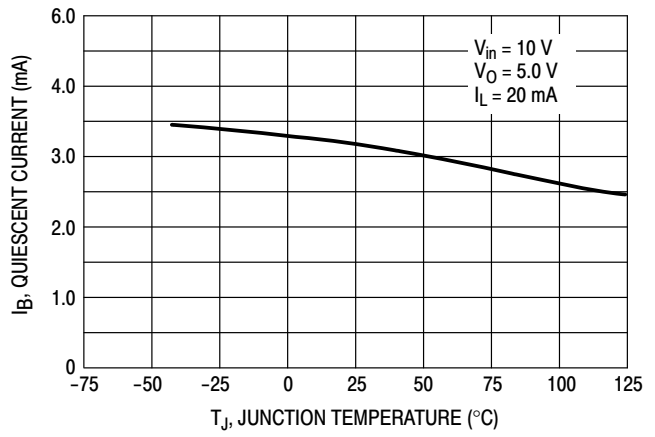

Figure 8. Quiescent Current as a Function of Temperature (MC78XXC, AC, B)

APPLICATIONS INFORMATION

Design Considerations

The MC7800 Series of fixed voltage regulators are designed with Thermal Overload Protection that shuts down the circuit when subjected to an excessive power overload condition, Internal Short Circuit Protection that limits the maximum current the circuit will pass, and Output Transistor Safe-Area Compensation that reduces the output short circuit current as the voltage across the pass transistor is increased.

In many low current applications, compensation capacitors are not required. However, it is recommended that the regulator input be bypassed with a capacitor if the regulator is connected to the power supply filter with long

wire lengths, or if the output load capacitance is large. An input bypass capacitor should be selected to provide good high-frequency characteristics to insure stable operation under all load conditions. A 0.33 μF or larger tantalum, mylar, or other capacitor having low internal impedance at high frequencies should be chosen. The bypass capacitor should be mounted with the shortest possible leads directly across the regulators input terminals. Normally good construction techniques should be used to minimize ground loops and lead resistance drops since the regulator has no external sense lead.

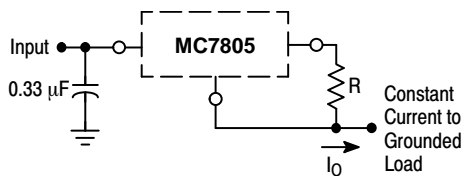

The MC7800 regulators can also be used as a current source when connected as above. In order to minimize dissipation the MC7805C is chosen in this application. Resistor R determines the current as follows:

$$I_O = \frac{5.0 \text{ V}}{R} + I_B$$

$I_B \cong 3.2 \text{ mA}$  over line and load changes.

For example, a 1.0 A current source would require R to be a 5.0 Ω, 10 W resistor and the output voltage compliance would be the input voltage less 7.0 V.

Figure 9. Current Regulator

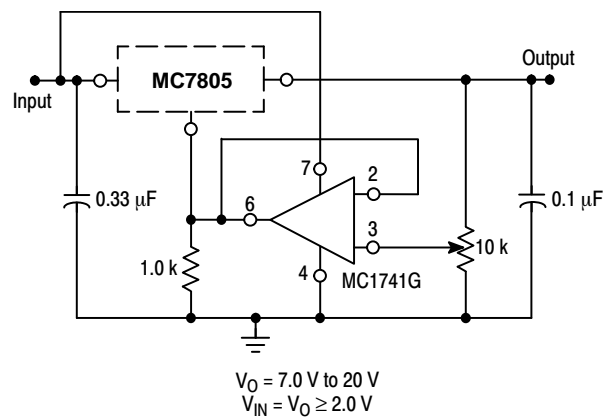

$V_O = 7.0 \text{ V to } 20 \text{ V}$   
 $V_{IN} = V_O \geq 2.0 \text{ V}$

The addition of an operational amplifier allows adjustment to higher or intermediate values while retaining regulation characteristics. The minimum voltage obtainable with this arrangement is 2.0 V greater than the regulator voltage.

Figure 10. Adjustable Output Regulator

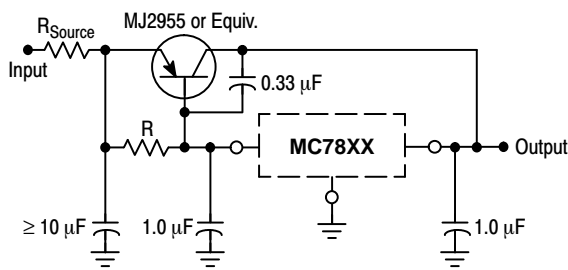

XX = 2 digits of type number indicating voltage.

The MC7800 series can be current boosted with a PNP transistor. The MJ2955 provides current to 5.0 A. Resistor R in conjunction with the  $V_{BE}$  of the PNP determines when the pass transistor begins conducting; this circuit is not short circuit proof. Input/output differential voltage minimum is increased by  $V_{BE}$  of the pass transistor.

Figure 11. Current Boost Regulator

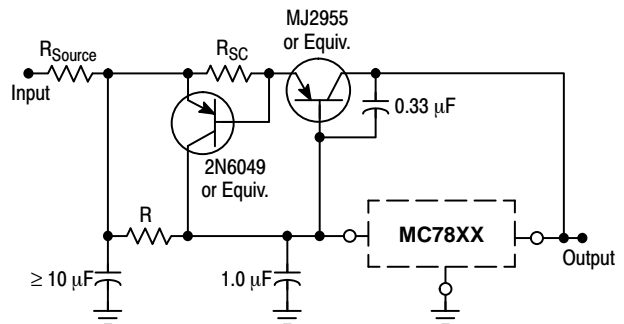

XX = 2 digits of type number indicating voltage.

The circuit of Figure 11 can be modified to provide supply protection against short circuits by adding a short circuit sense resistor,  $R_{SC}$ , and an additional PNP transistor. The current sensing PNP must be able to handle the short circuit current of the three-terminal regulator. Therefore, a four-ampere plastic power transistor is specified.

Figure 12. Short Circuit Protection

# MC7800, MC7800A, MC7800AE, NCV7800

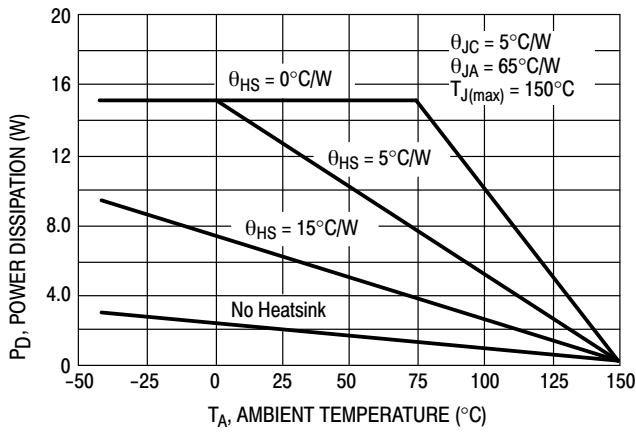

Figure 13. Worst Case Power Dissipation versus Ambient Temperature (Case 221A)

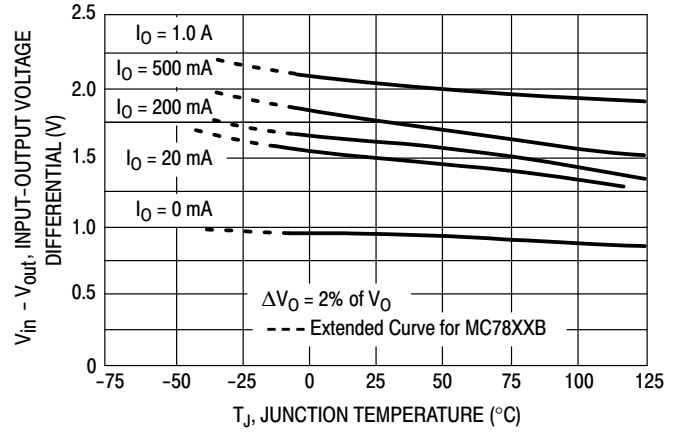

Figure 14. Input Output Differential as a Function of Junction Temperature (MC78XXC, AC, B)

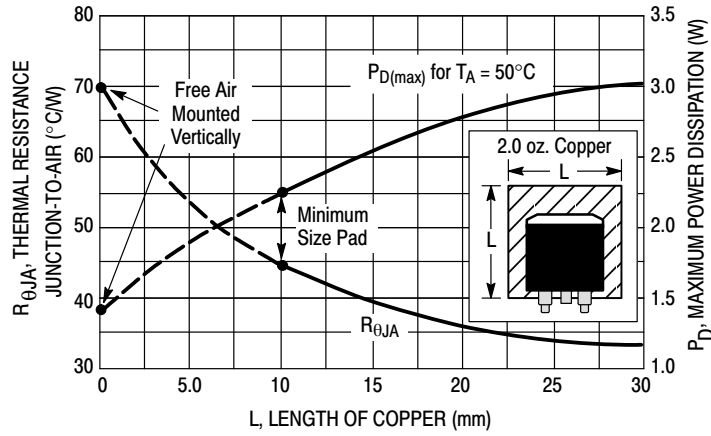

Figure 15. D<sup>2</sup>PAK Thermal Resistance and Maximum Power Dissipation versus P.C.B. Copper Length

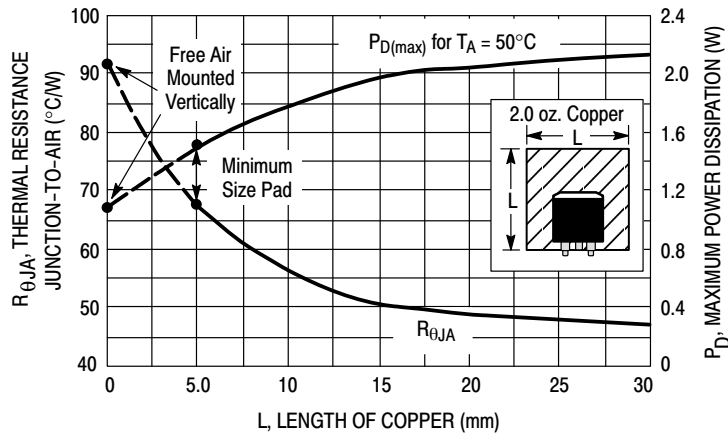

Figure 16. DPAK Thermal Resistance and Maximum Power Dissipation versus P.C.B. Copper Length

# MC7800, MC7800A, MC7800AE, NCV7800

## DEFINITIONS

**Line Regulation** – The change in output voltage for a change in the input voltage. The measurement is made under conditions of low dissipation or by using pulse techniques such that the average chip temperature is not significantly affected.

**Load Regulation** – The change in output voltage for a change in load current at constant chip temperature.

**Maximum Power Dissipation** – The maximum total device dissipation for which the regulator will operate within specifications.

**Quiescent Current** – That part of the input current that is not delivered to the load.

**Output Noise Voltage** – The rms ac voltage at the output, with constant load and no input ripple, measured over a specified frequency range.

**Long Term Stability** – Output voltage stability under accelerated life test conditions with the maximum rated voltage listed in the devices' electrical characteristics and maximum power dissipation.

## ORDERING INFORMATION

Device	Nominal Voltage	Operating Temperature Range	Package	Shipping <sup>†</sup>
MC7805ABD2TG	5.0 V	T <sub>J</sub> = -40°C to +125°C	D <sup>2</sup> PAK (Pb-free)	50 Units /Rail
MC7805ABD2TR4G	5.0 V	T <sub>J</sub> = -40°C to +125°C	D <sup>2</sup> PAK (Pb-free)	800 / Tape & Reel
NCV7805ABD2TR4G*	5.0 V	T <sub>J</sub> = -40°C to +125°C	D <sup>2</sup> PAK (Pb-free)	800 / Tape & Reel
MC7805ABTG	5.0 V	T <sub>J</sub> = -40°C to +125°C	TO-220 (Pb-free)	50 Units /Rail
MC7805ACD2TG	5.0 V	T <sub>J</sub> = 0°C to +125°C	D <sup>2</sup> PAK (Pb-free)	50 Units /Rail
MC7805ACD2TR4G	5.0 V	T <sub>J</sub> = 0°C to +125°C	D <sup>2</sup> PAK (Pb-free)	800 / Tape & Reel
MC7805ACTG	5.0 V	T <sub>J</sub> = 0°C to +125°C	TO-220 (Pb-free)	50 Units /Rail
MC7805BD2TG	5.0 V	T <sub>J</sub> = -40°C to +125°C	D <sup>2</sup> PAK (Pb-free)	50 Units /Rail
MC7805BD2TR4G	5.0 V	T <sub>J</sub> = -40°C to +125°C	D <sup>2</sup> PAK (Pb-free)	800 / Tape & Reel
MC7805BDTG	5.0 V	T <sub>J</sub> = -40°C to +125°C	DPAK (Pb-free)	75 Units / Rail
MC7805BDTRKG	5.0 V	T <sub>J</sub> = -40°C to +125°C	DPAK (Pb-free)	2500 / Tape & Reel
NCV7805BDTRKG*	5.0 V	T <sub>J</sub> = -40°C to +125°C	DPAK (Pb-free)	2500 / Tape & Reel
MC7805BTG	5.0 V	T <sub>J</sub> = -40°C to +125°C	TO-220 (Pb-free)	50 Units /Rail
NCV7805BTG*	5.0 V	T <sub>J</sub> = -40°C to +125°C	TO-220 (Pb-free)	50 Units /Rail
NCV7805BD2TG*	5.0 V	T <sub>J</sub> = -40°C to +125°C	D <sup>2</sup> PAK (Pb-free)	50 Units /Rail
NCV7805BD2TR4G*	5.0 V	T <sub>J</sub> = -40°C to +125°C	D <sup>2</sup> PAK (Pb-free)	800 / Tape & Reel
MC7805CD2TG	5.0 V	T <sub>J</sub> = 0°C to +125°C	D <sup>2</sup> PAK (Pb-free)	50 Units /Rail

<sup>†</sup>For information on tape and reel specifications, including part orientation and tape sizes, please refer to our Tape and Reel Packaging Specifications Brochure, BRD8011/D.

\*NCV devices: T<sub>low</sub> = -40°C, T<sub>high</sub> = +125°C. Guaranteed by design. NCV Prefix for Automotive and Other Applications Requiring Unique Site and Control Change Requirements; AEC-Q100 Qualified and PPAP Capable.

## MC7800, MC7800A, MC7800AE, NCV7800

### ORDERING INFORMATION (continued)

Device	Nominal Voltage	Operating Temperature Range	Package	Shipping <sup>†</sup>
MC7805CD2TR4G	5.0 V	T <sub>J</sub> = 0°C to +125°C	D <sup>2</sup> PAK (Pb-free)	800 / Tape & Reel
MC7805CDTG	5.0 V	T <sub>J</sub> = 0°C to +125°C	DPAK (Pb-free)	75 Units / Rail
MC7805CDTRKG	5.0 V	T <sub>J</sub> = 0°C to +125°C	DPAK (Pb-free)	2500 / Tape & Reel
MC7805CTG	5.0 V	T <sub>J</sub> = 0°C to +125°C	TO-220 (Pb-free)	50 Units /Rail
MC7806ACTG	6.0 V	T <sub>J</sub> = 0°C to +125°C	TO-220 (Pb-free)	50 Units /Rail
MC7806BD2TG	6.0 V	T <sub>J</sub> = -40°C to +125°C	D <sup>2</sup> PAK (Pb-free)	50 Units /Rail
MC7806BD2TR4G	6.0 V	T <sub>J</sub> = -40°C to +125°C	D <sup>2</sup> PAK (Pb-free)	800 / Tape & Reel
MC7806BTG	6.0 V	T <sub>J</sub> = -40°C to +125°C	TO-220 (Pb-free)	50 Units /Rail
MC7806CTG	6.0 V	T <sub>J</sub> = 0°C to +125°C	TO-220 (Pb-free)	50 Units /Rail
MC7808ABD2TG	8.0 V	T <sub>J</sub> = -40°C to +125°C	D <sup>2</sup> PAK (Pb-free)	50 Units / Rail
MC7808ABD2TR4G	8.0 V	T <sub>J</sub> = -40°C to +125°C	D <sup>2</sup> PAK (Pb-free)	800 / Tape & Reel
NCV7808ABD2TR4G*	8.0 V	T <sub>J</sub> = -40°C to +125°C	D <sup>2</sup> PAK (Pb-free)	800 / Tape & Reel
MC7808ABTG	8.0 V	T <sub>J</sub> = -40°C to +125°C	TO-220 (Pb-free)	50 Units / Rail
MC7808ACTG	8.0 V	T <sub>J</sub> = 0°C to +125°C	TO-220 (Pb-free)	50 Units / Rail
MC7808AEBTG	8.0 V	T <sub>J</sub> = -40°C to +125°C	TO-220 (Pb-free)	50 Units / Rail
MC7808BD2TG	8.0 V	T <sub>J</sub> = -40°C to +125°C	D <sup>2</sup> PAK (Pb-free)	50 Units / Rail
MC7808BD2TR4G	8.0 V	T <sub>J</sub> = -40°C to +125°C	D <sup>2</sup> PAK (Pb-free)	800 / Tape & Reel
NCV7808BD2TR4G*	8.0 V	T <sub>J</sub> = -40°C to +125°C	D <sup>2</sup> PAK (Pb-free)	800 / Tape & Reel
MC7808BDTG	8.0 V	T <sub>J</sub> = -40°C to +125°C	DPAK (Pb-free)	75 Units / Rail
NCV7808BDTG*	8.0 V	T <sub>J</sub> = -40°C to +125°C	DPAK (Pb-free)	75 Units / Rail
MC7808BDTRKG	8.0 V	T <sub>J</sub> = -40°C to +125°C	DPAK (Pb-free)	2500 / Tape & Reel
NCV7808BDTRKG*	8.0 V	T <sub>J</sub> = -40°C to +125°C	DPAK (Pb-free)	2500 / Tape & Reel
MC7808BTG	8.0 V	T <sub>J</sub> = -40°C to +125°C	TO-220 (Pb-free)	50 Units /Rail

<sup>†</sup>For information on tape and reel specifications, including part orientation and tape sizes, please refer to our Tape and Reel Packaging Specifications Brochure, BRD8011/D.

\*NCV devices: T<sub>low</sub> = -40°C, T<sub>high</sub> = +125°C. Guaranteed by design. NCV Prefix for Automotive and Other Applications Requiring Unique Site and Control Change Requirements; AEC-Q100 Qualified and PPAP Capable.



## MC7800, MC7800A, MC7800AE, NCV7800

### ORDERING INFORMATION (continued)

Device	Nominal Voltage	Operating Temperature Range	Package	Shipping <sup>†</sup>
NCV7808BTG*	8.0 V	T <sub>J</sub> = -40°C to +125°C	TO-220 (Pb-free)	50 Units / Rail
MC7808CD2TG	8.0 V	T <sub>J</sub> = 0°C to +125°C	D <sup>2</sup> PAK (Pb-free)	50 Units / Rail
MC7808CD2TR4G	8.0 V	T <sub>J</sub> = 0°C to +125°C	D <sup>2</sup> PAK (Pb-free)	800 / Tape & Reel
MC7808CDTG	8.0 V	T <sub>J</sub> = 0°C to +125°C	DPAK (Pb-free)	75 Units / Rail
MC7808CDTT5G	8.0 V	T <sub>J</sub> = 0°C to +125°C	DPAK (Pb-free)	2500 / Tape & Reel
MC7808CDTRKG	8.0 V	T <sub>J</sub> = 0°C to +125°C	DPAK (Pb-free)	2500 / Tape & Reel
MC7808CTG	8.0 V	T <sub>J</sub> = 0°C to +125°C	TO-220 (Pb-free)	50 Units / Rail
MC7809ABTG	9.0 V	T <sub>J</sub> = -40°C to +125°C	TO-220 (Pb-free)	50 Units / Rail
MC7809ACTG	9.0 V	T <sub>J</sub> = 0°C to +125°C	TO-220 (Pb-free)	50 Units / Rail
NCV7809BD2TR4G*	9.0 V	T <sub>J</sub> = -40°C to +125°C	D <sup>2</sup> PAK (Pb-free)	800 / Tape & Reel
MC7809BTG	9.0 V	T <sub>J</sub> = -40°C to +125°C	TO-220 (Pb-free)	50 Units / Rail
NCV7809BTG*	9.0 V	T <sub>J</sub> = -40°C to +125°C	TO-220 (Pb-free)	50 Units / Rail
MC7809CD2TG	9.0 V	T <sub>J</sub> = 0°C to +125°C	D <sup>2</sup> PAK (Pb-free)	50 Units / Rail
MC7809CD2TR4G	9.0 V	T <sub>J</sub> = 0°C to +125°C	D <sup>2</sup> PAK (Pb-free)	800 / Tape & Reel
MC7809CTG	9.0 V	T <sub>J</sub> = 0°C to +125°C	TO-220 (Pb-free)	50 Units / Rail
MC7812ABD2TG	12 V	T <sub>J</sub> = -40°C to +125°C	D <sup>2</sup> PAK (Pb-free)	50 Units / Rail
MC7812ABD2TR4G	12 V	T <sub>J</sub> = -40°C to +125°C	D <sup>2</sup> PAK (Pb-free)	800 / Tape & Reel
MC7812ABTG	12 V	T <sub>J</sub> = -40°C to +125°C	TO-220 (Pb-free)	50 Units / Rail
NCV7812ABTG*	12 V	T <sub>J</sub> = -40°C to +125°C	TO-220 (Pb-free)	50 Units / Rail
MC7812ACD2TG	12 V	T <sub>J</sub> = 0°C to +125°C	D <sup>2</sup> PAK (Pb-free)	50 Units / Rail
MC7812ACD2TR4G	12 V	T <sub>J</sub> = 0°C to +125°C	D <sup>2</sup> PAK (Pb-free)	800 / Tape & Reel
MC7812ACTG	12 V	T <sub>J</sub> = 0°C to +125°C	TO-220 (Pb-free)	50 Units / Rail
MC7812BD2TG	12 V	T <sub>J</sub> = -40°C to +125°C	D <sup>2</sup> PAK (Pb-free)	50 Units / Rail

<sup>†</sup>For information on tape and reel specifications, including part orientation and tape sizes, please refer to our Tape and Reel Packaging Specifications Brochure, BRD8011/D.

\*NCV devices: T<sub>low</sub> = -40°C, T<sub>high</sub> = +125°C. Guaranteed by design. NCV Prefix for Automotive and Other Applications Requiring Unique Site and Control Change Requirements; AEC-Q100 Qualified and PPAP Capable.

## MC7800, MC7800A, MC7800AE, NCV7800

### ORDERING INFORMATION (continued)

Device	Nominal Voltage	Operating Temperature Range	Package	Shipping <sup>†</sup>
MC7812BD2TR4G	12 V	T <sub>J</sub> = -40°C to +125°C	D <sup>2</sup> PAK (Pb-free)	800 / Tape & Reel
NCV7812BD2TR4G*	12 V	T <sub>J</sub> = -40°C to +125°C	D <sup>2</sup> PAK (Pb-free)	800 / Tape & Reel
MC7812BDTG	12 V	T <sub>J</sub> = -40°C to +125°C	DPAK (Pb-free)	75 Units / Rail
MC7812BDTRKG	12 V	T <sub>J</sub> = -40°C to +125°C	DPAK (Pb-free)	2500 / Tape & Reel
MC7812BTG	12 V	T <sub>J</sub> = -40°C to +125°C	TO-220 (Pb-free)	50 Units / Rail
NCV7812BTG*	12 V	T <sub>J</sub> = -40°C to +125°C	TO-220 (Pb-free)	50 Units /Rail
MC7812CD2TG	12 V	T <sub>J</sub> = 0°C to +125°C	D <sup>2</sup> PAK (Pb-free)	50 Units /Rail
MC7812CD2TR4G	12 V	T <sub>J</sub> = 0°C to +125°C	D <sup>2</sup> PAK (Pb-free)	800 / Tape & Reel
MC7812CDTG	12 V	T <sub>J</sub> = 0°C to +125°C	DPAK (Pb-free)	75 Units / Rail
MC7812CDTRKG	12 V	T <sub>J</sub> = 0°C to +125°C	DPAK (Pb-free)	2500 / Tape & Reel
MC7812CTG	12 V	T <sub>J</sub> = 0°C to +125°C	TO-220 (Pb-free)	50 Units / Rail
MC7815ABD2TG	15 V	T <sub>J</sub> = -40°C to +125°C	D <sup>2</sup> PAK (Pb-free)	50 Units /Rail
MC7815ABD2TR4G	15 V	T <sub>J</sub> = -40°C to +125°C	D <sup>2</sup> PAK (Pb-free)	800 / Tape & Reel
MC7815ABTG	15 V	T <sub>J</sub> = -40°C to +125°C	TO-220 (Pb-free)	50 Units /Rail
MC7815ACD2TG	15 V	T <sub>J</sub> = 0°C to +125°C	D <sup>2</sup> PAK (Pb-free)	50 Units /Rail
MC7815ACTG	15 V	T <sub>J</sub> = 0°C to +125°C	TO-220 (Pb-free)	50 Units / Rail
MC7815BD2TG	15 V	T <sub>J</sub> = -40°C to +125°C	D <sup>2</sup> PAK (Pb-free)	50 Units /Rail
MC7815BD2TR4G	15 V	T <sub>J</sub> = -40°C to +125°C	D <sup>2</sup> PAK (Pb-free)	800 / Tape & Reel
MC7815BDTG	15 V	T <sub>J</sub> = -40°C to +125°C	DPAK (Pb-free)	75 Units / Rail
MC7815BDTRKG	15 V	T <sub>J</sub> = -40°C to +125°C	DPAK (Pb-free)	2500 / Tape & Reel
MC7815BTG	15 V	T <sub>J</sub> = -40°C to +125°C	TO-220 (Pb-free)	50 Units / Rail
NCV7815BTG*	15 V	T <sub>J</sub> = -40°C to +125°C	TO-220 (Pb-free)	50 Units / Rail
MC7815CD2TG	15 V	T <sub>J</sub> = 0°C to +125°C	D <sup>2</sup> PAK (Pb-free)	50 Units /Rail

<sup>†</sup>For information on tape and reel specifications, including part orientation and tape sizes, please refer to our Tape and Reel Packaging Specifications Brochure, BRD8011/D.

\*NCV devices: T<sub>low</sub> = -40°C, T<sub>high</sub> = +125°C. Guaranteed by design. NCV Prefix for Automotive and Other Applications Requiring Unique Site and Control Change Requirements; AEC-Q100 Qualified and PPAP Capable.

## MC7800, MC7800A, MC7800AE, NCV7800

### ORDERING INFORMATION (continued)

Device	Nominal Voltage	Operating Temperature Range	Package	Shipping <sup>†</sup>
MC7815CD2TR4G	15 V	T <sub>J</sub> = 0°C to +125°C	D <sup>2</sup> PAK (Pb-free)	800 / Tape & Reel
MC7815CDTG	15 V	T <sub>J</sub> = 0°C to +125°C	DPAK (Pb-free)	75 Units / Rail
MC7815CDTRKG	15 V	T <sub>J</sub> = 0°C to +125°C	DPAK (Pb-free)	2500 / Tape & Reel
MC7815CTG	15 V	T <sub>J</sub> = 0°C to +125°C	TO-220 (Pb-free)	50 Units /Rail
MC7818ACTG	18 V	T <sub>J</sub> = 0°C to +125°C	TO-220 (Pb-free)	50 Units /Rail
MC7818BTG	18 V	T <sub>J</sub> = -40°C to +125°C	TO-220 (Pb-free)	50 Units /Rail
MC7818CD2TR4G	18 V	T <sub>J</sub> = 0°C to +125°C	D <sup>2</sup> PAK (Pb-free)	800 / Tape & Reel
MC7818CTG	18 V	T <sub>J</sub> = 0°C to +125°C	TO-220 (Pb-free)	50 Units /Rail
MC7824ACTG	24 V	T <sub>J</sub> = 0°C to +125°C	TO-220 (Pb-free)	50 Units /Rail
MC7824BD2TG	24 V	T <sub>J</sub> = -40°C to +125°C	D <sup>2</sup> PAK (Pb-free)	50 Units /Rail
MC7824BD2TR4G	24 V	T <sub>J</sub> = -40°C to +125°C	D <sup>2</sup> PAK (Pb-free)	800 / Tape & Reel
MC7824BTG	24 V	T <sub>J</sub> = -40°C to +125°C	TO-220 (Pb-free)	50 Units /Rail
MC7824CD2TG	24 V	T <sub>J</sub> = 0°C to +125°C	D <sup>2</sup> PAK (Pb-free)	50 Units /Rail
MC7824CD2TR4G	24 V	T <sub>J</sub> = 0°C to +125°C	D <sup>2</sup> PAK (Pb-free)	800 / Tape & Reel
MC7824CTG	24 V	T <sub>J</sub> = 0°C to +125°C	TO-220 (Pb-free)	50 Units /Rail

†For information on tape and reel specifications, including part orientation and tape sizes, please refer to our Tape and Reel Packaging Specifications Brochure, BRD8011/D.

\*NCV devices: T<sub>low</sub> = -40°C, T<sub>high</sub> = +125°C. Guaranteed by design. NCV Prefix for Automotive and Other Applications Requiring Unique Site and Control Change Requirements; AEC-Q100 Qualified and PPAP Capable.

# MC7800, MC7800A, MC7800AE, NCV7800

## MARKING DIAGRAMS

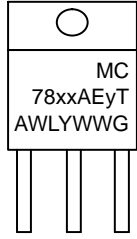

**TO-220-3  
T SUFFIX  
CASE 221A**

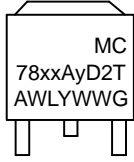
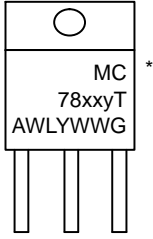
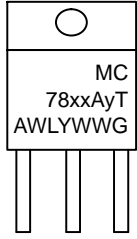

**D<sup>2</sup>PAK-3  
D2T SUFFIX  
CASE 936**

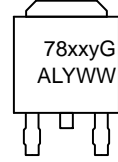
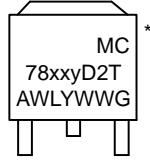

**DPAK-3  
DT SUFFIX  
CASE 369C**

\*This marking diagram also applies to NCV78xx family.

xx = 05, 06, 08, 09, 12, 15, 18, or 24  
y = B or C  
A = Assembly Location  
WL, L = Wafer Lot  
Y = Year  
WW = Work Week  
G = Pb-Free Device

# MC7800, MC7800A, MC7800AE, NCV7800

## PACKAGE DIMENSIONS

### TO-220, SINGLE GAUGE CASE 221AB ISSUE A

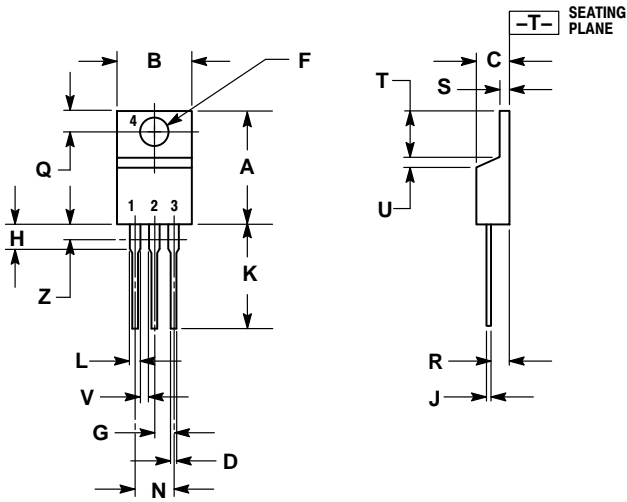

- NOTES:
1. DIMENSIONING AND TOLERANCING PER ANSI Y14.5M, 1982.
  2. CONTROLLING DIMENSION: INCHES.
  3. DIMENSION Z DEFINES A ZONE WHERE ALL BODY AND LEAD IRREGULARITIES ARE ALLOWED.
  4. PRODUCT SHIPPED PRIOR TO 2008 HAD DIMENSIONS  
S = 0.045 - 0.055 INCHES (1.143 - 1.397 MM)

DIM	INCHES		MILLIMETERS	
	MIN	MAX	MIN	MAX
A	0.570	0.620	14.48	15.75
B	0.380	0.405	9.66	10.28
C	0.160	0.190	4.07	4.82
D	0.025	0.035	0.64	0.88
F	0.142	0.147	3.61	3.73
G	0.095	0.105	2.42	2.66
H	0.110	0.155	2.80	3.93
J	0.018	0.025	0.46	0.64
K	0.500	0.562	12.70	14.27
L	0.045	0.060	1.15	1.52
N	0.190	0.210	4.83	5.33
Q	0.100	0.120	2.54	3.04
R	0.080	0.110	2.04	2.79
S	0.020	0.024	0.508	0.61
T	0.235	0.255	5.97	6.47
U	0.000	0.050	0.00	1.27
V	0.045	---	1.15	---
Z	---	0.080	---	2.04

# MC7800, MC7800A, MC7800AE, NCV7800

## PACKAGE DIMENSIONS

### D<sup>2</sup>PAK-3 CASE 936-03 ISSUE D

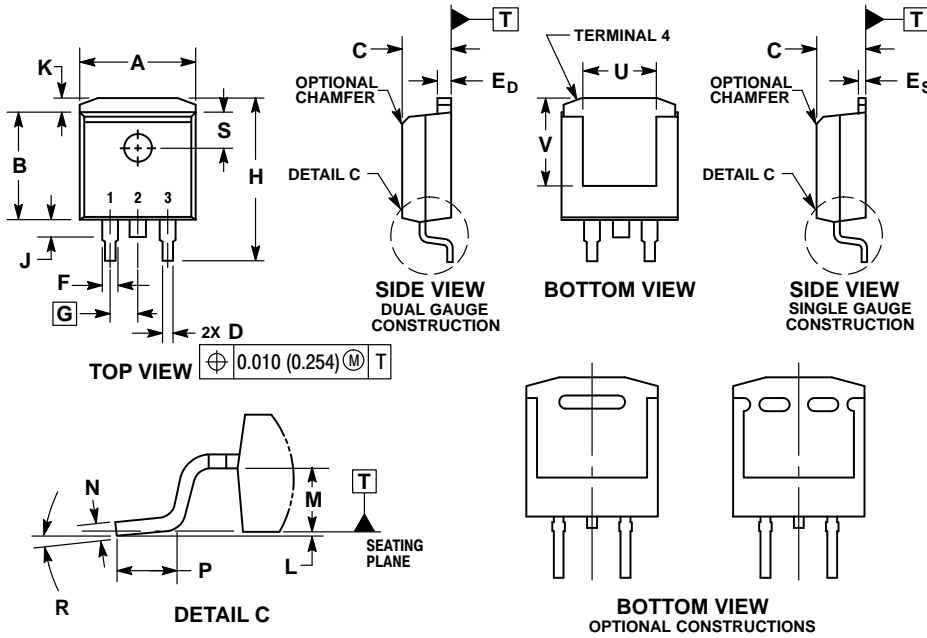

**NOTES:**

1. DIMENSIONING AND TOLERANCING PER ANSI Y14.5M, 1982.
2. CONTROLLING DIMENSION: INCHES.
3. TAB CONTOUR OPTIONAL WITHIN DIMENSIONS A AND K.
4. DIMENSIONS U AND V ESTABLISH A MINIMUM MOUNTING SURFACE FOR TERMINAL 4.
5. DIMENSIONS A AND B DO NOT INCLUDE MOLD FLASH OR GATE PROTRUSIONS. MOLD FLASH AND GATE PROTRUSIONS NOT TO EXCEED 0.025 (0.635) MAXIMUM.
6. SINGLE GAUGE DESIGN WILL BE SHIPPED AFTER FPCN EXPIRATION IN OCTOBER 2011.

DIM	INCHES		MILLIMETERS	
	MIN	MAX	MIN	MAX
A	0.386	0.403	9.804	10.236
B	0.356	0.368	9.042	9.347
C	0.170	0.180	4.318	4.572
D	0.026	0.036	0.660	0.914
E <sub>D</sub>	0.045	0.055	1.143	1.397
E <sub>S</sub>	0.018	0.026	0.457	0.660
F	0.051 REF		1.295 REF	
G	0.100 BSC		2.540 BSC	
H	0.539	0.579	13.691	14.707
J	0.125 MAX		3.175 MAX	
K	0.050 REF		1.270 REF	
L	0.000	0.010	0.000	0.254
M	0.088	0.102	2.235	2.591
N	0.018	0.026	0.457	0.660
P	0.058	0.078	1.473	1.981
R	5° REF		5° REF	
S	0.116 REF		2.946 REF	
U	0.200 MIN		5.080 MIN	
V	0.250 MIN		6.350 MIN	

### SOLDERING FOOTPRINT\*

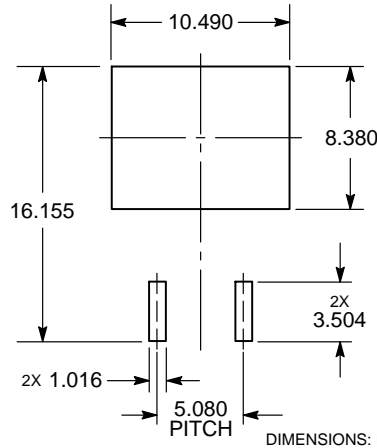

\*For additional information on our Pb-Free strategy and soldering details, please download the ON Semiconductor Soldering and Mounting Techniques Reference Manual, SOLDERRM/D.

# MC7800, MC7800A, MC7800AE, NCV7800

## PACKAGE DIMENSIONS

### DPAK-3 CASE 369C ISSUE D

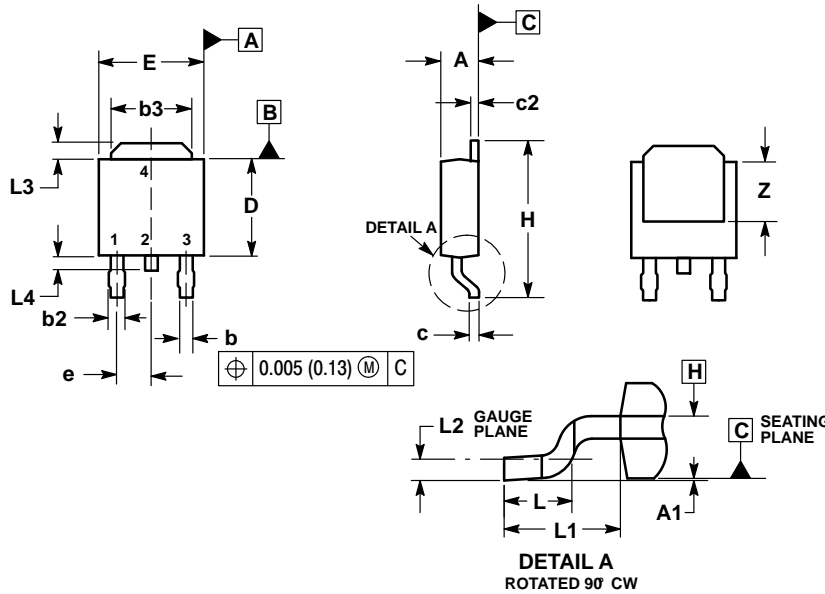

**NOTES:**

1. DIMENSIONING AND TOLERANCING PER ASME Y14.5M, 1994.
2. CONTROLLING DIMENSION: INCHES.
3. THERMAL PAD CONTOUR OPTIONAL WITHIN DIMENSIONS b3, L3 and Z.
4. DIMENSIONS D AND E DO NOT INCLUDE MOLD FLASH, PROTRUSIONS, OR BURRS. MOLD FLASH, PROTRUSIONS, OR GATE BURRS SHALL NOT EXCEED 0.006 INCHES PER SIDE.
5. DIMENSIONS D AND E ARE DETERMINED AT THE OUTERMOST EXTREMES OF THE PLASTIC BODY.
6. DATUMS A AND B ARE DETERMINED AT DATUM PLANE H.

DIM	INCHES		MILLIMETERS	
	MIN	MAX	MIN	MAX
A	0.086	0.094	2.18	2.38
A1	0.000	0.005	0.00	0.13
b	0.025	0.035	0.63	0.89
b2	0.030	0.045	0.76	1.14
b3	0.180	0.215	4.57	5.46
c	0.018	0.024	0.46	0.61
c2	0.018	0.024	0.46	0.61
D	0.235	0.245	5.97	6.22
E	0.250	0.265	6.35	6.73
e	0.090 BSC		2.29 BSC	
H	0.370	0.410	9.40	10.41
L	0.055	0.070	1.40	1.78
L1	0.108 REF		2.74 REF	
L2	0.020 BSC		0.51 BSC	
L3	0.035	0.050	0.89	1.27
L4	---	0.040	---	1.01
Z	0.155	---	3.93	---

### SOLDERING FOOTPRINT\*

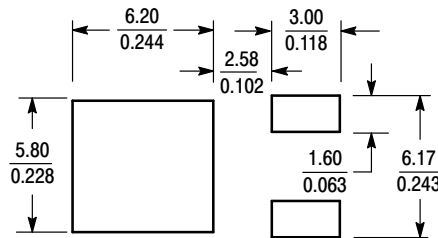

SCALE 3:1 (mm/inches)

\*For additional information on our Pb-Free strategy and soldering details, please download the ON Semiconductor Soldering and Mounting Techniques Reference Manual, SOLDERRM/D.

ON Semiconductor and are registered trademarks of Semiconductor Components Industries, LLC (SCILLC). SCILLC owns the rights to a number of patents, trademarks, copyrights, trade secrets, and other intellectual property. A listing of SCILLC's product/patent coverage may be accessed at [www.onsemi.com/site/pdf/Patent-Marking.pdf](http://www.onsemi.com/site/pdf/Patent-Marking.pdf). SCILLC reserves the right to make changes without further notice to any products herein. SCILLC makes no warranty, representation or guarantee regarding the suitability of its products for any particular purpose, nor does SCILLC assume any liability arising out of the application or use of any product or circuit, and specifically disclaims any and all liability, including without limitation special, consequential or incidental damages. "Typical" parameters which may be provided in SCILLC data sheets and/or specifications can and do vary in different applications and actual performance may vary over time. All operating parameters, including "Typicals" must be validated for each customer application by customer's technical experts. SCILLC does not convey any license under its patent rights nor the rights of others. SCILLC products are not designed, intended, or authorized for use as components in systems intended for surgical implant into the body, or other applications intended to support or sustain life, or for any other application in which the failure of the SCILLC product could create a situation where personal injury or death may occur. Should Buyer purchase or use SCILLC products for any such unintended or unauthorized application, Buyer shall indemnify and hold SCILLC and its officers, employees, subsidiaries, affiliates, and distributors harmless against all claims, costs, damages, and expenses, and reasonable attorney fees arising out of, directly or indirectly, any claim of personal injury or death associated with such unintended or unauthorized use, even if such claim alleges that SCILLC was negligent regarding the design or manufacture of the part. SCILLC is an Equal Opportunity/Affirmative Action Employer. This literature is subject to all applicable copyright laws and is not for resale in any manner.

### PUBLICATION ORDERING INFORMATION

**LITERATURE FULFILLMENT:**  
Literature Distribution Center for ON Semiconductor  
P.O. Box 5163, Denver, Colorado 80217 USA  
**Phone:** 303-675-2175 or 800-344-3860 Toll Free USA/Canada  
**Fax:** 303-675-2176 or 800-344-3867 Toll Free USA/Canada  
**Email:** [orderlit@onsemi.com](mailto:orderlit@onsemi.com)

**N. American Technical Support:** 800-282-9855 Toll Free  
USA/Canada  
**Europe, Middle East and Africa Technical Support:**  
Phone: 421 33 790 2910  
**Japan Customer Focus Center**  
Phone: 81-3-5817-1050

**ON Semiconductor Website:** [www.onsemi.com](http://www.onsemi.com)  
**Order Literature:** <http://www.onsemi.com/orderlit>

For additional information, please contact your local Sales Representative