

## Single and Dual Precision, 17 MHz, Low Noise, CMOS Input Amplifiers

Check for Samples: [LMP7715](#), [LMP7716](#), [LMP7716Q](#)

### FEATURES

- Unless Otherwise Noted, Typical Values at  $V_S = 5V$ .
  - Input Offset Voltage  $\pm 150 \mu V$  (Max)
  - Input Bias Current 100 fA
  - Input Voltage Noise  $5.8 \text{ nV}/\sqrt{\text{Hz}}$
  - Gain Bandwidth Product 17 MHz
  - Supply Current (LMP7715) 1.15 mA
  - Supply Current (LMP7716/LMP7716Q) 1.30 mA
  - Supply Voltage Range 1.8V to 5.5V
  - THD+N @  $f = 1 \text{ kHz}$  0.001%
  - Operating Temperature Range  $-40^\circ\text{C}$  to  $125^\circ\text{C}$
  - Rail-to-rail Output Swing
  - Space Saving SOT-23 Package (LMP7715)
  - 8-Pin VSSOP Package (LMP7716/LMP7716Q)
  - LMP7716Q is AEC-Q100 Grade 1 Qualified and is Manufactured on an Automotive Grade Flow

### APPLICATIONS

- Active Filters and Buffers
- Sensor Interface Applications
- Transimpedance Amplifiers
- Automotive

### DESCRIPTION

The LMP7715/LMP7716/LMP7716Q are single and dual low noise, low offset, CMOS input, rail-to-rail output precision amplifiers with high gain bandwidth products. The LMP7715/LMP7716/LMP7716Q are part of the LMP™ precision amplifier family and are ideal for a variety of instrumentation applications.

Utilizing a CMOS input stage, the LMP7715/LMP7716/LMP7716Q achieve an input bias current of 100 fA, an input referred voltage noise of  $5.8 \text{ nV}/\sqrt{\text{Hz}}$ , and an input offset voltage of less than  $\pm 150 \mu V$ . These features make the LMP7715/LMP7716/LMP7716Q superior choices for precision applications.

Consuming only 1.15 mA of supply current, the LMP7715 offers a high gain bandwidth product of 17 MHz, enabling accurate amplification at high closed loop gains.

The LMP7715/LMP7716/LMP7716Q have a supply voltage range of 1.8V to 5.5V, which makes these ideal choices for portable low power applications with low supply voltage requirements.

The LMP7715/LMP7716/LMP7716Q are built with TI's advanced VIP50 process technology. The LMP7715 is offered in a 5-pin SOT-23 package and the LMP7716/LMP7716Q is offered in an 8-pin VSSOP.

The LMP7716Q incorporates enhanced manufacturing and support processes for the automotive market, including defect detection methodologies. Reliability qualification is compliant with the requirements and temperature grades defined in the AEC-Q100 standard.



Please be aware that an important notice concerning availability, standard warranty, and use in critical applications of Texas Instruments semiconductor products and disclaimers thereto appears at the end of this data sheet.

LMP is a trademark of Texas Instruments.

All other trademarks are the property of their respective owners.

### Typical Performance

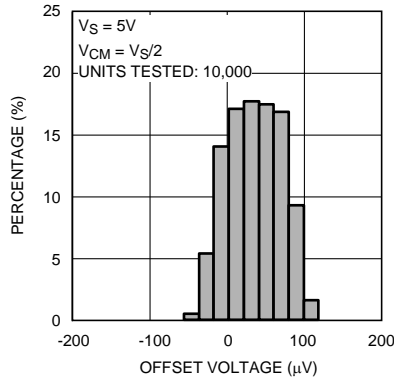

Figure 1. Offset Voltage Distribution

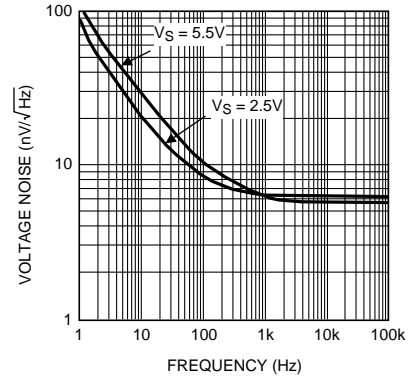

Figure 2. Input Referred Voltage Noise



These devices have limited built-in ESD protection. The leads should be shorted together or the device placed in conductive foam during storage or handling to prevent electrostatic damage to the MOS gates.

### Absolute Maximum Ratings<sup>(1)(2)</sup>

|  |                                    |  |
|--|------------------------------------|--|
| ESD Tolerance <sup>(3)</sup>                                       | Human Body Model                   | 2000V                                      |
|  | Machine Model                      | 200V                                       |
|  | Charge-Device Model                | 1000V                                      |
| V <sub>IN</sub> Differential                                       |                                    | ±0.3V                                      |
| Supply Voltage (V <sub>S</sub> = V <sup>+</sup> – V <sup>-</sup> ) |                                    | 6.0V                                       |
| Voltage on Input/Output Pins                                       |                                    | V <sup>+</sup> +0.3V, V <sup>-</sup> -0.3V |
| Storage Temperature Range  |                                    | -65°C to 150°C                             |
| Junction Temperature <sup>(4)</sup>                                |                                    | +150°C                                     |
| Soldering Information  | Infrared or Convection (20 sec)    | 235°C                                      |
|  | Wave Soldering Lead Temp. (10 sec) | 260°C                                      |

- (1) Absolute Maximum Ratings indicate limits beyond which damage to the device may occur. Operating Ratings indicate conditions for which the device is intended to be functional, but specific performance is not ensured. For ensured specifications and the test conditions, see the Electrical Characteristics Tables.
- (2) If Military/Aerospace specified devices are required, please contact the Texas Instruments Sales Office/ Distributors for availability and specifications.
- (3) Human Body Model, applicable std. MIL-STD-883, Method 3015.7. Machine Model, applicable std. JESD22-A115-A (ESD MM std. of JEDEC) Field-Induced Charge-Device Model, applicable std. JESD22-C101-C (ESD FICDM std. of JEDEC).
- (4) The maximum power dissipation is a function of T<sub>J(MAX)</sub>, θ<sub>JA</sub>. The maximum allowable power dissipation at any ambient temperature is P<sub>D</sub> = (T<sub>J(MAX)</sub> - T<sub>A</sub>)/θ<sub>JA</sub>. All numbers apply for packages soldered directly onto a PC Board.

### Operating Ratings<sup>(1)</sup>

|  |                                |                |
|--|--------------------------------|----------------|
| Temperature Range <sup>(2)</sup>                                   |                                | -40°C to 125°C |
| Supply Voltage (V <sub>S</sub> = V <sup>+</sup> – V <sup>-</sup> ) | 0°C ≤ T <sub>A</sub> ≤ 125°C   | 1.8V to 5.5V   |
|  | -40°C ≤ T <sub>A</sub> ≤ 125°C | 2.0V to 5.5V   |
| Package Thermal Resistance (θ <sub>JA</sub> <sup>(2)</sup> )       | 5-Pin SOT-23                   | 180°C/W        |
|  | 8-Pin VSSOP                    | 236°C/W        |

- (1) Absolute Maximum Ratings indicate limits beyond which damage to the device may occur. Operating Ratings indicate conditions for which the device is intended to be functional, but specific performance is not ensured. For ensured specifications and the test conditions, see the Electrical Characteristics Tables.
- (2) The maximum power dissipation is a function of T<sub>J(MAX)</sub>, θ<sub>JA</sub>. The maximum allowable power dissipation at any ambient temperature is P<sub>D</sub> = (T<sub>J(MAX)</sub> - T<sub>A</sub>)/θ<sub>JA</sub>. All numbers apply for packages soldered directly onto a PC Board.

## 2.5V Electrical Characteristics

Unless otherwise specified, all limits are ensured for  $T_A = 25^\circ\text{C}$ ,  $V^+ = 2.5\text{V}$ ,  $V^- = 0\text{V}$ ,  $V_O = V_{\text{CM}} = V^+/2$ . **Boldface** limits apply at the temperature extremes.

| Symbol             | Parameter  | Conditions   | Min <sup>(1)</sup>                                  | Typ <sup>(2)</sup> | Max <sup>(1)</sup>                       | Units                        |
|--------------------|--|--|---|--------------------|--|------------------------------|
| $V_{\text{OS}}$    | Input Offset Voltage                                     | $-20^\circ\text{C} \leq T_A \leq 85^\circ\text{C}$                                       |   | $\pm 20$           | $\pm 180$<br><b><math>\pm 330</math></b> | $\mu\text{V}$                |
|                    |  | $-40^\circ\text{C} \leq T_A \leq 125^\circ\text{C}$                                      |   | $\pm 20$           | $\pm 180$<br><b><math>\pm 430</math></b> |                              |
| TC $V_{\text{OS}}$ | Input Offset Voltage Temperature Drift <sup>(3)(4)</sup> | LMP7715  |   | -1                 | $\pm 4$                                  | $\mu\text{V}/^\circ\text{C}$ |
|                    |  | LMP7716/LMP7716Q   |   | -1.75              |  |                              |
| $I_{\text{B}}$     | Input Bias Current                                       | $V_{\text{CM}} = 1.0\text{V}^{(4)(5)}$   | $-40^\circ\text{C} \leq T_A \leq 85^\circ\text{C}$  | 0.05               | 1<br><b>25</b>                           | $\text{pA}$                  |
|                    |  |  | $-40^\circ\text{C} \leq T_A \leq 125^\circ\text{C}$ | 0.05               | 1<br><b>100</b>                          |                              |
| $I_{\text{OS}}$    | Input Offset Current                                     | $V_{\text{CM}} = 1\text{V}^{(4)}$  |   | 0.006              | 0.5<br><b>50</b>                         | $\text{pA}$                  |
| CMRR               | Common Mode Rejection Ratio                              | $0\text{V} \leq V_{\text{CM}} \leq 1.4\text{V}$  | 83<br><b>80</b>                                     | 100                |  | $\text{dB}$                  |
| PSRR               | Power Supply Rejection Ratio                             | $2.0\text{V} \leq V^+ \leq 5.5\text{V}$<br>$V^- = 0\text{V}$ , $V_{\text{CM}} = 0$       | 85<br><b>80</b>                                     | 100                |  | $\text{dB}$                  |
|                    |  | $1.8\text{V} \leq V^+ \leq 5.5\text{V}$<br>$V^- = 0\text{V}$ , $V_{\text{CM}} = 0$       | 85  | 98                 |  |                              |
| CMVR               | Common Mode Voltage Range                                | CMRR $\geq 80\text{ dB}$<br>CMRR $\geq 78\text{ dB}$                                     | -0.3<br><b>-0.3</b>                                 |                    | 1.5<br><b>1.5</b>                        | $\text{V}$                   |
| $A_{\text{VOL}}$   | Open Loop Voltage Gain                                   | LMP7715, $V_O = 0.15$ to $2.2\text{V}$<br>$R_L = 2\text{ k}\Omega$ to $V^+/2$            | 88<br><b>82</b>                                     | 98                 |  | $\text{dB}$                  |
|                    |  | LMP7716/LMP7716Q, $V_O = 0.15$ to $2.2\text{V}$<br>$R_L = 2\text{ k}\Omega$ to $V^+/2$   | 84<br><b>80</b>                                     | 92                 |  |                              |
|                    |  | LMP7715, $V_O = 0.15$ to $2.2\text{V}$<br>$R_L = 10\text{ k}\Omega$ to $V^+/2$           | 92<br><b>88</b>                                     | 110                |  |                              |
|                    |  | LMP7716/ LMP7716Q, $V_O = 0.15$ to $2.2\text{V}$<br>$R_L = 10\text{ k}\Omega$ to $V^+/2$ | 90<br><b>86</b>                                     | 95                 |  |                              |
| $V_{\text{OUT}}$   | Output Voltage Swing High                                | $R_L = 2\text{ k}\Omega$ to $V^+/2$  |   | 25                 | 70<br><b>77</b>                          | mV from either rail          |
|                    |  | $R_L = 10\text{ k}\Omega$ to $V^+/2$   |   | 20                 | 60<br><b>66</b>                          |                              |
|                    | Output Voltage Swing Low                                 | $R_L = 2\text{ k}\Omega$ to $V^+/2$  |   | 30                 | 70<br><b>73</b>                          |                              |
|                    |  | $R_L = 10\text{ k}\Omega$ to $V^+/2$   |   | 15                 | 60<br><b>62</b>                          |                              |
| $I_{\text{OUT}}$   | Output Current   | Sourcing to $V^-$<br>$V_{\text{IN}} = 200\text{ mV}^{(6)}$                               | 36<br><b>30</b>                                     | 52                 |  | $\text{mA}$                  |
|                    |  | Sinking to $V^+$<br>$V_{\text{IN}} = -200\text{ mV}^{(6)}$                               | 7.5<br><b>5.0</b>                                   | 15                 |  |                              |
| $I_{\text{S}}$     | Supply Current   | LMP7715  |   | 0.95               | 1.30<br><b>1.65</b>                      | $\text{mA}$                  |
|                    |  | LMP7716/LMP7716Q (per channel)   |   | 1.10               | 1.50<br><b>1.85</b>                      |                              |
| SR                 | Slew Rate  | $A_V = +1$ , Rising (10% to 90%)   |   | 8.3                |  | $\text{V}/\mu\text{s}$       |
|                    |  | $A_V = +1$ , Falling (90% to 10%)  |   | 10.3               |  |                              |

- (1) Limits are 100% production tested at  $25^\circ\text{C}$ . Limits over the operating temperature range are specified through correlations using the Statistical Quality Control (SQC) method.
- (2) Typical values represent the most likely parametric norm as determined at the time of characterization. Actual typical values may vary over time and will also depend on the application and configuration. The typical values are not tested and are not specified on shipped production material.
- (3) Offset voltage average drift is determined by dividing the change in  $V_{\text{OS}}$  at the temperature extremes by the total temperature change.
- (4) This parameter is specified by design and/or characterization and is not tested in production.
- (5) Positive current corresponds to current flowing into the device.
- (6) The short circuit test is a momentary open loop test.

## 2.5V Electrical Characteristics (continued)

Unless otherwise specified, all limits are ensured for  $T_A = 25^\circ\text{C}$ ,  $V^+ = 2.5\text{V}$ ,  $V^- = 0\text{V}$ ,  $V_O = V_{\text{CM}} = V^+/2$ . **Boldface** limits apply at the temperature extremes.

| Symbol | Parameter                            | Conditions   | Min <sup>(1)</sup> | Typ <sup>(2)</sup> | Max <sup>(1)</sup> | Units                  |
|--------|--------------------------------------|--|--------------------|--------------------|--------------------|------------------------|
| GBW    | Gain Bandwidth                       |  |                    | 14                 |                    | MHz                    |
| $e_n$  | Input Referred Voltage Noise Density | $f = 400\text{ Hz}$  |                    | 6.8                |                    | nV/                    |
|        |                                      | $f = 1\text{ kHz}$   |                    | 5.8                |                    |                        |
| $i_n$  | Input Referred Current Noise Density | $f = 1\text{ kHz}$   |                    | 0.01               |                    | pA/ $\sqrt{\text{Hz}}$ |
| THD+N  | Total Harmonic Distortion + Noise    | $f = 1\text{ kHz}$ , $A_V = 1$ , $R_L = 100\text{ k}\Omega$<br>$V_O = 0.9 V_{\text{PP}}$ |                    | 0.003              |                    | %                      |
|        |                                      | $f = 1\text{ kHz}$ , $A_V = 1$ , $R_L = 600\Omega$<br>$V_O = 0.9 V_{\text{PP}}$          |                    | 0.004              |                    |                        |

## 5V Electrical Characteristics

Unless otherwise specified, all limits are ensured for  $T_A = 25^\circ\text{C}$ ,  $V^+ = 5\text{V}$ ,  $V^- = 0\text{V}$ ,  $V_{\text{CM}} = V^+/2$ . **Boldface** limits apply at the temperature extremes.

| Symbol             | Parameter  | Conditions   | Min <sup>(1)</sup>                                  | Typ <sup>(2)</sup> | Max <sup>(1)</sup>                       | Units                        |
|--------------------|--|--|---|--------------------|--|------------------------------|
| $V_{\text{OS}}$    | Input Offset Voltage                                     | $-20^\circ\text{C} \leq T_A \leq 85^\circ\text{C}$   |   | $\pm 10$           | $\pm 150$<br><b><math>\pm 300</math></b> | $\mu\text{V}$                |
|                    |  | $-40^\circ\text{C} \leq T_A \leq 125^\circ\text{C}$  |   | $\pm 10$           | $\pm 150$<br><b><math>\pm 400</math></b> |                              |
| TC $V_{\text{OS}}$ | Input Offset Voltage Temperature Drift <sup>(3)(4)</sup> | LMP7715  |   | -1                 | $\pm 4$                                  | $\mu\text{V}/^\circ\text{C}$ |
|                    |  | LMP7716/LMP7716Q   |   | -1.75              |  |                              |
| $I_B$              | Input Bias Current                                       | $V_{\text{CM}} = 2.0\text{V}^{(4)(5)}$   | $-40^\circ\text{C} \leq T_A \leq 85^\circ\text{C}$  | 0.1                | 1<br><b>25</b>                           | pA                           |
|                    |  |  | $-40^\circ\text{C} \leq T_A \leq 125^\circ\text{C}$ | 0.1                | 1<br><b>100</b>                          |                              |
| $I_{\text{OS}}$    | Input Offset Current                                     | $V_{\text{CM}} = 2.0\text{V}^{(4)}$  |   | 0.01               | 0.5<br><b>50</b>                         | pA                           |
| CMRR               | Common Mode Rejection Ratio                              | $0\text{V} \leq V_{\text{CM}} \leq 3.7\text{V}$  | 85<br><b>82</b>                                     | 100                |  | dB                           |
| PSRR               | Power Supply Rejection Ratio                             | $2.0\text{V} \leq V^+ \leq 5.5\text{V}$<br>$V^- = 0\text{V}$ , $V_{\text{CM}} = 0$               | 85<br><b>80</b>                                     | 100                |  | dB                           |
|                    |  | $1.8\text{V} \leq V^+ \leq 5.5\text{V}$<br>$V^- = 0\text{V}$ , $V_{\text{CM}} = 0$               | 85  | 98                 |  |                              |
| CMVR               | Common Mode Voltage Range                                | CMRR $\geq 80\text{ dB}$<br>CMRR $\geq 78\text{ dB}$   | -0.3<br><b>-0.3</b>                                 |                    | 4<br><b>4</b>                            | V                            |
| $A_{\text{VOL}}$   | Open Loop Voltage Gain                                   | LMP7715, $V_O = 0.3\text{ to }4.7\text{V}$<br>$R_L = 2\text{ k}\Omega\text{ to }V^+/2$           | 88<br><b>82</b>                                     | 107                |  | dB                           |
|                    |  | LMP7716/LMP7716Q, $V_O = 0.3\text{ to }4.7\text{V}$<br>$R_L = 2\text{ k}\Omega\text{ to }V^+/2$  | 84<br><b>80</b>                                     | 90                 |  |                              |
|                    |  | LMP7715, $V_O = 0.3\text{ to }4.7\text{V}$<br>$R_L = 10\text{ k}\Omega\text{ to }V^+/2$          | 92<br><b>88</b>                                     | 110                |  |                              |
|                    |  | LMP7716/LMP7716Q, $V_O = 0.3\text{ to }4.7\text{V}$<br>$R_L = 10\text{ k}\Omega\text{ to }V^+/2$ | 90<br><b>86</b>                                     | 95                 |  |                              |

- (1) Limits are 100% production tested at  $25^\circ\text{C}$ . Limits over the operating temperature range are specified through correlations using the Statistical Quality Control (SQC) method.
- (2) Typical values represent the most likely parametric norm as determined at the time of characterization. Actual typical values may vary over time and will also depend on the application and configuration. The typical values are not tested and are not specified on shipped production material.
- (3) Offset voltage average drift is determined by dividing the change in  $V_{\text{OS}}$  at the temperature extremes by the total temperature change.
- (4) This parameter is specified by design and/or characterization and is not tested in production.
- (5) Positive current corresponds to current flowing into the device.

**5V Electrical Characteristics (continued)**

Unless otherwise specified, all limits are ensured for  $T_A = 25^\circ\text{C}$ ,  $V^+ = 5\text{V}$ ,  $V^- = 0\text{V}$ ,  $V_{\text{CM}} = V^+/2$ . **Boldface** limits apply at the temperature extremes.

| Symbol           | Parameter                            | Conditions  | Min <sup>(1)</sup> | Typ <sup>(2)</sup> | Max <sup>(1)</sup>  | Units                        |
|------------------|--------------------------------------|---|--------------------|--------------------|---------------------|------------------------------|
| $V_{\text{OUT}}$ | Output Voltage Swing High            | $R_L = 2\text{ k}\Omega$ to $V^+/2$   |                    | 32                 | 70<br><b>77</b>     | mV from either rail          |
|                  |                                      | $R_L = 10\text{ k}\Omega$ to $V^+/2$  |                    | 22                 | 60<br><b>66</b>     |                              |
|                  | Output Voltage Swing Low             | $R_L = 2\text{ k}\Omega$ to $V^+/2$<br>(LMP7715)  |                    | 42                 | 70<br><b>73</b>     |                              |
|                  |                                      | $R_L = 2\text{ k}\Omega$ to $V^+/2$<br>(LMP7716/LMP7716Q)                                     |                    | 45                 | 75<br><b>78</b>     |                              |
|                  |                                      | $R_L = 10\text{ k}\Omega$ to $V^+/2$  |                    | 20                 | 60<br><b>62</b>     |                              |
| $I_{\text{OUT}}$ | Output Current                       | Sourcing to $V^-$<br>$V_{\text{IN}} = 200\text{ mV}^{(6)}$                                    | 46<br><b>38</b>    | 66                 |                     | mA                           |
|                  |                                      | Sinking to $V^+$<br>$V_{\text{IN}} = -200\text{ mV}^{(6)}$                                    | 10.5<br><b>6.5</b> | 23                 |                     |                              |
| $I_S$            | Supply Current                       | LMP7715   |                    | 1.15               | 1.40<br><b>1.75</b> | mA                           |
|                  |                                      | LMP7716/LMP7716Q (per channel)  |                    | 1.30               | 1.70<br><b>2.05</b> |                              |
| SR               | Slew Rate                            | $A_V = +1$ , Rising (10% to 90%)  | 6.0                | 9.5                |                     | $\text{V}/\mu\text{s}$       |
|                  |                                      | $A_V = +1$ , Falling (90% to 10%)   | 7.5                | 11.5               |                     |                              |
| GBW              | Gain Bandwidth                       |   |                    | 17                 |                     | MHz                          |
| $e_n$            | Input Referred Voltage Noise Density | $f = 400\text{ Hz}$   |                    | 7.0                |                     | $\text{nV}/\sqrt{\text{Hz}}$ |
|                  |                                      | $f = 1\text{ kHz}$  |                    | 5.8                |                     |                              |
| $i_n$            | Input Referred Current Noise Density | $f = 1\text{ kHz}$  |                    | 0.01               |                     | $\text{pA}/\sqrt{\text{Hz}}$ |
| THD+N            | Total Harmonic Distortion + Noise    | $f = 1\text{ kHz}$ , $A_V = 1$ , $R_L = 100\text{ k}\Omega$<br>$V_O = 4\text{ V}_{\text{PP}}$ |                    | 0.001              |                     | %                            |
|                  |                                      | $f = 1\text{ kHz}$ , $A_V = 1$ , $R_L = 600\Omega$<br>$V_O = 4\text{ V}_{\text{PP}}$          |                    | 0.004              |                     |                              |

(6) The short circuit test is a momentary open loop test.

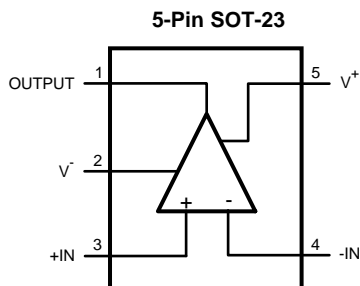
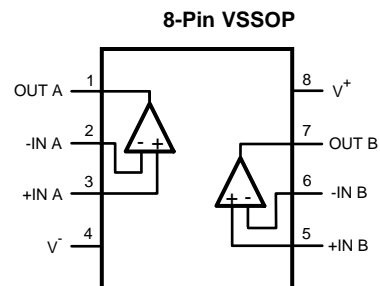
**Connection Diagram**

**Figure 3. Top View**

**Figure 4. Top View**

### Typical Performance Characteristics

Unless otherwise noted:  $T_A = 25^\circ\text{C}$ ,  $V_S = 5\text{V}$ ,  $V_{CM} = V_S/2$ .

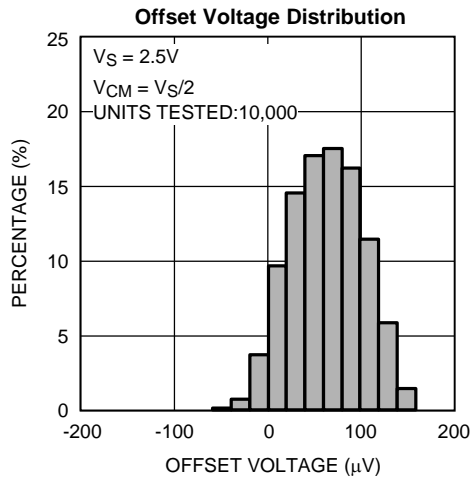

Figure 5.

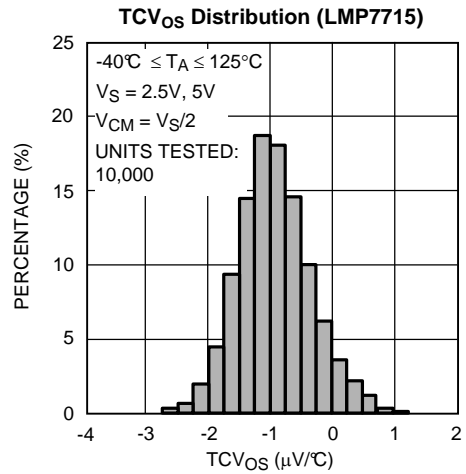

Figure 6.

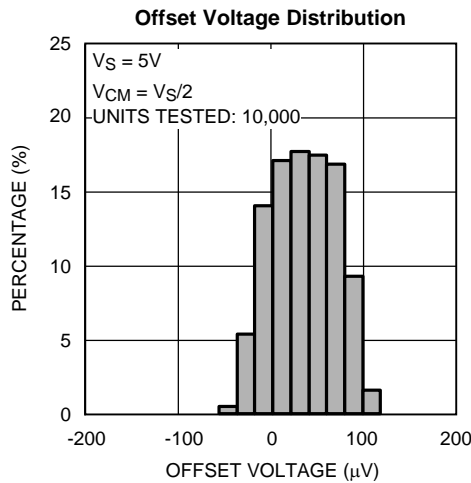

Figure 7.

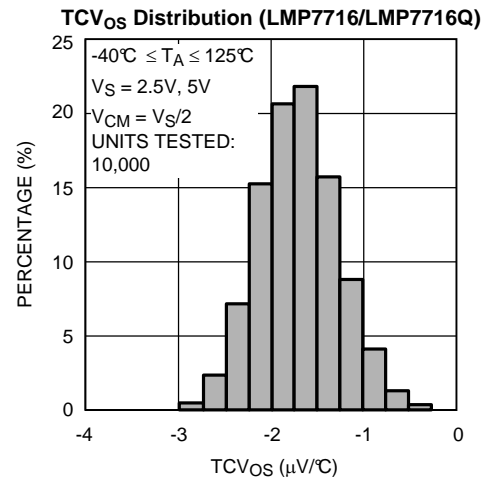

Figure 8.

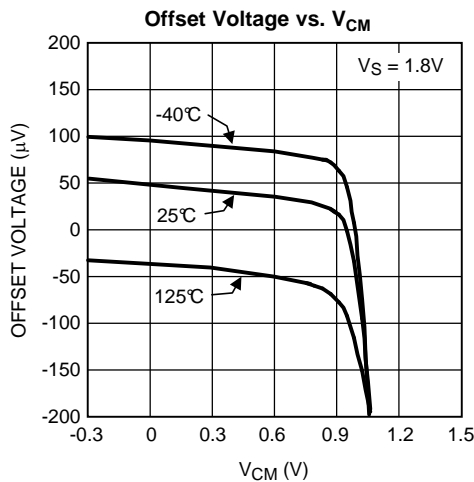

Figure 9.

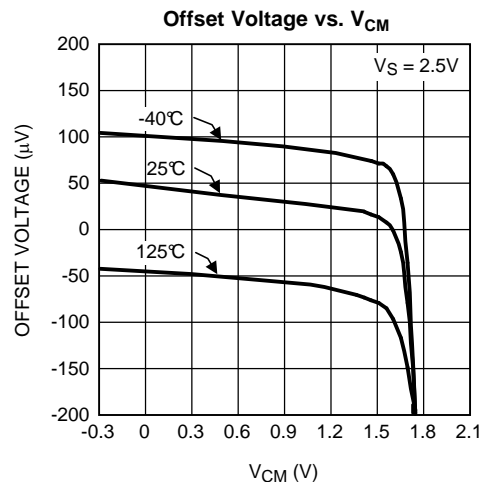

Figure 10.

**Typical Performance Characteristics (continued)**

Unless otherwise noted:  $T_A = 25^\circ\text{C}$ ,  $V_S = 5\text{V}$ ,  $V_{CM} = V_S/2$ .

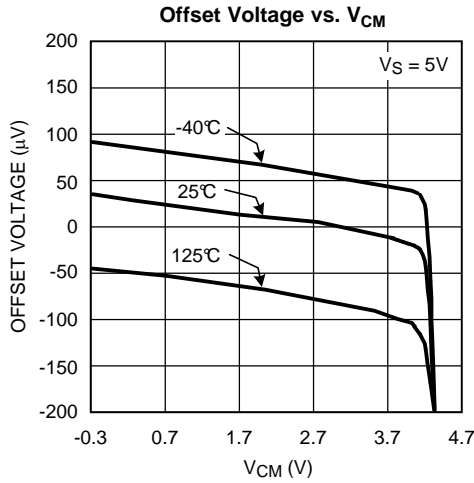

Figure 11.

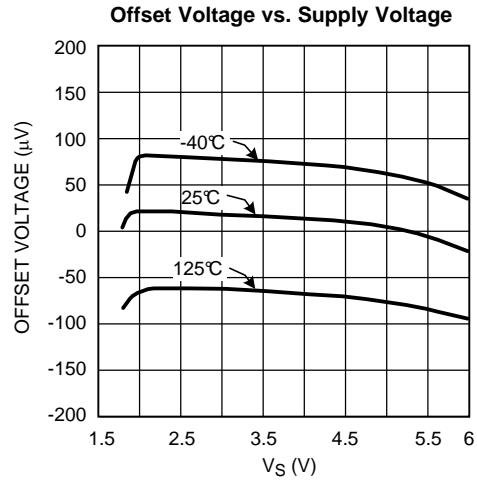

Figure 12.

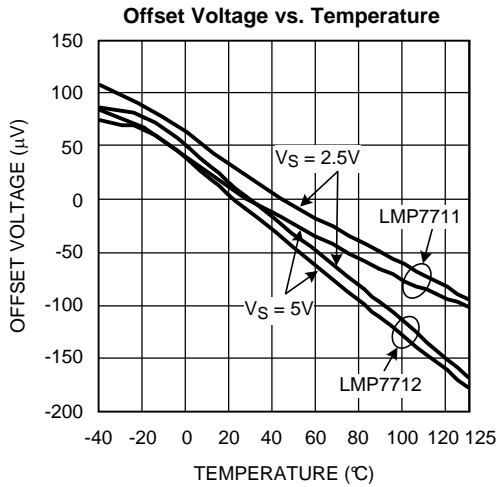

Figure 13.

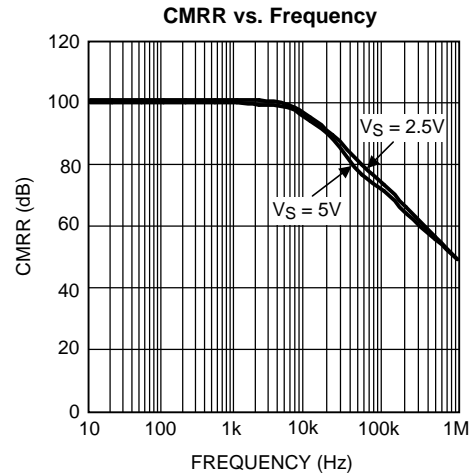

Figure 14.

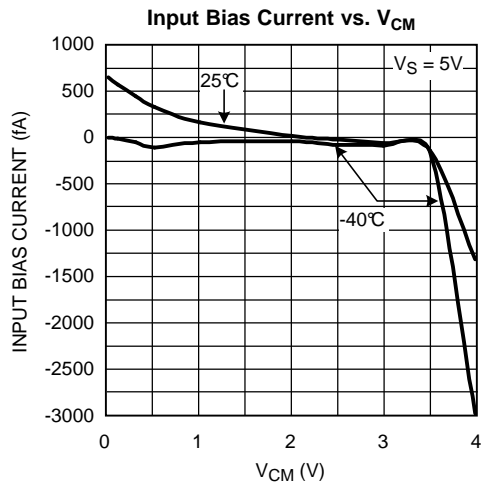

Figure 15.

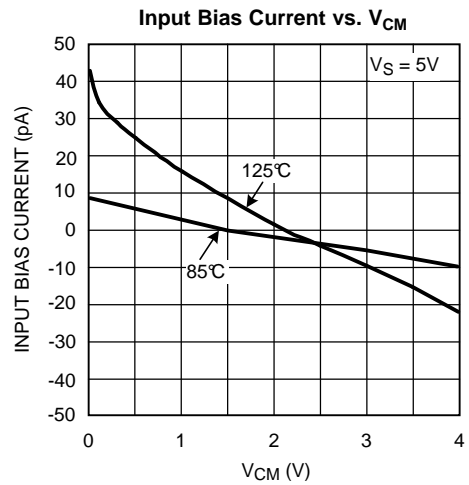

Figure 16.

**Typical Performance Characteristics (continued)**

Unless otherwise noted:  $T_A = 25^\circ\text{C}$ ,  $V_S = 5\text{V}$ ,  $V_{CM} = V_S/2$ .

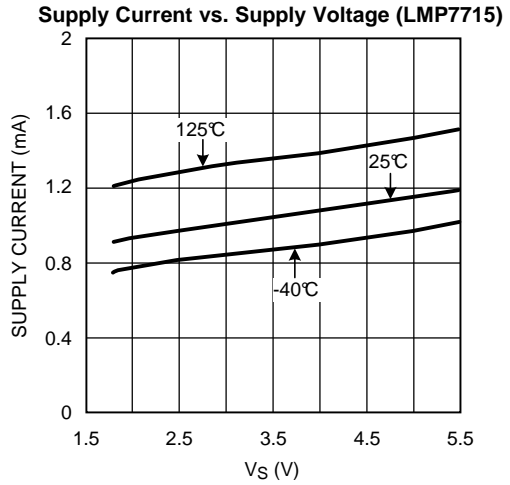

Figure 17.

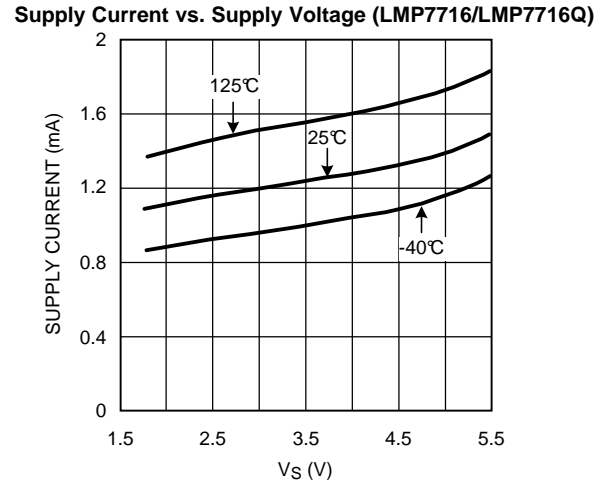

Figure 18.

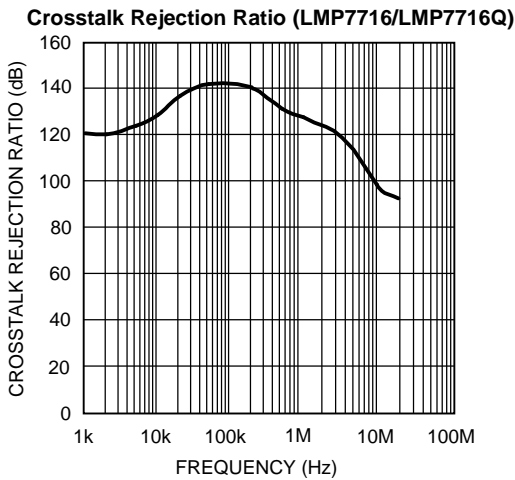

Figure 19.

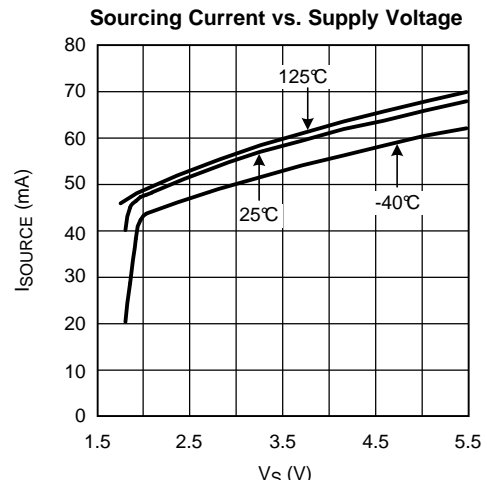

Figure 20.

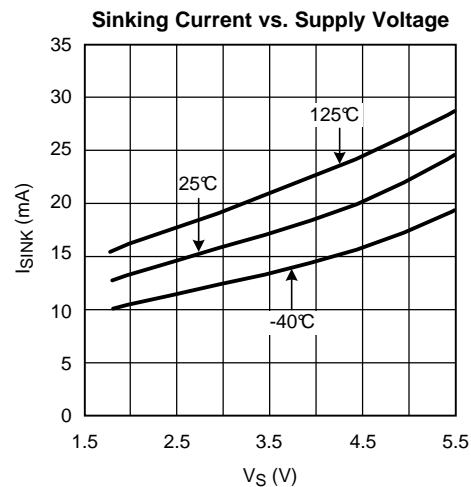

Figure 21.

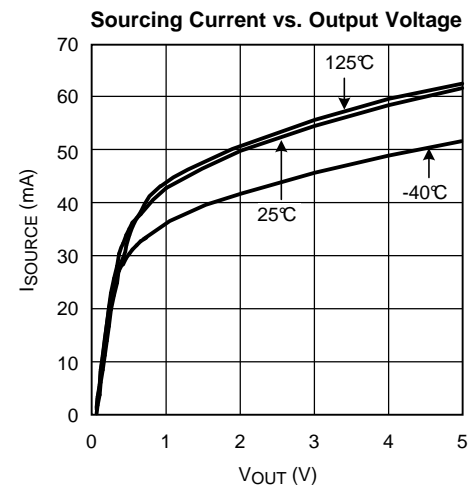

Figure 22.



Typical Performance Characteristics (continued)

Unless otherwise noted:  $T_A = 25^\circ\text{C}$ ,  $V_S = 5\text{V}$ ,  $V_{CM} = V_S/2$ .

Sinking Current vs. Output Voltage

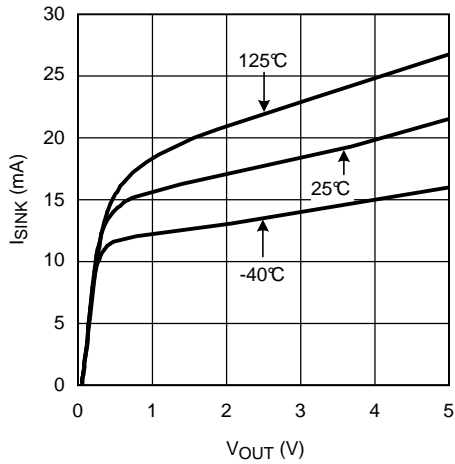

Figure 23.

Output Swing High vs. Supply Voltage

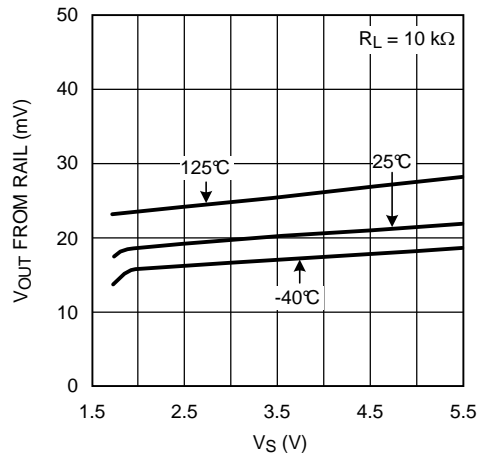

Figure 24.

Output Swing Low vs. Supply Voltage

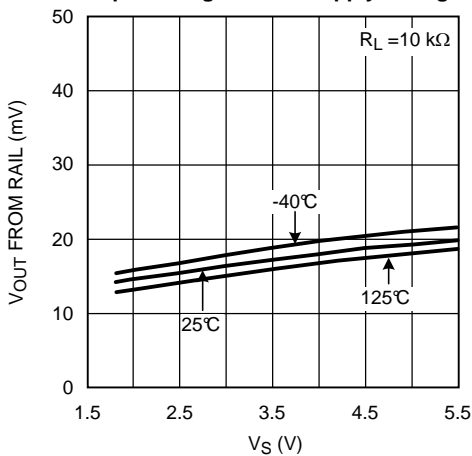

Figure 25.

Output Swing High vs. Supply Voltage

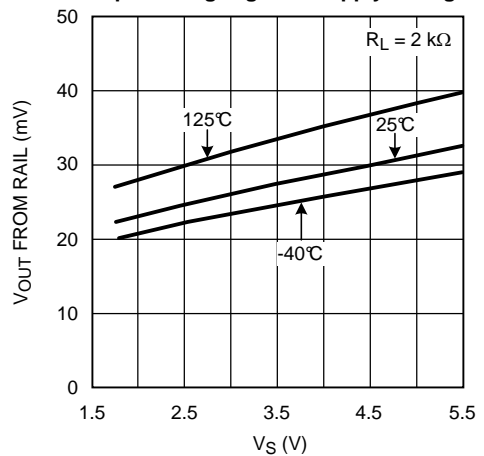

Figure 26.

Output Swing Low vs. Supply Voltage

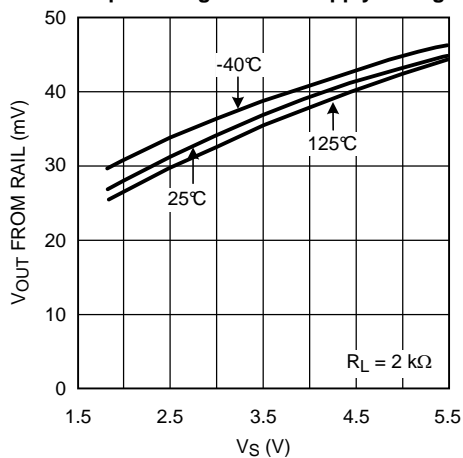

Figure 27.

Output Swing High vs. Supply Voltage

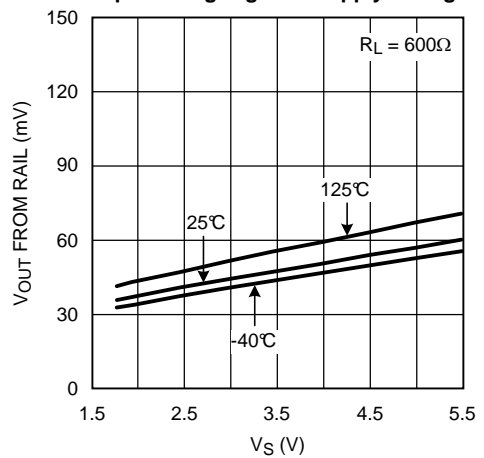

Figure 28.

**Typical Performance Characteristics (continued)**

Unless otherwise noted:  $T_A = 25^\circ\text{C}$ ,  $V_S = 5\text{V}$ ,  $V_{CM} = V_S/2$ .

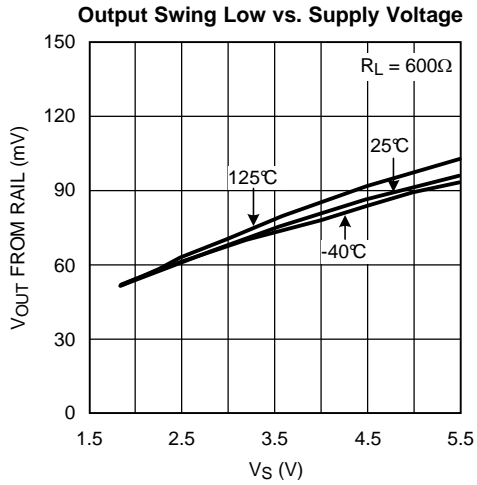

Figure 29.

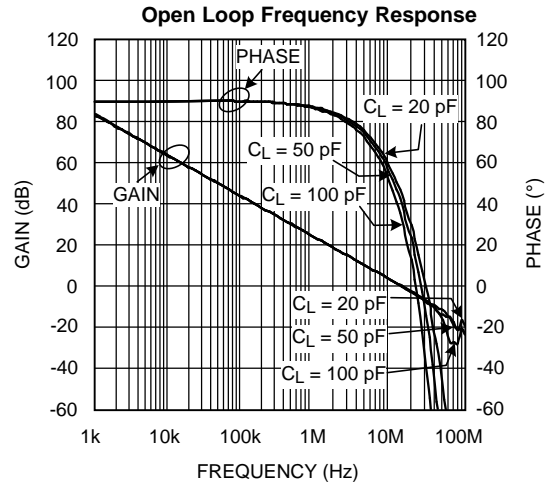

Figure 30.

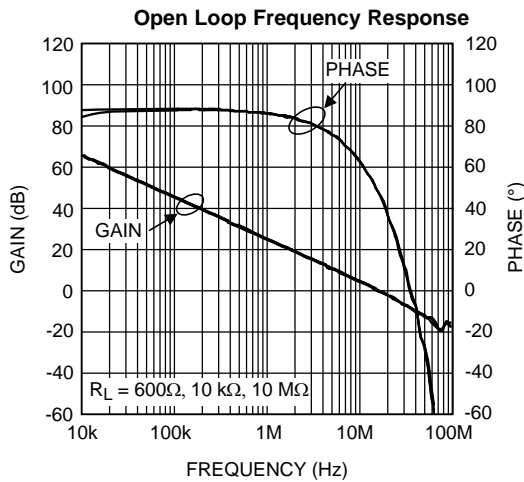

Figure 31.

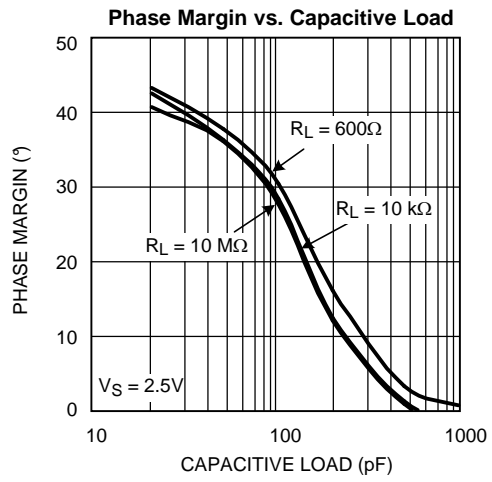

Figure 32.

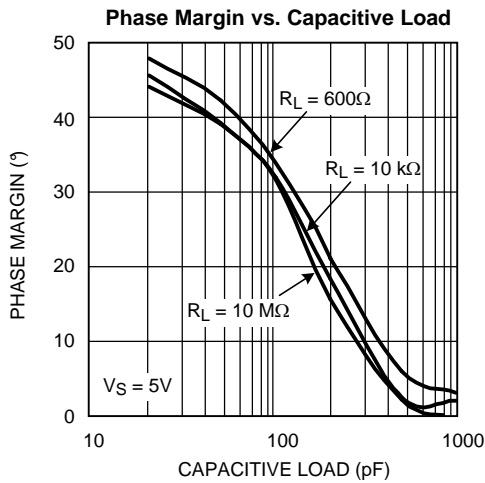

Figure 33.

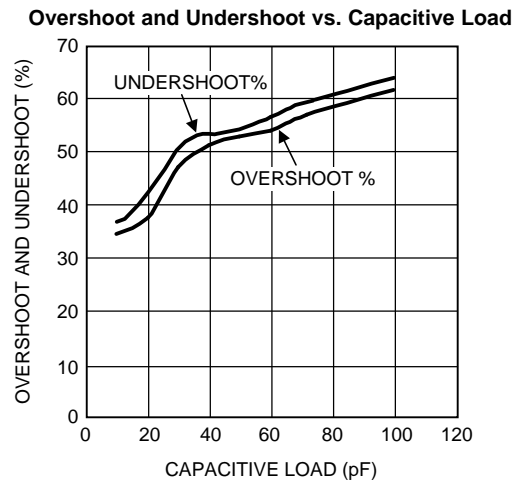

Figure 34.

Typical Performance Characteristics (continued)

Unless otherwise noted:  $T_A = 25^\circ\text{C}$ ,  $V_S = 5\text{V}$ ,  $V_{CM} = V_S/2$ .

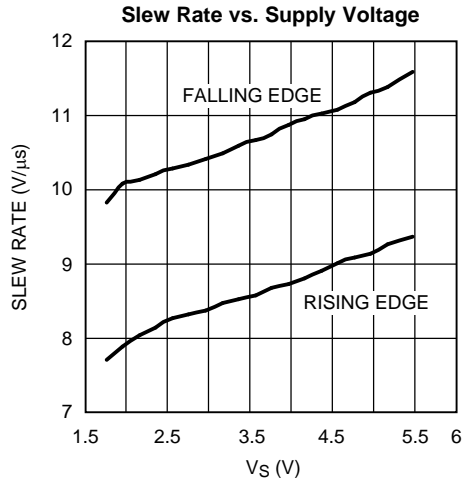

Figure 35.

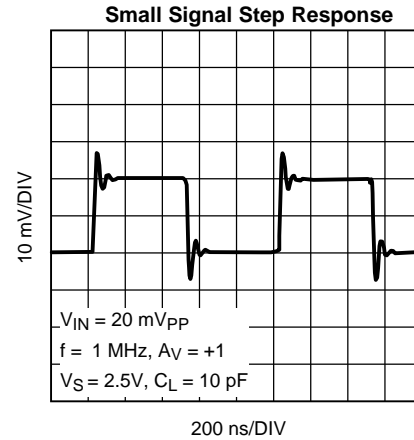

Figure 36.

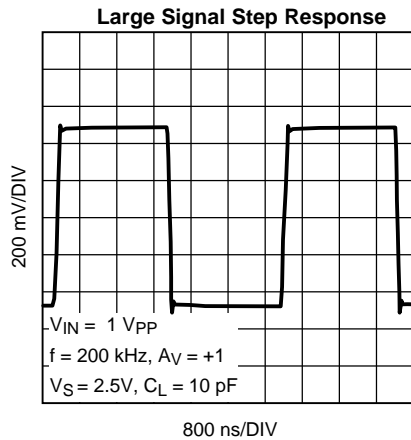

Figure 37.

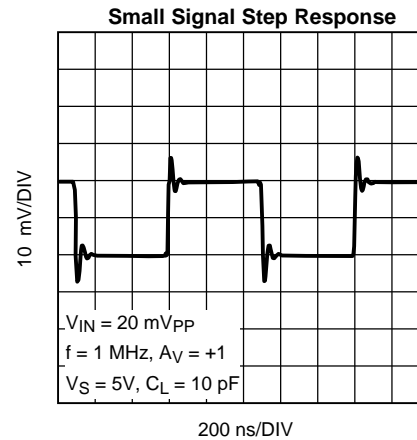

Figure 38.

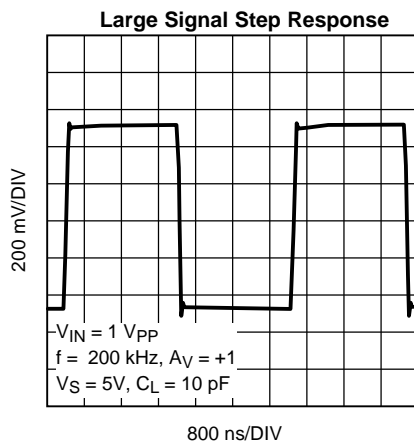

Figure 39.

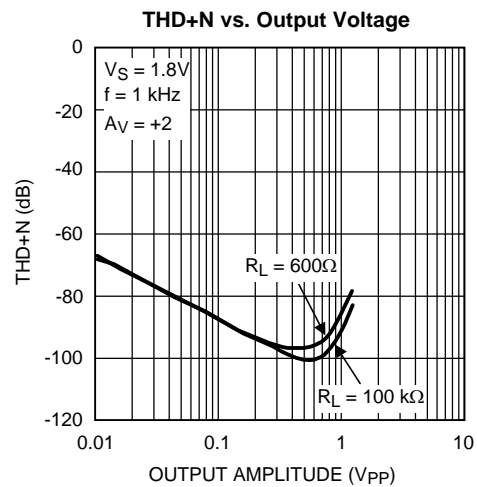

Figure 40.

**Typical Performance Characteristics (continued)**

Unless otherwise noted:  $T_A = 25^\circ\text{C}$ ,  $V_S = 5\text{V}$ ,  $V_{CM} = V_S/2$ .

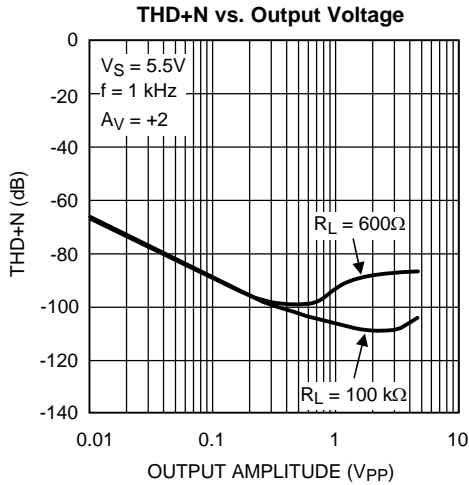

Figure 41.

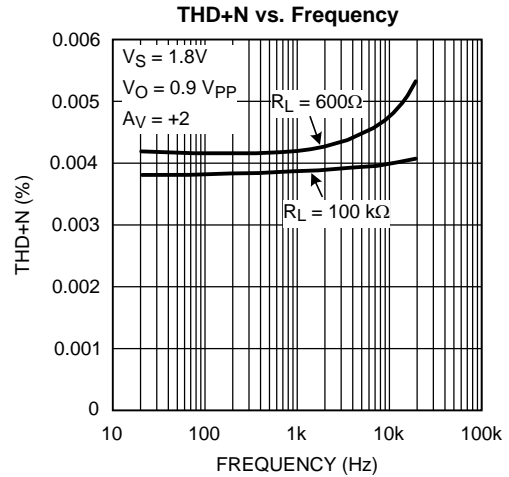

Figure 42.

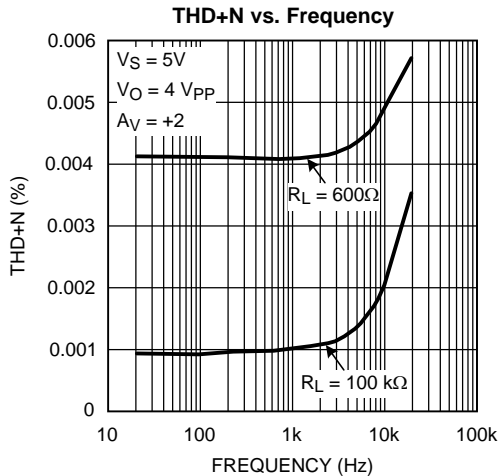

Figure 43.

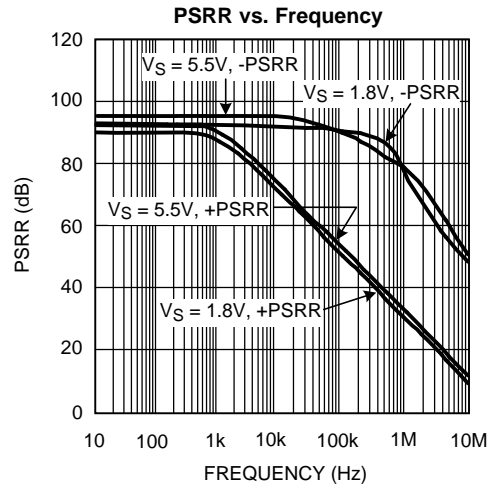

Figure 44.

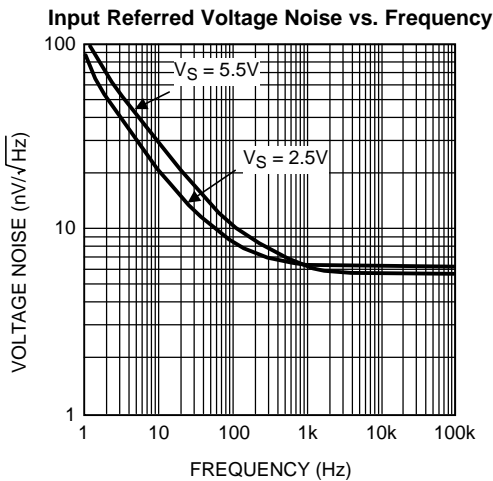

Figure 45.

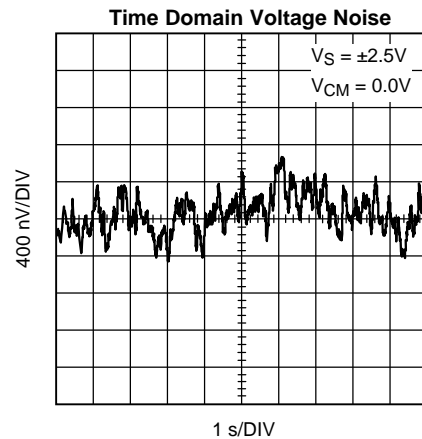
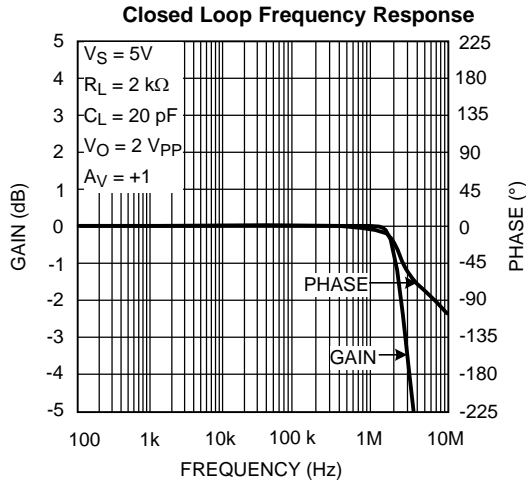

Figure 46.

**Typical Performance Characteristics (continued)**

Unless otherwise noted:  $T_A = 25^\circ\text{C}$ ,  $V_S = 5\text{V}$ ,  $V_{CM} = V_S/2$ .



**Figure 47.**

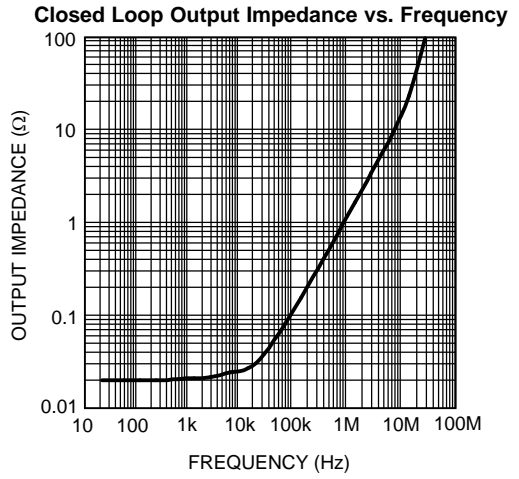

**Figure 48.**

## APPLICATION INFORMATION

### LMP7715/LMP7716/LMP7716Q

The LMP7715/LMP7716/LMP7716Q are single and dual, low noise, low offset, rail-to-rail output precision amplifiers with a wide gain bandwidth product of 17 MHz and low supply current. The wide bandwidth makes the LMP7715/LMP7716/LMP7716Q ideal choices for wide-band amplification in portable applications.

The LMP7715/LMP7716/LMP7716Q are superior for sensor applications. The very low input referred voltage noise of only  $5.8 \text{ nV}/\sqrt{\text{Hz}}$  at 1 kHz and very low input referred current noise of only  $10 \text{ fA}/\sqrt{\text{Hz}}$  mean more signal fidelity and higher signal-to-noise ratio.

The LMP7715/LMP7716/LMP7716Q have a supply voltage range of 1.8V to 5.5V over a wide temperature range of  $0^\circ\text{C}$  to  $125^\circ\text{C}$ . This is optimal for low voltage commercial applications. For applications where the ambient temperature might be less than  $0^\circ\text{C}$ , the LMP7715/LMP7716/LMP7716Q are fully operational at supply voltages of 2.0V to 5.5V over the temperature range of  $-40^\circ\text{C}$  to  $125^\circ\text{C}$ .

The outputs of the LMP7715/LMP7716/LMP7716Q swing within 25 mV of either rail providing maximum dynamic range in applications requiring low supply voltage. The input common mode range of the LMP7715/LMP7716/LMP7716Q extends to 300 mV below ground. This feature enables users to utilize this device in single supply applications.

The use of a very innovative feedback topology has enhanced the current drive capability of the LMP7715/LMP7716/LMP7716Q, resulting in sourcing currents of as much as 47 mA with a supply voltage of only 1.8V.

The LMP7715 is offered in the space saving SOT-23 package and the LMP7716/LMP7716Q is offered in an 8-pin VSSOP. These small packages are ideal solutions for applications requiring minimum PC board footprint.

### CAPACITIVE LOAD

The unity gain follower is the most sensitive configuration to capacitive loading. The combination of a capacitive load placed directly on the output of an amplifier along with the output impedance of the amplifier creates a phase lag which in turn reduces the phase margin of the amplifier. If phase margin is significantly reduced, the response will be either underdamped or the amplifier will oscillate.

The LMP7715/LMP7716/LMP7716Q can directly drive capacitive loads of up to 120 pF without oscillating. To drive heavier capacitive loads, an isolation resistor,  $R_{\text{ISO}}$  as shown in [Figure 49](#), should be used. This resistor and  $C_L$  form a pole and hence delay the phase lag or increase the phase margin of the overall system. The larger the value of  $R_{\text{ISO}}$ , the more stable the output voltage will be. However, larger values of  $R_{\text{ISO}}$  result in reduced output swing and reduced output current drive.

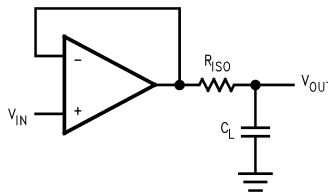

**Figure 49. Isolating Capacitive Load**

### INPUT CAPACITANCE

CMOS input stages inherently have low input bias current and higher input referred voltage noise. The LMP7715/LMP7716/LMP7716Q enhance this performance by having the low input bias current of only 50 fA, as well as, a very low input referred voltage noise of  $5.8 \text{ nV}/\sqrt{\text{Hz}}$ . In order to achieve this a larger input stage has been used. This larger input stage increases the input capacitance of the LMP7715/LMP7716/LMP7716Q. [Figure 50](#) shows typical input common mode capacitance of the LMP7715/LMP7716/LMP7716Q.

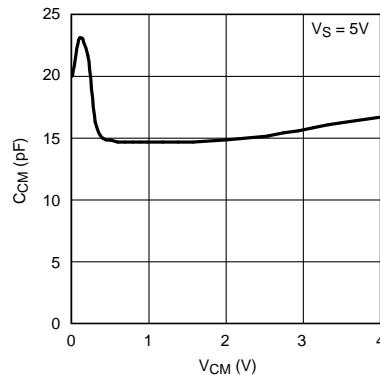
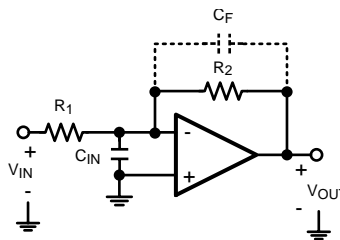

Figure 50. Input Common Mode Capacitance

This input capacitance will interact with other impedances, such as gain and feedback resistors which are seen on the inputs of the amplifier, to form a pole. This pole will have little or no effect on the output of the amplifier at low frequencies and under DC conditions, but will play a bigger role as the frequency increases. At higher frequencies, the presence of this pole will decrease phase margin and also cause gain peaking. In order to compensate for the input capacitance, care must be taken in choosing feedback resistors. In addition to being selective in picking values for the feedback resistor, a capacitor can be added to the feedback path to increase stability.

The DC gain of the circuit shown in Figure 51 is simply  $-R_2/R_1$ .



$$A_V = - \frac{V_{OUT}}{V_{IN}} = - \frac{R_2}{R_1}$$

Figure 51. Compensating for Input Capacitance

For the time being, ignore  $C_F$ . The AC gain of the circuit in Figure 51 can be calculated as follows:

$$\frac{V_{OUT}}{V_{IN}}(s) = \frac{-R_2/R_1}{1 + \frac{s}{\left(\frac{A_0 R_1}{R_1 + R_2}\right)} + \frac{s^2}{\left(\frac{A_0}{C_{IN} R_2}\right)}} \quad (1)$$

This equation is rearranged to find the location of the two poles:

$$P_{1,2} = \frac{-1}{2C_{IN}} \left[ \frac{1}{R_1} + \frac{1}{R_2} \pm \sqrt{\left(\frac{1}{R_1} + \frac{1}{R_2}\right)^2 - \frac{4 A_0 C_{IN}}{R_2}} \right] \quad (2)$$

As shown in Equation 2, as the values of  $R_1$  and  $R_2$  are increased, the magnitude of the poles are reduced, which in turn decreases the bandwidth of the amplifier. Figure 52 shows the frequency response with different value resistors for  $R_1$  and  $R_2$ . Whenever possible, it is best to chose smaller feedback resistors.

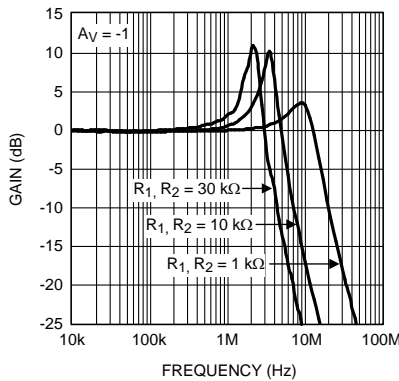

**Figure 52. Closed Loop Frequency Response**

As mentioned before, adding a capacitor to the feedback path will decrease the peaking. This is because  $C_F$  will form yet another pole in the system and will prevent pairs of poles, or complex conjugates from forming. It is the presence of pairs of poles that cause the peaking of gain. Figure 53 shows the frequency response of the schematic presented in Figure 51 with different values of  $C_F$ . As can be seen, using a small value capacitor significantly reduces or eliminates the peaking.

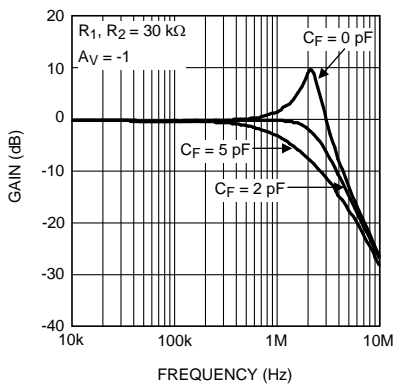

**Figure 53. Closed Loop Frequency Response**

## TRANSIMPEDANCE AMPLIFIER

In many applications the signal of interest is a very small amount of current that needs to be detected. Current that is transmitted through a photodiode is a good example. Barcode scanners, light meters, fiber optic receivers, and industrial sensors are some typical applications utilizing photodiodes for current detection. This current needs to be amplified before it can be further processed. This amplification is performed using a current-to-voltage converter configuration or transimpedance amplifier. The signal of interest is fed to the inverting input of an op amp with a feedback resistor in the current path. The voltage at the output of this amplifier will be equal to the negative of the input current times the value of the feedback resistor. Figure 54 shows a transimpedance amplifier configuration.  $C_D$  represents the photodiode parasitic capacitance and  $C_{CM}$  denotes the common-mode capacitance of the amplifier. The presence of all of these capacitances at higher frequencies might lead to less stable topologies at higher frequencies. Care must be taken when designing a transimpedance amplifier to prevent the circuit from oscillating.

With a wide gain bandwidth product, low input bias current and low input voltage and current noise, the LMP7715/LMP7716/LMP7716Q are ideal for wideband transimpedance applications.



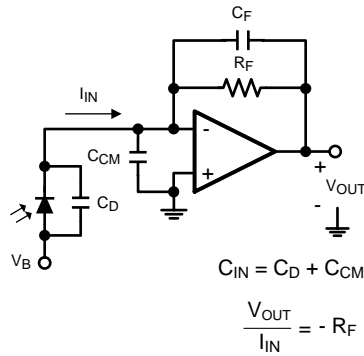
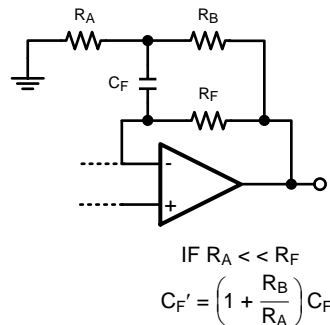

**Figure 54. Transimpedance Amplifier**

A feedback capacitance  $C_F$  is usually added in parallel with  $R_F$  to maintain circuit stability and to control the frequency response. To achieve a maximally flat, 2<sup>nd</sup> order response,  $R_F$  and  $C_F$  should be chosen by using [Equation 3](#)

$$C_F = \sqrt{\frac{C_{IN}}{GBWP * 2 \pi R_F}} \quad (3)$$

Calculating  $C_F$  from [Equation 3](#) can sometimes result in capacitor values which are less than 2 pF. This is especially the case for high speed applications. In these instances, it is often more practical to use the circuit shown in [Figure 55](#) in order to allow more sensible choices for  $C_F$ . The new feedback capacitor,  $C_F'$ , is  $(1 + R_B/R_A) C_F$ . This relationship holds as long as  $R_A \ll R_F$ .

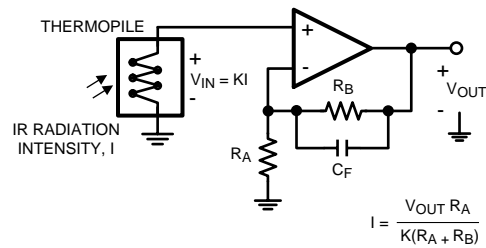

**Figure 55. Modified Transimpedance Amplifier**

## SENSOR INTERFACE

The LMP7715/LMP7716/LMP7716Q have low input bias current and low input referred noise, which make them ideal choices for sensor interfaces such as thermopiles, Infra Red (IR) thermometry, thermocouple amplifiers, and pH electrode buffers.

Thermopiles generate voltage in response to receiving radiation. These voltages are often only a few microvolts. As a result, the operational amplifier used for this application needs to have low offset voltage, low input voltage noise, and low input bias current. [Figure 56](#) shows a thermopile application where the sensor detects radiation from a distance and generates a voltage that is proportional to the intensity of the radiation. The two resistors,  $R_A$  and  $R_B$ , are selected to provide high gain to amplify this signal, while  $C_F$  removes the high frequency noise.

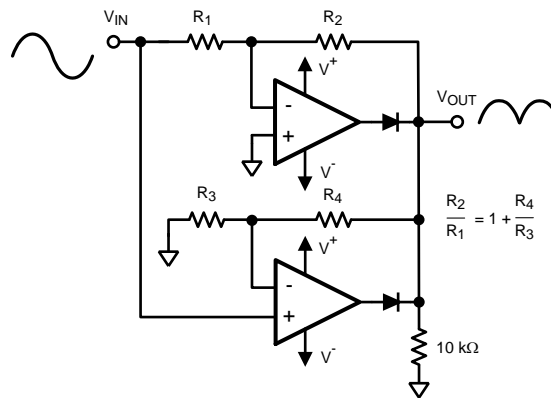

**Figure 56. Thermopile Sensor Interface**

## PRECISION RECTIFIER

Rectifiers are electrical circuits used for converting AC signals to DC signals. [Figure 57](#) shows a full-wave precision rectifier. Each operational amplifier used in this circuit has a diode on its output. This means for the diodes to conduct, the output of the amplifier needs to be positive with respect to ground. If  $V_{IN}$  is in its positive half cycle then only the output of the bottom amplifier will be positive. As a result, the diode on the output of the bottom amplifier will conduct and the signal will show at the output of the circuit. If  $V_{IN}$  is in its negative half cycle then the output of the top amplifier will be positive, resulting in the diode on the output of the top amplifier conducting and delivering the signal from the amplifier's output to the circuit's output.

For  $R_2/R_1 \geq 2$ , the resistor values can be found by using the equation shown in [Figure 57](#). If  $R_2/R_1 = 1$ , then  $R_3$  should be left open, no resistor needed, and  $R_4$  should simply be shorted.



**Figure 57. Precision Rectifier**

---

## REVISION HISTORY

| Changes from Revision D (March 2013) to Revision E         | Page               |
|--|--------------------|
| • Changed layout of National Data Sheet to TI format ..... | <a href="#">18</a> |

---

**PACKAGING INFORMATION**

| Orderable Device | Status<br>(1) | Package Type | Package Drawing | Pins | Package Qty | Eco Plan<br>(2)         | Lead/Ball Finish<br>(6) | MSL Peak Temp<br>(3) | Op Temp (°C) | Device Marking<br>(4/5) | Samples                 |
|------------------|---------------|--------------|-----------------|------|-------------|-------------------------|-------------------------|----------------------|--------------|-------------------------|-------------------------|
| LMP7715MF/NOPB   | ACTIVE        | SOT-23       | DBV             | 5    | 1000        | Green (RoHS & no Sb/Br) | CU SN                   | Level-1-260C-UNLIM   | -40 to 125   | AV3A                    | <a href="#">Samples</a> |
| LMP7715MFE/NOPB  | ACTIVE        | SOT-23       | DBV             | 5    | 250         | Green (RoHS & no Sb/Br) | CU SN                   | Level-1-260C-UNLIM   | -40 to 125   | AV3A                    | <a href="#">Samples</a> |
| LMP7715MFX/NOPB  | ACTIVE        | SOT-23       | DBV             | 5    | 3000        | Green (RoHS & no Sb/Br) | CU SN                   | Level-1-260C-UNLIM   | -40 to 125   | AV3A                    | <a href="#">Samples</a> |
| LMP7716MM/NOPB   | ACTIVE        | VSSOP        | DGK             | 8    | 1000        | Green (RoHS & no Sb/Br) | CU SN                   | Level-1-260C-UNLIM   | -40 to 125   | AX3A                    | <a href="#">Samples</a> |
| LMP7716MME/NOPB  | ACTIVE        | VSSOP        | DGK             | 8    | 250         | Green (RoHS & no Sb/Br) | CU SN                   | Level-1-260C-UNLIM   | -40 to 125   | AX3A                    | <a href="#">Samples</a> |
| LMP7716MMX/NOPB  | ACTIVE        | VSSOP        | DGK             | 8    | 3500        | Green (RoHS & no Sb/Br) | CU SN                   | Level-1-260C-UNLIM   | -40 to 125   | AX3A                    | <a href="#">Samples</a> |
| LMP7716QMM/NOPB  | ACTIVE        | VSSOP        | DGK             | 8    | 1000        | Green (RoHS & no Sb/Br) | CU SN                   | Level-1-260C-UNLIM   | -40 to 125   | AR5A                    | <a href="#">Samples</a> |
| LMP7716QMME/NOPB | ACTIVE        | VSSOP        | DGK             | 8    | 250         | Green (RoHS & no Sb/Br) | CU SN                   | Level-1-260C-UNLIM   | -40 to 125   | AR5A                    | <a href="#">Samples</a> |
| LMP7716QMMX/NOPB | ACTIVE        | VSSOP        | DGK             | 8    | 3500        | Green (RoHS & no Sb/Br) | CU SN                   | Level-1-260C-UNLIM   | -40 to 125   | AR5A                    | <a href="#">Samples</a> |

(1) The marketing status values are defined as follows:

**ACTIVE:** Product device recommended for new designs.

**LIFEBUY:** TI has announced that the device will be discontinued, and a lifetime-buy period is in effect.

**NRND:** Not recommended for new designs. Device is in production to support existing customers, but TI does not recommend using this part in a new design.

**PREVIEW:** Device has been announced but is not in production. Samples may or may not be available.

**OBSOLETE:** TI has discontinued the production of the device.

(2) Eco Plan - The planned eco-friendly classification: Pb-Free (RoHS), Pb-Free (RoHS Exempt), or Green (RoHS & no Sb/Br) - please check <http://www.ti.com/productcontent> for the latest availability information and additional product content details.

**TBD:** The Pb-Free/Green conversion plan has not been defined.

**Pb-Free (RoHS):** TI's terms "Lead-Free" or "Pb-Free" mean semiconductor products that are compatible with the current RoHS requirements for all 6 substances, including the requirement that lead not exceed 0.1% by weight in homogeneous materials. Where designed to be soldered at high temperatures, TI Pb-Free products are suitable for use in specified lead-free processes.

**Pb-Free (RoHS Exempt):** This component has a RoHS exemption for either 1) lead-based flip-chip solder bumps used between the die and package, or 2) lead-based die adhesive used between the die and leadframe. The component is otherwise considered Pb-Free (RoHS compatible) as defined above.

**Green (RoHS & no Sb/Br):** TI defines "Green" to mean Pb-Free (RoHS compatible), and free of Bromine (Br) and Antimony (Sb) based flame retardants (Br or Sb do not exceed 0.1% by weight in homogeneous material)

- (3) MSL, Peak Temp. - The Moisture Sensitivity Level rating according to the JEDEC industry standard classifications, and peak solder temperature.
- (4) There may be additional marking, which relates to the logo, the lot trace code information, or the environmental category on the device.
- (5) Multiple Device Markings will be inside parentheses. Only one Device Marking contained in parentheses and separated by a "~" will appear on a device. If a line is indented then it is a continuation of the previous line and the two combined represent the entire Device Marking for that device.
- (6) Lead/Ball Finish - Orderable Devices may have multiple material finish options. Finish options are separated by a vertical ruled line. Lead/Ball Finish values may wrap to two lines if the finish value exceeds the maximum column width.

**Important Information and Disclaimer:**The information provided on this page represents TI's knowledge and belief as of the date that it is provided. TI bases its knowledge and belief on information provided by third parties, and makes no representation or warranty as to the accuracy of such information. Efforts are underway to better integrate information from third parties. TI has taken and continues to take reasonable steps to provide representative and accurate information but may not have conducted destructive testing or chemical analysis on incoming materials and chemicals. TI and TI suppliers consider certain information to be proprietary, and thus CAS numbers and other limited information may not be available for release.

In no event shall TI's liability arising out of such information exceed the total purchase price of the TI part(s) at issue in this document sold by TI to Customer on an annual basis.

**OTHER QUALIFIED VERSIONS OF LMP7716, LMP7716-Q1 :**

- Catalog: [LMP7716](#)
- Automotive: [LMP7716-Q1](#)

NOTE: Qualified Version Definitions:

- Catalog - TI's standard catalog product
- Automotive - Q100 devices qualified for high-reliability automotive applications targeting zero defects

## TAPE AND REEL INFORMATION

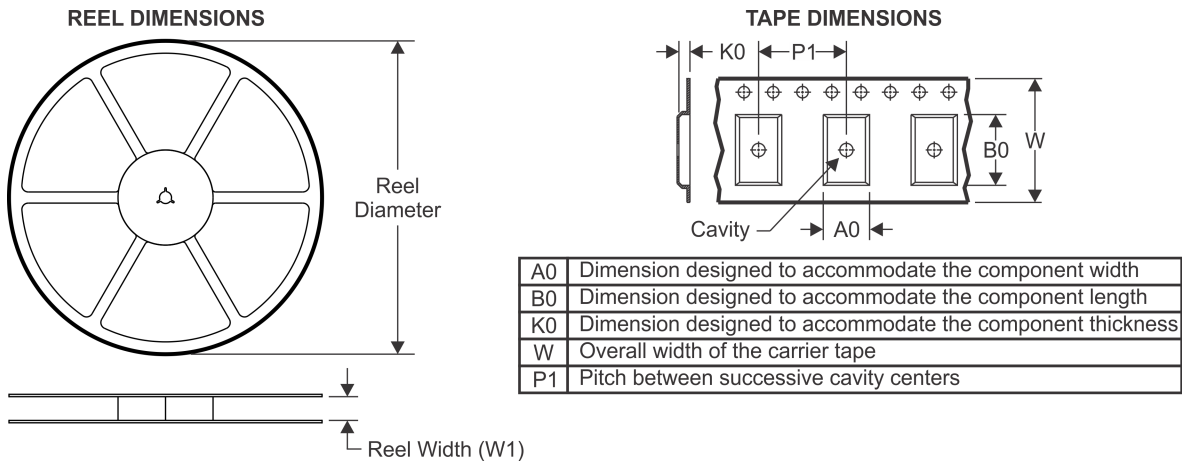

### QUADRANT ASSIGNMENTS FOR PIN 1 ORIENTATION IN TAPE



\*All dimensions are nominal

| Device           | Package Type | Package Drawing | Pins | SPQ  | Reel Diameter (mm) | Reel Width W1 (mm) | A0 (mm) | B0 (mm) | K0 (mm) | P1 (mm) | W (mm) | Pin1 Quadrant |
|------------------|--------------|-----------------|------|------|--------------------|--------------------|---------|---------|---------|---------|--------|---------------|
| LMP7715MF/NOPB   | SOT-23       | DBV             | 5    | 1000 | 178.0              | 8.4                | 3.2     | 3.2     | 1.4     | 4.0     | 8.0    | Q3            |
| LMP7715MFE/NOPB  | SOT-23       | DBV             | 5    | 250  | 178.0              | 8.4                | 3.2     | 3.2     | 1.4     | 4.0     | 8.0    | Q3            |
| LMP7715MFX/NOPB  | SOT-23       | DBV             | 5    | 3000 | 178.0              | 8.4                | 3.2     | 3.2     | 1.4     | 4.0     | 8.0    | Q3            |
| LMP7716MM/NOPB   | VSSOP        | DGK             | 8    | 1000 | 178.0              | 12.4               | 5.3     | 3.4     | 1.4     | 8.0     | 12.0   | Q1            |
| LMP7716MME/NOPB  | VSSOP        | DGK             | 8    | 250  | 178.0              | 12.4               | 5.3     | 3.4     | 1.4     | 8.0     | 12.0   | Q1            |
| LMP7716MMX/NOPB  | VSSOP        | DGK             | 8    | 3500 | 330.0              | 12.4               | 5.3     | 3.4     | 1.4     | 8.0     | 12.0   | Q1            |
| LMP7716QMM/NOPB  | VSSOP        | DGK             | 8    | 1000 | 178.0              | 12.4               | 5.3     | 3.4     | 1.4     | 8.0     | 12.0   | Q1            |
| LMP7716QMME/NOPB | VSSOP        | DGK             | 8    | 250  | 178.0              | 12.4               | 5.3     | 3.4     | 1.4     | 8.0     | 12.0   | Q1            |
| LMP7716QMMX/NOPB | VSSOP        | DGK             | 8    | 3500 | 330.0              | 12.4               | 5.3     | 3.4     | 1.4     | 8.0     | 12.0   | Q1            |

**TAPE AND REEL BOX DIMENSIONS**

\*All dimensions are nominal

| Device           | Package Type | Package Drawing | Pins | SPQ  | Length (mm) | Width (mm) | Height (mm) |
|------------------|--------------|-----------------|------|------|-------------|------------|-------------|
| LMP7715MF/NOPB   | SOT-23       | DBV             | 5    | 1000 | 210.0       | 185.0      | 35.0        |
| LMP7715MFE/NOPB  | SOT-23       | DBV             | 5    | 250  | 210.0       | 185.0      | 35.0        |
| LMP7715MFX/NOPB  | SOT-23       | DBV             | 5    | 3000 | 210.0       | 185.0      | 35.0        |
| LMP7716MM/NOPB   | VSSOP        | DGK             | 8    | 1000 | 210.0       | 185.0      | 35.0        |
| LMP7716MME/NOPB  | VSSOP        | DGK             | 8    | 250  | 210.0       | 185.0      | 35.0        |
| LMP7716MMX/NOPB  | VSSOP        | DGK             | 8    | 3500 | 367.0       | 367.0      | 35.0        |
| LMP7716QMM/NOPB  | VSSOP        | DGK             | 8    | 1000 | 210.0       | 185.0      | 35.0        |
| LMP7716QMME/NOPB | VSSOP        | DGK             | 8    | 250  | 210.0       | 185.0      | 35.0        |
| LMP7716QMMX/NOPB | VSSOP        | DGK             | 8    | 3500 | 367.0       | 367.0      | 35.0        |

DBV (R-PDSO-G5)

PLASTIC SMALL-OUTLINE PACKAGE

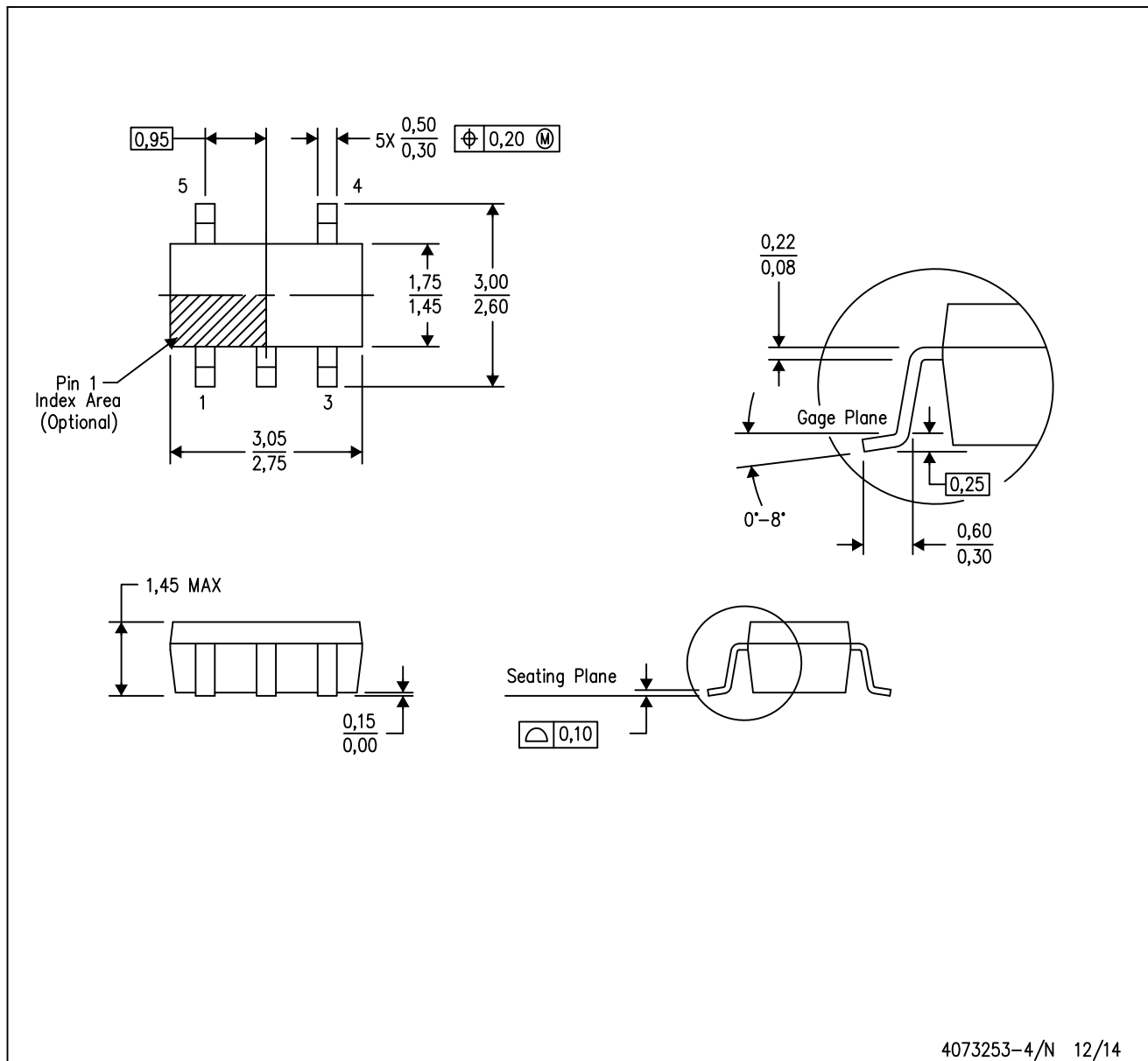

- NOTES:
- A. All linear dimensions are in millimeters.
  - B. This drawing is subject to change without notice.
  - C. Body dimensions do not include mold flash or protrusion. Mold flash and protrusion shall not exceed 0.15 per side.
  - D. Falls within JEDEC MO-178 Variation AA.



DBV (R-PDSO-G5)

PLASTIC SMALL OUTLINE

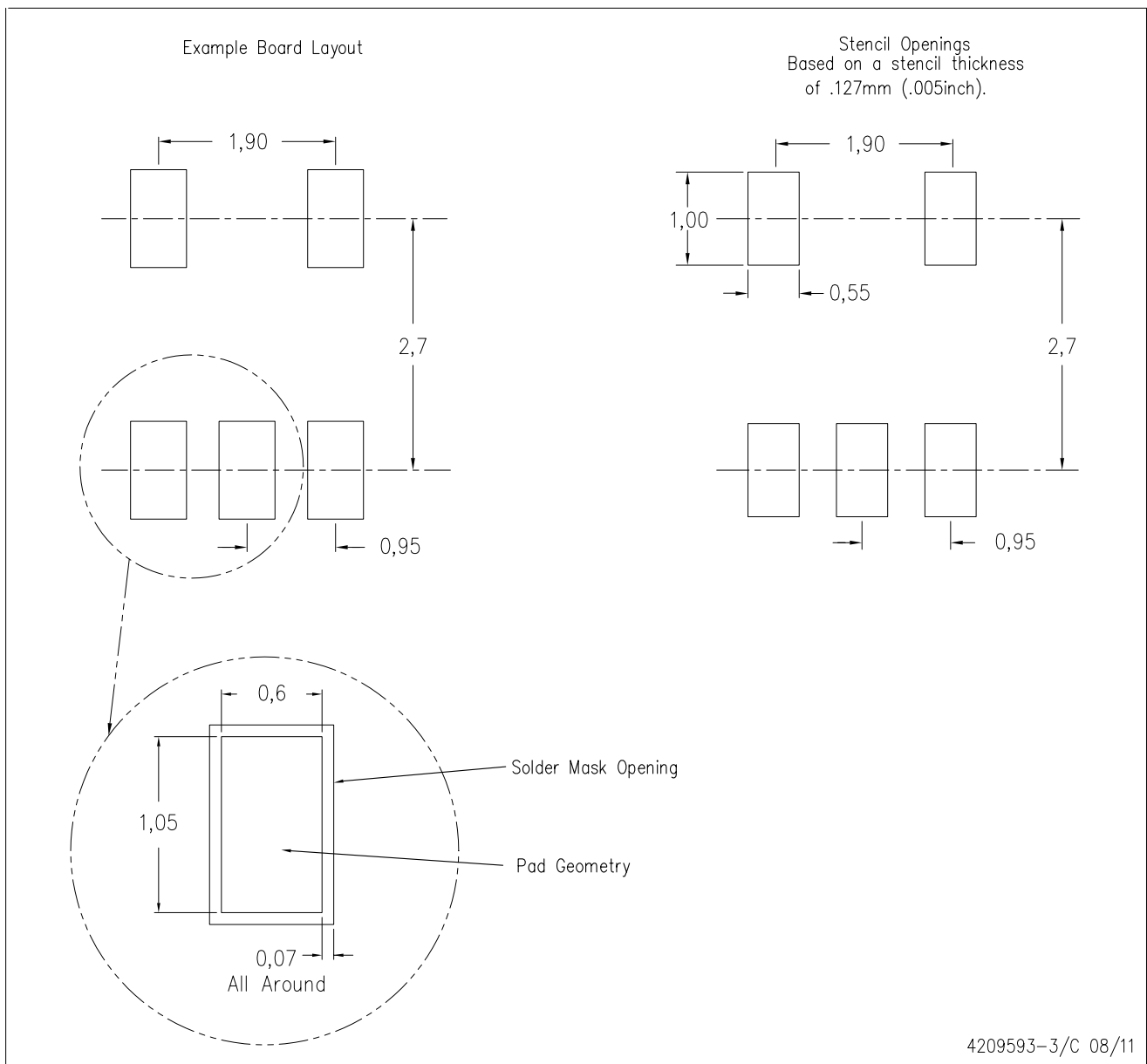

- NOTES:
- A. All linear dimensions are in millimeters.
  - B. This drawing is subject to change without notice.
  - C. Customers should place a note on the circuit board fabrication drawing not to alter the center solder mask defined pad.
  - D. Publication IPC-7351 is recommended for alternate designs.
  - E. Laser cutting apertures with trapezoidal walls and also rounding corners will offer better paste release. Customers should contact their board assembly site for stencil design recommendations. Example stencil design based on a 50% volumetric metal load solder paste. Refer to IPC-7525 for other stencil recommendations.

DGK (S-PDSO-G8)

PLASTIC SMALL-OUTLINE PACKAGE

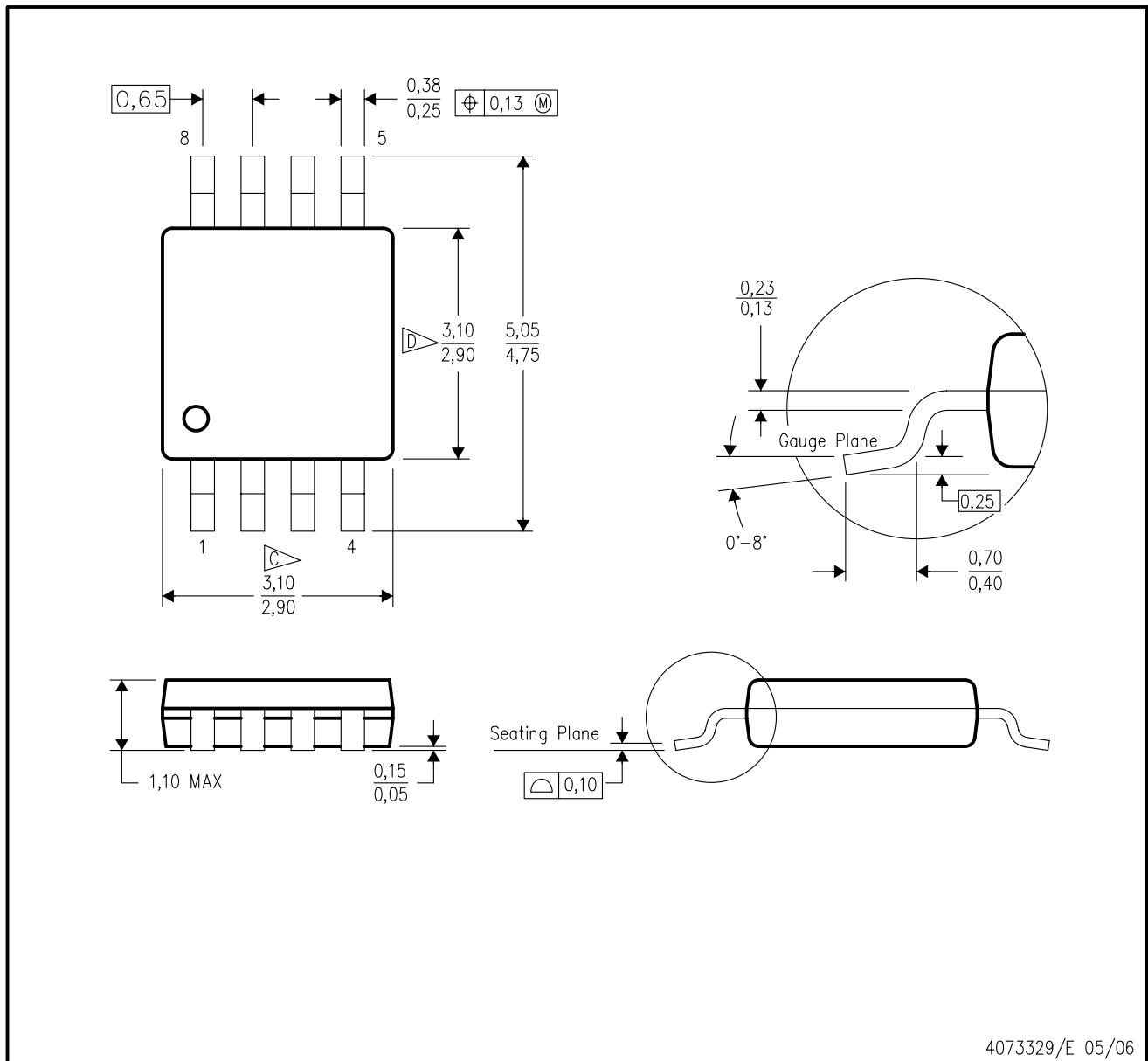

- NOTES:
- A. All linear dimensions are in millimeters.
  - B. This drawing is subject to change without notice.
  - C. Body length does not include mold flash, protrusions, or gate burrs. Mold flash, protrusions, or gate burrs shall not exceed 0.15 per end.
  - D. Body width does not include interlead flash. Interlead flash shall not exceed 0.50 per side.
  - E. Falls within JEDEC MO-187 variation AA, except interlead flash.

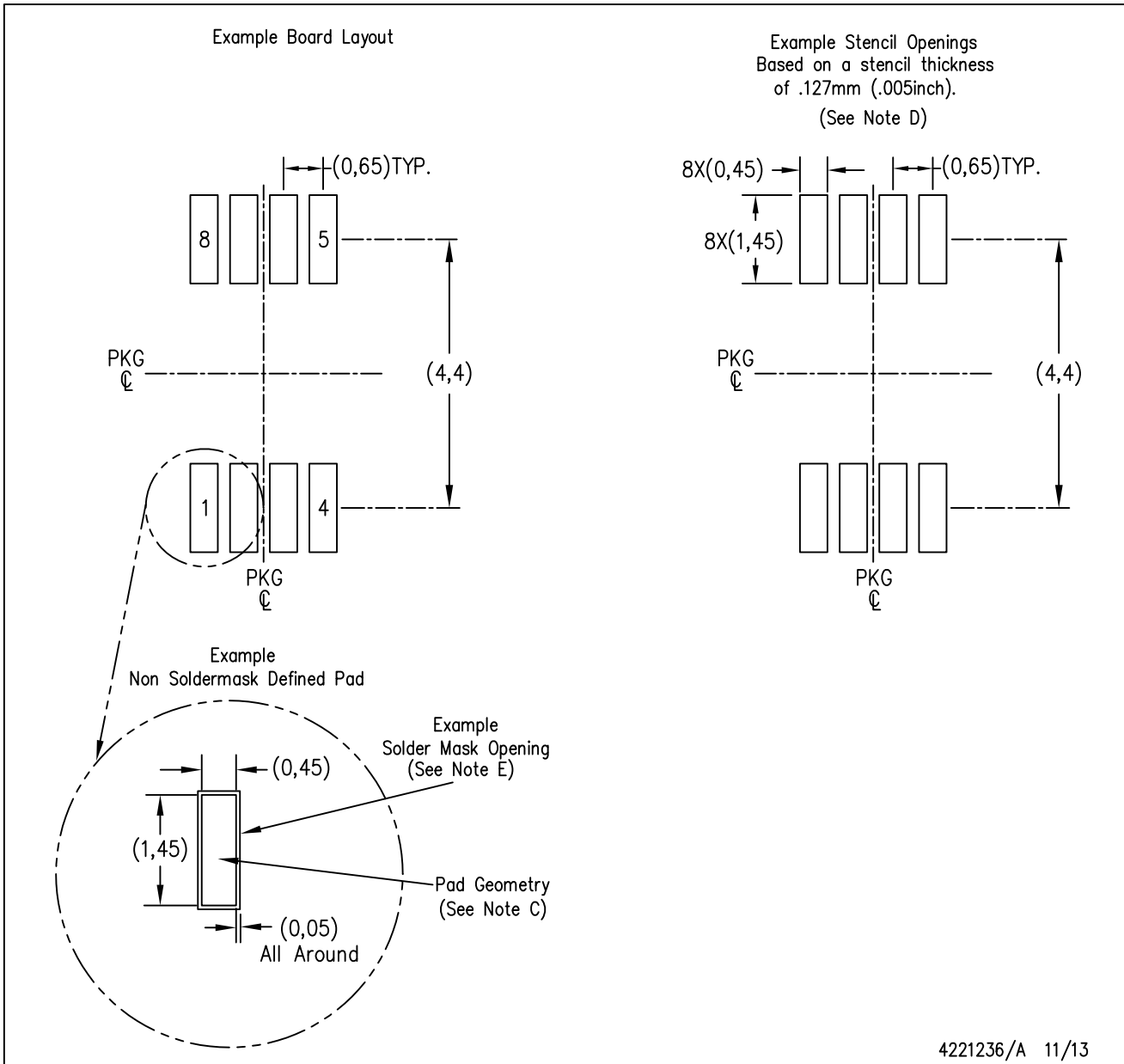

- NOTES:
- A. All linear dimensions are in millimeters.
  - B. This drawing is subject to change without notice.
  - C. Publication IPC-7351 is recommended for alternate designs.
  - D. Laser cutting apertures with trapezoidal walls and also rounding corners will offer better paste release. Customers should contact their board assembly site for stencil design recommendations. Refer to IPC-7525 for other stencil recommendations.
  - E. Customers should contact their board fabrication site for solder mask tolerances between and around signal pads.

## IMPORTANT NOTICE

Texas Instruments Incorporated and its subsidiaries (TI) reserve the right to make corrections, enhancements, improvements and other changes to its semiconductor products and services per JESD46, latest issue, and to discontinue any product or service per JESD48, latest issue. Buyers should obtain the latest relevant information before placing orders and should verify that such information is current and complete. All semiconductor products (also referred to herein as "components") are sold subject to TI's terms and conditions of sale supplied at the time of order acknowledgment.

TI warrants performance of its components to the specifications applicable at the time of sale, in accordance with the warranty in TI's terms and conditions of sale of semiconductor products. Testing and other quality control techniques are used to the extent TI deems necessary to support this warranty. Except where mandated by applicable law, testing of all parameters of each component is not necessarily performed.

TI assumes no liability for applications assistance or the design of Buyers' products. Buyers are responsible for their products and applications using TI components. To minimize the risks associated with Buyers' products and applications, Buyers should provide adequate design and operating safeguards.

TI does not warrant or represent that any license, either express or implied, is granted under any patent right, copyright, mask work right, or other intellectual property right relating to any combination, machine, or process in which TI components or services are used. Information published by TI regarding third-party products or services does not constitute a license to use such products or services or a warranty or endorsement thereof. Use of such information may require a license from a third party under the patents or other intellectual property of the third party, or a license from TI under the patents or other intellectual property of TI.

Reproduction of significant portions of TI information in TI data books or data sheets is permissible only if reproduction is without alteration and is accompanied by all associated warranties, conditions, limitations, and notices. TI is not responsible or liable for such altered documentation. Information of third parties may be subject to additional restrictions.

Resale of TI components or services with statements different from or beyond the parameters stated by TI for that component or service voids all express and any implied warranties for the associated TI component or service and is an unfair and deceptive business practice. TI is not responsible or liable for any such statements.

Buyer acknowledges and agrees that it is solely responsible for compliance with all legal, regulatory and safety-related requirements concerning its products, and any use of TI components in its applications, notwithstanding any applications-related information or support that may be provided by TI. Buyer represents and agrees that it has all the necessary expertise to create and implement safeguards which anticipate dangerous consequences of failures, monitor failures and their consequences, lessen the likelihood of failures that might cause harm and take appropriate remedial actions. Buyer will fully indemnify TI and its representatives against any damages arising out of the use of any TI components in safety-critical applications.

In some cases, TI components may be promoted specifically to facilitate safety-related applications. With such components, TI's goal is to help enable customers to design and create their own end-product solutions that meet applicable functional safety standards and requirements. Nonetheless, such components are subject to these terms.

No TI components are authorized for use in FDA Class III (or similar life-critical medical equipment) unless authorized officers of the parties have executed a special agreement specifically governing such use.

Only those TI components which TI has specifically designated as military grade or "enhanced plastic" are designed and intended for use in military/aerospace applications or environments. Buyer acknowledges and agrees that any military or aerospace use of TI components which have **not** been so designated is solely at the Buyer's risk, and that Buyer is solely responsible for compliance with all legal and regulatory requirements in connection with such use.

TI has specifically designated certain components as meeting ISO/TS16949 requirements, mainly for automotive use. In any case of use of non-designated products, TI will not be responsible for any failure to meet ISO/TS16949.

### Products

|                              |  |
|------------------------------|--|
| Audio                        | <a href="http://www.ti.com/audio">www.ti.com/audio</a>                               |
| Amplifiers                   | <a href="http://amplifier.ti.com">amplifier.ti.com</a>                               |
| Data Converters              | <a href="http://dataconverter.ti.com">dataconverter.ti.com</a>                       |
| DLP® Products                | <a href="http://www.dlp.com">www.dlp.com</a>   |
| DSP                          | <a href="http://dsp.ti.com">dsp.ti.com</a>   |
| Clocks and Timers            | <a href="http://www.ti.com/clocks">www.ti.com/clocks</a>                             |
| Interface                    | <a href="http://interface.ti.com">interface.ti.com</a>                               |
| Logic                        | <a href="http://logic.ti.com">logic.ti.com</a>                                       |
| Power Mgmt                   | <a href="http://power.ti.com">power.ti.com</a>                                       |
| Microcontrollers             | <a href="http://microcontroller.ti.com">microcontroller.ti.com</a>                   |
| RFID                         | <a href="http://www.ti-rfid.com">www.ti-rfid.com</a>                                 |
| OMAP Applications Processors | <a href="http://www.ti.com/omap">www.ti.com/omap</a>                                 |
| Wireless Connectivity        | <a href="http://www.ti.com/wirelessconnectivity">www.ti.com/wirelessconnectivity</a> |

### Applications

|                               |  |
|-------------------------------|--|
| Automotive and Transportation | <a href="http://www.ti.com/automotive">www.ti.com/automotive</a>                         |
| Communications and Telecom    | <a href="http://www.ti.com/communications">www.ti.com/communications</a>                 |
| Computers and Peripherals     | <a href="http://www.ti.com/computers">www.ti.com/computers</a>                           |
| Consumer Electronics          | <a href="http://www.ti.com/consumer-apps">www.ti.com/consumer-apps</a>                   |
| Energy and Lighting           | <a href="http://www.ti.com/energy">www.ti.com/energy</a>                                 |
| Industrial                    | <a href="http://www.ti.com/industrial">www.ti.com/industrial</a>                         |
| Medical                       | <a href="http://www.ti.com/medical">www.ti.com/medical</a>                               |
| Security                      | <a href="http://www.ti.com/security">www.ti.com/security</a>                             |
| Space, Avionics and Defense   | <a href="http://www.ti.com/space-avionics-defense">www.ti.com/space-avionics-defense</a> |
| Video and Imaging             | <a href="http://www.ti.com/video">www.ti.com/video</a>                                   |

### TI E2E Community

[e2e.ti.com](http://e2e.ti.com)