

## TPS6274x 针对低功耗应用的 360nA I<sub>Q</sub> 降压转换器

### 1 特性

- 输入电压 (V<sub>IN</sub>) 范围: 2.2V 至 5.5V
- 典型值 360nA 静态电流
- 10μA 输出电流时的效率高达 90%
- 高达 300mA/400mA 的输出电流 (TPS62740/TPS62742)
- 射频 (RF) 友好型 DCS-Control™
- 高达 2MHz 的开关频率
- 低输出纹波电压
- 1.8V 至 3.3V 之间 16 个可选输出电压 (步长 100mV)
- 自动转换至无纹波 100% 模式
- 转换率受控的负载开关
- V<sub>OUT</sub> / LOAD 上的放电功能
- 电源正常输出
- 针对与微型 2.2μH 电感器和 10μF C<sub>OUT</sub> 的共同运行进行了优化
- 总体解决方案尺寸 < 31mm<sup>2</sup>
- 小型 2mm x 3mm<sup>2</sup> 晶圆级小外形无引线 (WSON) 封装

### 2 应用范围

- Bluetooth® 低功耗 (Low Energy), 消费类电子产品用射频 (RF4CE), 短距离低功耗通信技术 (Zigbee)
- 工业用仪表计量
- 能量采集

### 4 典型应用

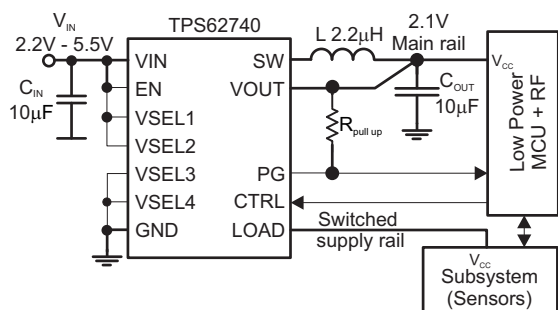

### 3 说明

TPS6274x 是业界第一款降压转换器, 此转换器特有典型值为 360nA 的静态电流, 并且搭配微型 2.2μH 电感和 10μF 输出电容一起工作。这款基于 DCS-Control™ 的全新器件将轻负载效率范围扩展至 10μA 负载电流以下。TPS62740 支持高达 300mA 的输出电流, TPS62742 支持高达 400mA 的输出电流。此器件由可再充电锂离子电池, 锂化学电池 (例如锂亚硫酰氟 (Li-SOCl<sub>2</sub>), 锂锰电池 (Li-MnO<sub>2</sub>) 和两节或三节碱性电池) 供电运行。输入电压范围高达 5.5V, 也实现由 1 个 USB 端口和薄膜太阳能模块供电运行。用户可使用 4 个 VSEL 引脚在 1.8V 至 3.3V 范围内选择输出电压 (步长 100mV)。TPS6274x 搭配使用小型输出电容, 特有低输出纹波电压和低噪声。一旦电池电压接近输出电压 (接近 100% 占空比), 此器件进入无纹波 100% 模式运行, 以防止输出纹波电压的增加。然后, 此器件停止开关, 并且输出被连接至输入电压。集成转换率受控负载开关特有典型值为 0.6Ω 的导通电阻, 并且将选择的输出电压分配至临时使用的子系统。TPS6274 采用小型 12 引脚 2mm x 3mm<sup>2</sup> WSON 封装, 并且支持 31mm<sup>2</sup> 的总体解决方案尺寸。

器件信息(1)

器件型号	封装	封装尺寸 (标称值)
TPS62740	WSON	3.00mm x 2.00mm
TPS62742		

(1) 要了解所有可用封装, 请见数据表末尾的可订购产品附录。

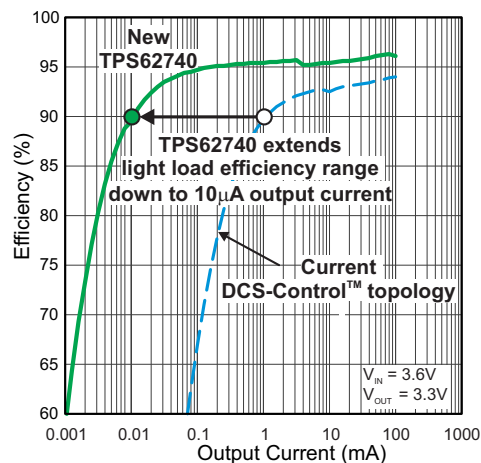

## 目录

<b>1</b>	特性 .....	<b>1</b>	9.3	Feature Description.....	<b>8</b>
<b>2</b>	应用范围.....	<b>1</b>	9.4	Device Functional Modes.....	<b>10</b>
<b>3</b>	说明 .....	<b>1</b>	<b>10</b>	<b>Application and Implementation.....</b>	<b>12</b>
<b>4</b>	典型应用.....	<b>1</b>	10.1	Application Information.....	<b>12</b>
<b>5</b>	修订历史记录 .....	<b>2</b>	10.2	Typical Application .....	<b>12</b>
<b>6</b>	<b>Device Comparison Table.....</b>	<b>3</b>	10.3	System Example .....	<b>22</b>
<b>7</b>	<b>Pin Configuration and Functions .....</b>	<b>3</b>	<b>11</b>	<b>Power Supply Recommendations .....</b>	<b>23</b>
<b>8</b>	<b>Specifications.....</b>	<b>4</b>	<b>12</b>	<b>Layout.....</b>	<b>23</b>
8.1	Absolute Maximum Ratings .....	<b>4</b>	12.1	Layout Guidelines .....	<b>23</b>
8.2	Handling Ratings .....	<b>4</b>	12.2	Layout Example .....	<b>23</b>
8.3	Recommended Operating Conditions.....	<b>5</b>	<b>13</b>	器件和文档支持 .....	<b>24</b>
8.4	Thermal Information .....	<b>5</b>	13.1	器件支持 .....	<b>24</b>
8.5	Electrical Characteristics.....	<b>5</b>	13.2	文档支持 .....	<b>24</b>
8.6	Typical Characteristics.....	<b>7</b>	13.3	相关链接 .....	<b>24</b>
<b>9</b>	<b>Detailed Description .....</b>	<b>8</b>	13.4	商标 .....	<b>24</b>
9.1	Overview .....	<b>8</b>	13.5	静电放电警告.....	<b>24</b>
9.2	Functional Block Diagram .....	<b>8</b>	13.6	术语表 .....	<b>24</b>
			<b>14</b>	机械封装和可订购信息 .....	<b>24</b>

## 5 修订历史记录

NOTE: Page numbers for previous revisions may differ from page numbers in the current version.

<b>Changes from Revision A (November 2013) to Revision B</b>		<b>Page</b>
•	已添加 TPS62742 器件.....	<b>1</b>
•	Added efficiency graph, <a href="#">Figure 11</a> .....	<b>15</b>

## 6 Device Comparison Table

T <sub>A</sub>	PART NUMBER	OUTPUT VOLTAGE SETTING VSEL 1 - 4	OUTPUT CURRENT [mA]	PACKAGE MARKING
-40°C to 85°C	TPS62740	1.8V to 3.3V in 100mV steps	300mA	62740
	TPS62741 <sup>(1)</sup>	1.3V to 2.8V in 100mV steps	300mA	-/-
	TPS62742	1.8V to 3.3V in 100mV steps	400mA	62742

(1) Device option, contact TI for more details

## 7 Pin Configuration and Functions

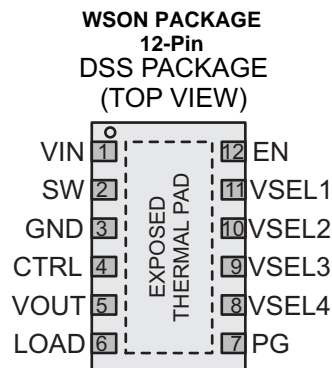

### Pin Functions

PIN		I/O	DESCRIPTION
NAME	NO		
VIN	1	PWR	V <sub>IN</sub> power supply pin. Connect this pin close to the VIN terminal of the input capacitor. A ceramic capacitor of 4.7μF is required.
SW	2	OUT	This is the switch pin and is connected to the internal MOSFET switches. Connect the inductor to this terminal.
GND	3	PWR	GND supply pin. Connect this pin close to the GND terminal of the input and output capacitor.
CTRL	4	IN	This pin controls the output LOAD pin. With CTRL = low, the output LOAD is disabled. This pin must be terminated.
VOUT	5	IN	Feedback pin for the internal feedback divider network and regulation loop. An internal load switch is connected between this pin and the LOAD pin. Connect this pin directly to the output capacitor with a short trace.
LOAD	6	OUT	This output is controlled by the CTRL Pin. With CTRL high, an internal load switch connects the LOAD pin to the VOUT pin. The LOAD pin allows to connect / disconnect other system components to the output of the DC/DC converter. This pin is pulled to GND with CTRL pin = low. The LOAD pin features a soft switching. If not used, leave the pin open.
PG	7	OUT	Power good open drain output. This pin is high impedance to indicate "Power Good". Connect a external pull up resistor to generate a "high" level. If not used, this pin can be left open.
VSEL4	8	IN	Output voltage selection pins. See <a href="#">Table 1</a> for V <sub>OUT</sub> selection. These pins must be terminated and can be changed during operation.
VSEL3	9	IN	
VSEL2	10	IN	
VSEL1	11	IN	
EN	12	IN	High level enables the devices, low level turns the device into shutdown mode. This pin must be terminated.
EXPOSED THERMAL PAD		NC	Not electrically connected to the IC, but must be soldered. Connect this pad to GND and use it as a central GND plane.

**Table 1. Output Voltage Setting**

Device	VOUT	VSEL 4	VSEL 3	VSEL 2	VSEL 1
TPS62740 / 42	1.8	0	0	0	0
	1.9	0	0	0	1
	2.0	0	0	1	0
	2.1	0	0	1	1
	2.2	0	1	0	0
	2.3	0	1	0	1
	2.4	0	1	1	0
	2.5	0	1	1	1
	2.6	1	0	0	0
	2.7	1	0	0	1
	2.8	1	0	1	0
	2.9	1	0	1	1
	3.0	1	1	0	0
	3.1	1	1	0	1
3.2	1	1	1	0	
3.3	1	1	1	1	

## 8 Specifications

### 8.1 Absolute Maximum Ratings<sup>(1)</sup>

Over operating free-air temperature range (unless otherwise noted)

		MIN	MAX	UNIT
Pin voltage <sup>(2)</sup>	V <sub>IN</sub>	-0.3	6	V
	SW <sup>(3)</sup>	-0.3	V <sub>IN</sub> +0.3V	V
	EN, CTRL, VSEL1-4	-0.3	V <sub>IN</sub> +0.3V	V
	PG	-0.3	V <sub>IN</sub> +0.3V	V
	VOUT, LOAD	-0.3	3.7	V
PG pin	I <sub>PG</sub>		10	mA
Maximum operating junction temperature, T <sub>J</sub>		-40	150	°C

(1) Stresses beyond those listed under *absolute maximum ratings* may cause permanent damage to the device. These are stress ratings only and functional operation of the device at these or any other conditions beyond those indicated under *recommended operating conditions* is not implied. Exposure to absolute–maximum–rated conditions for extended periods may affect device reliability.

(2) All voltage values are with respect to network ground terminal GND.

(3) The MAX value V<sub>IN</sub> +0.3V applies for applicative operation (device switching), DC voltage applied to this pin may not exceed 4V

### 8.2 Handling Ratings

		MIN	MAX	UNIT
T <sub>stg</sub>	Storage temperature range	-65	150	°C
V <sub>(ESD)</sub>	Electrostatic discharge	Human body model (HBM), per ANSI/ESDA/JEDEC JS-001, all pins <sup>(1)</sup>	2000	V
		Charged device model (CDM), per JEDEC specification JESD22-C101, all pins <sup>(2)</sup>	1000	

(1) JEDEC document JEP155 states that 500-V HBM allows safe manufacturing with a standard ESD control process. The human body model is a 100-pF capacitor discharged through a 1.5-kΩ resistor into each pin.

(2) JEDEC document JEP157 states that 250-V CDM allows safe manufacturing with a standard ESD control process.

### 8.3 Recommended Operating Conditions

		MIN	NOM	MAX	UNIT
$V_{IN}$	Supply voltage $V_{IN}^{(1)}$	2.2		5.5	V
$I_{OUT} + I_{LOAD}$	Device output current (sum of $I_{OUT}$ and $I_{LOAD}$ )	$V_{OUTnom} + 0.7V \leq V_{IN} \leq 5.5V$	TPS62740	300	mA
		$3V \leq V_{IN}, V_{OUTnom} + 0.7V \leq V_{IN} \leq 5.5V$	TPS62742	400	
		$V_{OUTnom} \leq V_{IN} \leq V_{OUTnom} + 0.7V$		100	
$I_{LOAD}$	Load current (current from LOAD pin)			100	
L	Inductance	1.5	2.2	3.3	$\mu$ H
$C_{OUT}$	Output capacitance connected to VOUT pin (not including LOAD pin)			22	$\mu$ F
$C_{LOAD}$	Capacitance connected to LOAD pin			10	
$T_J$	Operating junction temperature range	-40		125	$^{\circ}$ C
$T_A$	Ambient temperature range	-40		85	

(1) The minimum required supply voltage for startup is 2.15V (undervoltage lockout threshold  $V_{TH\_UVLO+}$ ). The device is functional down to 2V supply voltage (falling undervoltage lockout threshold  $V_{TH\_UVLO-}$ ).

### 8.4 Thermal Information

THERMAL METRIC		DSS / 12 PINS	UNIT
$R_{\theta JA}$	Junction-to-ambient thermal resistance	61.8	$^{\circ}$ C/W
$R_{\theta Jctop}$	Junction-to-case (top) thermal resistance	70.9	
$R_{\theta JB}$	Junction-to-board thermal resistance	25.7	
$\psi_{JT}$	Junction-to-top characterization parameter	1.9	
$\psi_{JB}$	Junction-to-board characterization parameter	25.7	
$R_{\theta Jcbot}$	Junction-to-case (bottom) thermal resistance	7.2	

### 8.5 Electrical Characteristics

$V_{IN} = 3.6V$ ,  $T_A = -40^{\circ}C$  to  $85^{\circ}C$  typical values are at  $T_A = 25^{\circ}C$  (unless otherwise noted)

PARAMETER		TEST CONDITIONS	MIN	TYP	MAX	UNIT
<b>SUPPLY</b>						
$V_{IN}$	Input voltage range		2.2		5.5	V
$I_Q$	Operating quiescent current	$EN = V_{IN}, CTRL = GND, I_{OUT} = 0\mu A, V_{OUT} = 1.8V$ , device not switching,		360	1800	nA
		$EN = V_{IN}, I_{OUT} = 0mA, CTRL = GND, V_{OUT} = 1.8V$ , device switching		460		
		$EN = V_{IN}, I_{OUT} = 0mA, CTRL = V_{IN}, V_{OUT} = 1.8V$ , device not switching		12.5		$\mu$ A
$I_{SD}$	Shutdown current	$EN = GND$ , shutdown current into $V_{IN}$		70	1000	nA
		$EN = GND$ , shutdown current into $V_{IN}, T_A = 60^{\circ}C$		150	450	
$V_{TH\_UVLO+}$	Undervoltage lockout threshold	Rising $V_{IN}$		2.075	2.15	V
$V_{TH\_UVLO-}$		Falling $V_{IN}$		1.925	2	
<b>INPUTS EN, CTRL, VSEL 1-4</b>						
$V_{IH\ TH}$	High level input threshold	$2.2V \leq V_{IN} \leq 5.5V$			1.1	V
$V_{IL\ TH}$	Low level input threshold	$2.2V \leq V_{IN} \leq 5.5V$		0.4		V
$I_{IN}$	Input bias Current	$T_A = 25^{\circ}C$			10	nA
		$T_A = -40^{\circ}C$ to $85^{\circ}C$			25	
<b>POWER SWITCHES</b>						
$R_{DS(ON)}$	High side MOSFET on-resistance	$V_{IN} = 3.6V, I_{OUT} = 50mA$		0.6	0.85	$\Omega$
	Low Side MOSFET on-resistance			0.36	0.5	

**Electrical Characteristics (continued)**
 $V_{IN} = 3.6V$ ,  $T_A = -40^{\circ}C$  to  $85^{\circ}C$  typical values are at  $T_A = 25^{\circ}C$  (unless otherwise noted)

PARAMETER		TEST CONDITIONS	MIN	TYP	MAX	UNIT	
$I_{LIMF}$	High side MOSFET switch current limit	$2.2V \leq V_{IN} \leq 5.5V$ , TPS62740	480	600	720	mA	
		$3.0V \leq V_{IN} \leq 5.5V$ , TPS62742	590	650	740		
	Low side MOSFET switch current limit	TPS62740		600		mA	
		TPS62742		650			
<b>OUTPUT DISCHARGE SWITCH (VOUT)</b>							
$R_{DSCH\_VOUT}$	MOSFET on-resistance	$V_{IN} = 3.6V$ , EN = GND, $I_{OUT} = -10mA$ into VOUT pin		30	65	$\Omega$	
$I_{IN\_VOUT}$	Bias current into VOUT pin	$V_{IN} = 3.6V$ , EN = $V_{IN}$ , VOUT = 2V, CTRL = GND	$T_A = 25^{\circ}C$	40	100	nA	
			$T_A = -40^{\circ}C$ to $85^{\circ}C$		1010		
<b>LOAD OUTPUT (LOAD)</b>							
$R_{LOAD}$	High side MOSFET on-resistance	$I_{LOAD} = 50mA$ , CTRL = $V_{IN}$ , VOUT = 2.0V, $2.2V \leq V_{IN} \leq 5.5V$		0.6	1.25	$\Omega$	
$R_{DSCH\_LOAD}$	Low side MOSFET on-resistance	CTRL = GND, $2.2V \leq V_{IN} \leq 5.5V$ , $I_{LOAD} = -10mA$		30	65		
$t_{Rise\_LOAD}$	$V_{LOAD}$ rise time	Starting with CTRL low to high transition, time to ramp $V_{LOAD}$ from 0V to 95% VOUT = 1.8V, $2.2V \leq V_{IN} \leq 5.5V$ , $I_{LOAD} = 1mA$		315	800	$\mu s$	
<b>AUTO 100% MODE TRANSITION</b>							
$V_{TH\_100+}$	Auto 100% Mode leave detection threshold <sup>(1)</sup>	Rising $V_{IN}$ , 100% Mode is left with $V_{IN} = V_{OUT} + V_{TH\_100+}$ , max value at $T_J = 85^{\circ}C$	170	250	340	mV	
$V_{TH\_100-}$	Auto 100% Mode enter detection threshold <sup>(1)</sup>	Falling $V_{IN}$ , 100% Mode is entered with $V_{IN} = V_{OUT} + V_{TH\_100-}$ , max value at $T_J = 85^{\circ}C$	110	200	280		
<b>POWER GOOD OUTPUT (PG, OPEN DRAIN)</b>							
$V_{TH\_PG+}$	Power good threshold voltage	Rising output voltage on VOUT pin, referred to $V_{VOUT}$		97.5%			
$V_{PG\_Hys}$		Hysteresis			-3%		
$V_{OL}$	Low level output voltage	$2.2V \leq V_{IN} \leq 5.5V$ , EN = GND, current into PG pin $I_{PG} = 4mA$			0.3	V	
$I_{IN\_PG}$	Bias current into PG pin	PG pin is high impedance, VOUT = 2V, EN = $V_{IN}$ , CTRL = GND, $I_{OUT} = 0mA$	$T_A = 25^{\circ}C$	0	10	nA	
			$T_A = -40^{\circ}C$ to $85^{\circ}C$		25		
<b>OUTPUT</b>							
$t_{ONmin}$	Minimum ON time	$V_{IN} = 3.6V$ , $V_{OUT} = 2.0V$ , $I_{OUT} = 0mA$		225		ns	
$t_{OFFmin}$	Minimum OFF time	$V_{IN} = 2.3V$		50		ns	
$t_{Startup\_delay}$	Regulator start up delay time	$V_{IN} = 3.6V$ , from transition EN = low to high until device starts switching		10	25	ms	
$t_{Softstart}$	Softstart time with reduced switch current limit	$2.2V \leq V_{IN} \leq 5.5V$ , EN = $V_{IN}$		700	1200	$\mu s$	
$I_{LIM\_softstart}$	High side MOSFET switch current limit	Reduced switch current limit during softstart	TPS62740	80	150	200	mA
			TPS62742		150		
	Low side MOSFET switch current limit			150			
$V_{VOUT}$	Output voltage range	Output voltages are selected with pins VSEL 1 - 4		1.8	3.3	V	
	Output voltage accuracy	$V_{IN} = 3.6V$ , $I_{OUT} = 10mA$ , $V_{OUT} = 1.8V$	-2.5	0%	2.5		
		$V_{IN} = 3.6V$ , $I_{OUT} = 100mA$ , $V_{OUT} = 1.8V$	-2	0%	2		
	DC output voltage load regulation	$V_{OUT} = 1.8V$ , $V_{IN} = 3.6V$ , CTRL = $V_{IN}$		0.001		%/mA	
DC output voltage line regulation	$V_{OUT} = 1.8V$ , CTRL = $V_{IN}$ , $I_{OUT} = 10mA$ , $2.5V \leq V_{IN} \leq 5.5V$		0		%/V		

(1)  $V_{IN}$  is compared to the programmed output voltage ( $V_{OUT}$ ). When  $V_{IN} - V_{OUT}$  falls below  $V_{TH\_100-}$ , the device enters 100% Mode by turning the high side MOSFET on. The 100% Mode is exited when  $V_{IN} - V_{OUT}$  exceeds  $V_{TH\_100+}$  and the device starts switching. The hysteresis for the 100% Mode detection threshold  $V_{TH\_100+} - V_{TH\_100-}$  will always be positive and will be approximately 50 mV(typ.)

## 8.6 Typical Characteristics

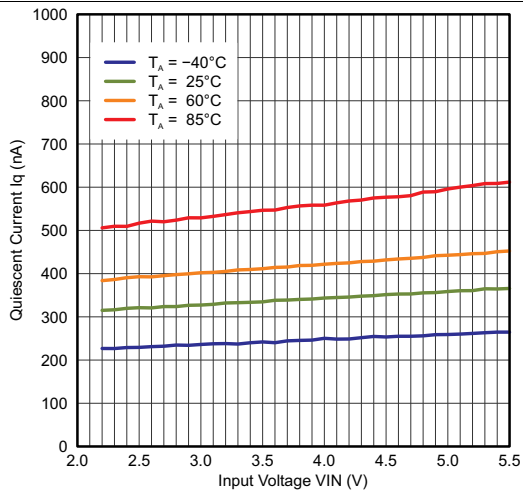

EN = VIN, V<sub>OUT</sub> = 1.8V, CTRL = GND Device Not Switching

Figure 1. Quiescent Current

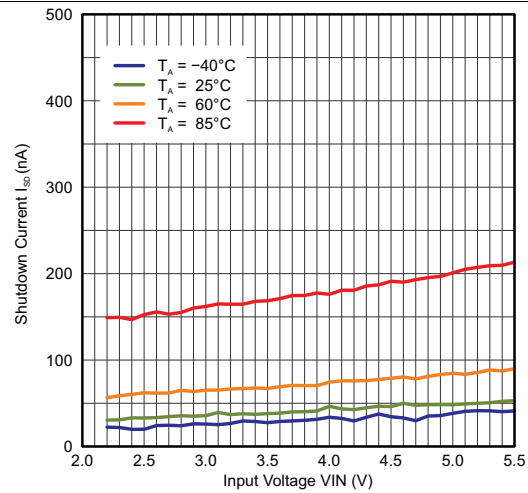

EN = GND

Figure 2. Shutdown Current I<sub>SD</sub>

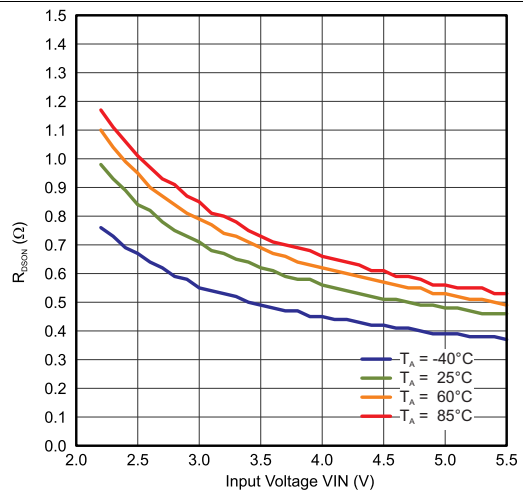

Figure 3. R<sub>DSON</sub> High Side Mosfet

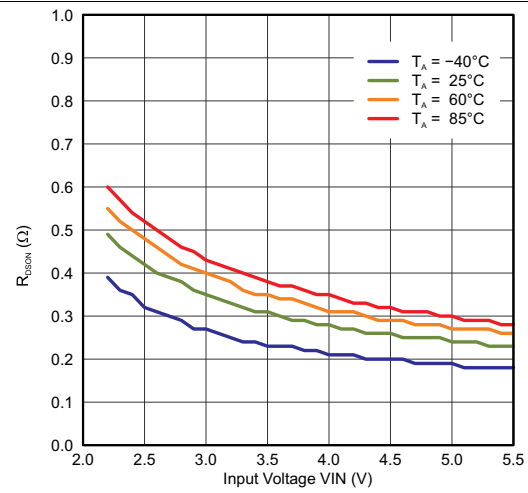

Figure 4. R<sub>DSON</sub> Low Side Mosfet

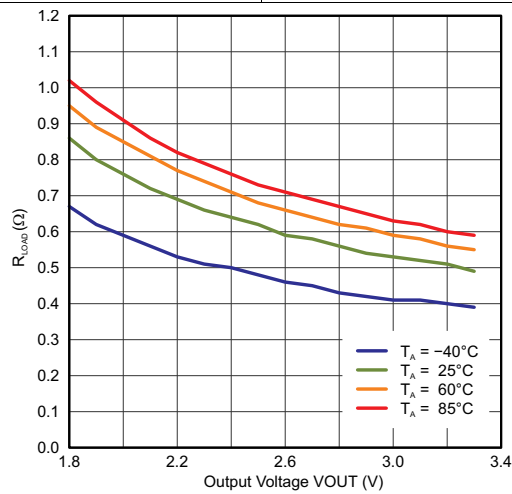

Figure 5. Load Switch Resistance R<sub>LOAD</sub>

## 9 Detailed Description

### 9.1 Overview

The TPS6274x is the first step down converter with an ultra low quiescent current consumption (360nA typ.) and featuring TI's DCS-Control™ topology while maintaining a regulated output voltage. The device extends high efficiency operation to output currents down to a few micro amperes.

### 9.2 Functional Block Diagram

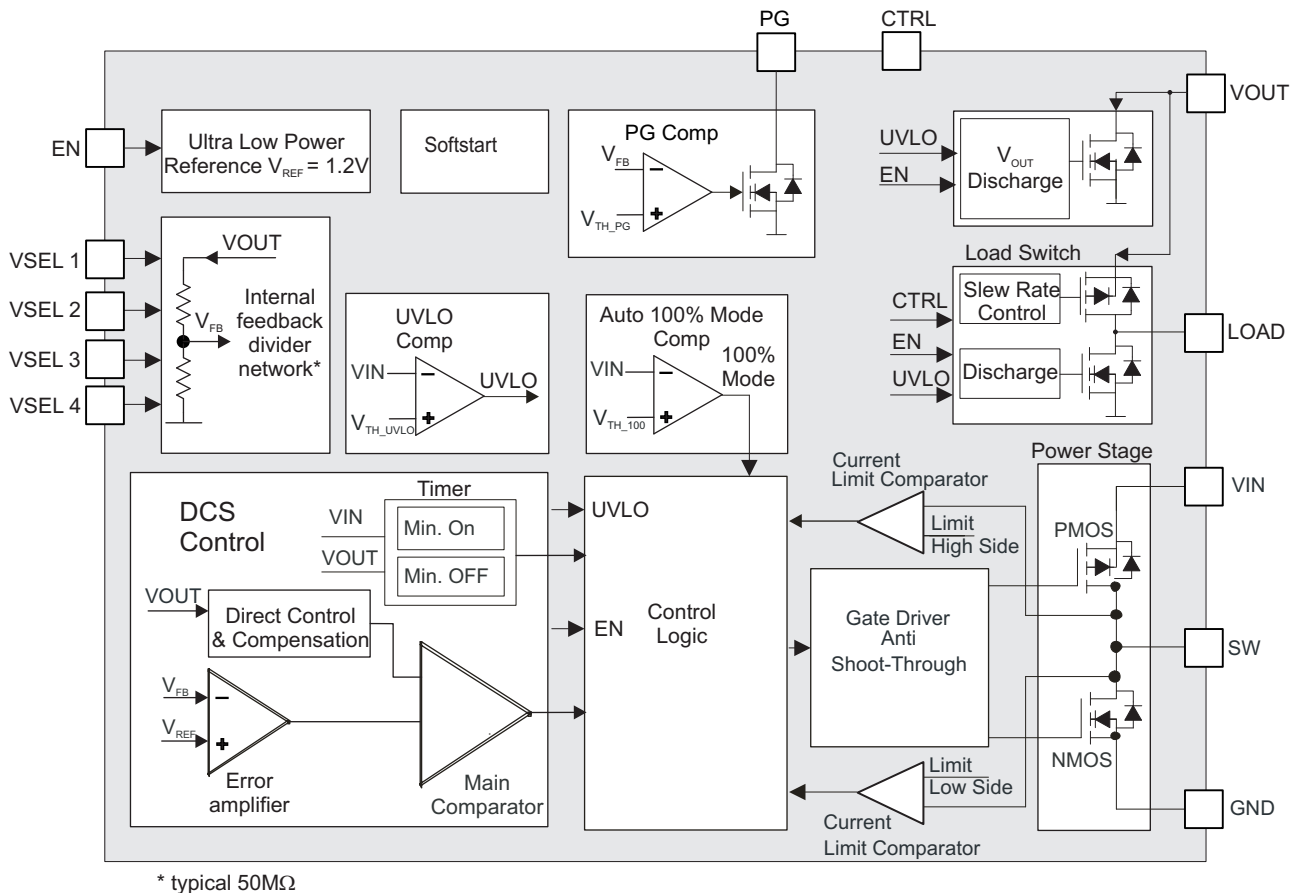

### 9.3 Feature Description

#### 9.3.1 DCS-Control™

TI's DCS-Control™ (Direct Control with Seamless Transition into Power Save Mode) is an advanced regulation topology, which combines the advantages of hysteretic and voltage mode control. Characteristics of DCS-Control™ are excellent AC load regulation and transient response, low output ripple voltage and a seamless transition between PFM and PWM mode operation. DCS-Control™ includes an AC loop which senses the output voltage (VOUT pin) and directly feeds the information to a fast comparator stage. This comparator sets the switching frequency, which is constant for steady state operating conditions, and provides immediate response to dynamic load changes. In order to achieve accurate DC load regulation, a voltage feedback loop is used. The internally compensated regulation network achieves fast and stable operation with small external components and low ESR capacitors.



## Feature Description (continued)

The DCS-Control™ topology supports PWM (Pulse Width Modulation) mode for medium and high load conditions and a Power Save Mode at light loads. During PWM mode, it operates in continuous conduction. The switching frequency is up to 2MHz with a controlled frequency variation depending on the input voltage. If the load current decreases, the converter seamlessly enters Power Save Mode to maintain high efficiency down to very light loads. In Power Save Mode the switching frequency varies nearly linearly with the load current. Since DCS-Control™ supports both operation modes within one single building block, the transition from PWM to Power Save Mode is seamless without effects on the output voltage. The TPS6274x offers both excellent DC voltage and superior load transient regulation, combined with very low output voltage ripple, minimizing interference with RF circuits. At high load currents, the converter operates in quasi fixed frequency PWM mode operation and at light loads, in PFM (Pulse Frequency Modulation) mode to maintain highest efficiency over the full load current range. In PFM Mode, the device generates a single switching pulse to ramp up the inductor current and recharge the output capacitor, followed by a sleep period where most of the internal circuits are shutdown to achieve a lowest quiescent current. During this time, the load current is supported by the output capacitor. The duration of the sleep period depends on the load current and the inductor peak current.

During the sleep periods, the current consumption of TPS6274x is reduced to 360nA. This low quiescent current consumption is achieved by an ultra low power voltage reference, an integrated high impedance (typ. 50MΩ) feedback divider network and an optimized DCS-Control™ block.

### 9.3.2 CTRL / Output Load

With the CTRL pin set to high, the LOAD pin is connected to the VOUT pin via an load switch and can power up an additional, temporarily used sub-system. The load switch is slew rate controlled to support soft switching and not to impact the regulated output VOUT. If CTRL pin is pulled to GND, the LOAD pin is disconnected from the VOUT pin and internally connected to GND by an internal discharge switch. When CTRL pin is set to high, the Quiescent current of the DCS control block is increased to typ. 12.5μA. This ensures excellent transient response on both outputs VOUT and LOAD in case of a sudden load step at the LOAD output. The CTRL pin can be controlled by a micro controller.

### 9.3.3 Enable / Shutdown

The DC/DC converter is activated when the EN pin is set to high. For proper operation, the pin must be terminated and must not be left floating. With the EN pin set to low, the device enters shutdown mode with less than typ. 70nA current consumption.

### 9.3.4 Power Good Output (PG)

The Power Good comparator features an open drain output. The PG comparator is active with EN pin set to high and  $V_{IN}$  is above the threshold  $V_{TH\_UVLO+}$ . It is driven to high impedance once  $V_{OUT}$  trips the threshold  $V_{TH\_PG+}$  for rising  $V_{OUT}$ . The output is pulled to low level once  $V_{OUT}$  falls below the PG hysteresis,  $V_{PG\_hys}$ . The output is also pulled to low level in case the input voltage  $V_{IN}$  falls below the undervoltage lockout threshold  $V_{TH\_UVLO-}$  or the device is disabled with EN = low. The power good output (PG) can be used as an indicator for the system to signal that the converter has started up and the output voltage is in regulation.

### 9.3.5 Output Voltage Selection (VSEL1 – 4)

The TPS6274x doesn't require an external resistor divider network to program the output voltage. The device integrates a high impedance (typ. 50MΩ) feedback resistor divider network which is programmed by the pins VSEL 1-4. TPS6274x supports an output voltage range of 1.8V to 3.3V in 100mV steps. The output voltage can be changed during operation and supports a simple dynamic output voltage scaling, shown in [Figure 47](#). The output voltage is programmed according to [table Table 1](#).

### 9.3.6 Softstart

When the device is enabled, the internal reference is powered up and after the startup delay time  $t_{Startup\_delay}$  has expired, the device enters softstart, starts switching and ramps up the output voltage. During softstart the device operates with a reduced current limit,  $I_{LIM\_softstart}$ , of typ. 1/4 of the nominal current limit. This reduced current limit is active during the softstart time  $t_{Softstart}$ . The current limit is increased to its nominal value,  $I_{LIMF}$ , once the softstart time has expired.

## Feature Description (continued)

### 9.3.7 Undervoltage Lockout UVLO

The device includes an under-voltage lockout (UVLO) comparator which prevents the device from misoperation at too low input voltages. The UVLO comparator becomes active once the device is enabled with EN set to high. Once the input voltage trips the UVLO threshold  $V_{TH\_UVLO+}$  (typically 2.075V) for rising  $V_{IN}$ , the UVLO comparator releases the device for start up and operation. With a falling input voltage, the device operates down to the UVLO threshold level  $V_{TH\_UVLO-}$  (typically 1.925V). Once this threshold is tripped, the device stops switching, the load switch at pin LOAD is disabled and both rails, VOUT and LOAD are discharged. The converter starts operation again once the input voltage trips the rising UVLO threshold level  $V_{TH\_UVLO+}$ .

## 9.4 Device Functional Modes

### 9.4.1 VOUT And LOAD Output Discharge

Both the VOUT pin and the LOAD pin feature a discharge circuit to connect each rail to GND, once they are disabled. This feature prevents residual charge voltages on capacitors connected to these pins, which may impact proper power up of the main- and sub-system. With CTRL pin pulled to low, the discharge circuit at the LOAD pin becomes active. With the EN pin pulled to low, the discharge circuits at both pins VOUT and Load are active. The discharge circuits of both rails VOUT and LOAD are associated with the UVLO comparator as well. Both discharge circuits become active once the UVLO comparator triggers and the input voltage  $V_{IN}$  has dropped below the UVLO comparator threshold  $V_{TH\_UVLO-}$  (typ. 1.925V).

### 9.4.2 Automatic Transition Into 100% Mode

Once the input voltage comes close to the output voltage, the DC/DC converter stops switching and enters 100% duty cycle operation. It connects the output VOUT via the inductor and the internal high side MOSFET switch to the input VIN, once the input voltage  $V_{IN}$  falls below the 100% mode enter threshold,  $V_{TH\_100-}$ . The DC/DC regulator is turned off, not switching and therefore it generates no output ripple voltage. Because the output is connected to the input, the output voltage tracks the input voltage minus the voltage drop across the internal high side switch and the inductor caused by the output current. Once the input voltage increases and trips the 100% mode leave threshold,  $V_{TH\_100+}$ , the DC/DC regulator turns on and starts switching again. See [Figure 6](#), [Figure 49](#), [Figure 50](#), [Figure 51](#).

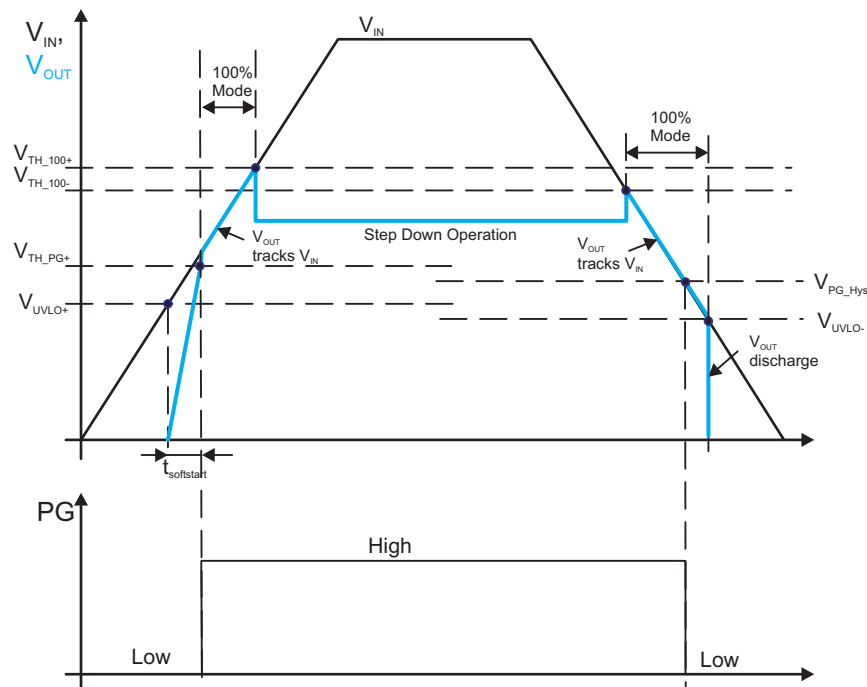

**Figure 6. Automatic 100% Mode Transition**

## Device Functional Modes (continued)

### 9.4.3 Internal Current Limit

The TPS6274x integrates a current limit on the high side, as well the low side MOSFETs to protect the device against overload or short circuit conditions. The peak current in the switches is monitored cycle by cycle. If the high side MOSFET current limit is reached, the high side MOSFET is turned off and the low side MOSFET is turned on until the current decreases below the low side MOSFET current limit.

### 9.4.4 Dynamic Voltage Scaling with VSEL Interface

During operation, the output voltage of the device can be changed, see [Figure 47](#). The device will not actively ramp down the output voltage from a higher to a lower level.

## 10 Application and Implementation

### 10.1 Application Information

The TPS6274x devices are a step down converter family featuring typ. 360nA quiescent current and operating with a tiny 2.2μH inductor and 10μF output capacitor. This new DCS-Control™ based devices extend the light load efficiency range below 10μA load currents. TPS62740 supports output currents up to 300mA, TPS62742 up to 400mA. The devices operate from rechargeable Li-Ion batteries, Li-primary battery chemistries such as Li-SOCl<sub>2</sub>, Li-MnO<sub>2</sub> and two or three cell alkaline batteries.

### 10.2 Typical Application

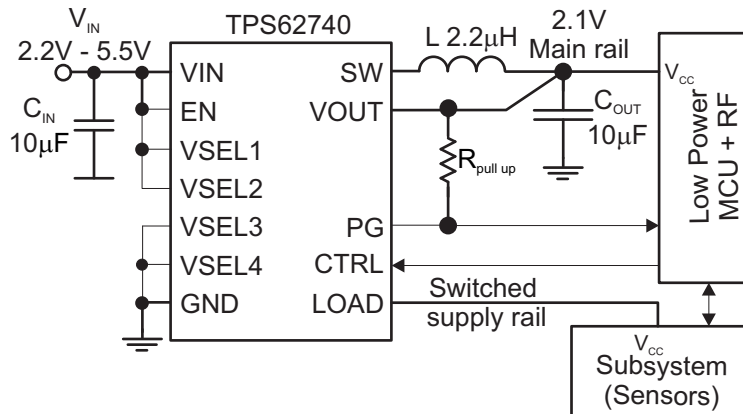

**Figure 7. TPS62740 Typical Application Circuit**

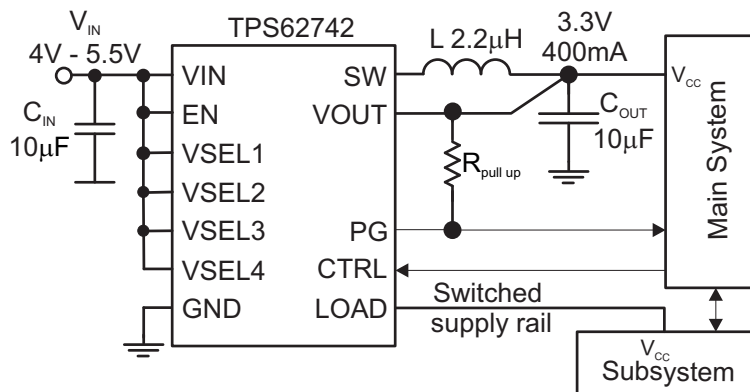

**Figure 8. TPS62742 Typical Application Circuit**

#### 10.2.1 Design Requirements

The TPS6274x is a highly integrated DC/DC converter. The output voltage is set via a VSEL pin interface without any additional external components. For proper operation only a input- and output capacitor and an inductor is required. The integrated load switch doesn't require a capacitor on its LOAD pin. Table 2 shows the components used for the application characteristic curves.

**Table 2. Components for Application Characteristic Curves**

Reference	Description	Value	Manufacturer
TPS62740/42	360nA Iq step down converter		Texas Instruments
CIN, COUT, CLOAD	Ceramic capacitor GRM188R60J106M	10μF	Murata
L	Inductor LPS3314	2.2μH	Coilcraft

### 10.2.2 Detailed Design Procedure

Table 3 shows the recommended output filter components. The TPS6274x is optimized for operation with a 2.2μH inductor and with 10μF output capacitor.

**Table 3. Recommended LC Output Filter Combinations**

Inductor Value [μH] <sup>(1)</sup>	Output Capacitor Value [μF] <sup>(2)</sup>		
	4.7μF	10μF	22μF
2.2	√	√ <sup>(3)</sup>	√

- (1) Inductor tolerance and current de-rating is anticipated. The effective inductance can vary by 20% and -30%.
- (2) Capacitance tolerance and bias voltage de-rating is anticipated. The effective capacitance can vary by 20% and -50%.
- (3) This LC combination is the standard value and recommended for most applications.

#### 10.2.2.1 Inductor Selection

The inductor value affects its peak-to-peak ripple current, the PWM-to-PFM transition point, the output voltage ripple and the efficiency. The selected inductor has to be rated for its DC resistance and saturation current. The inductor ripple current ( $\Delta I_L$ ) decreases with higher inductance and increases with higher  $V_{IN}$  or  $V_{OUT}$  and can be estimated according to Equation 1.

Equation 2 calculates the maximum inductor current under static load conditions. The saturation current of the inductor should be rated higher than the maximum inductor current, as calculated with Equation 2. This is recommended because during a heavy load transient the inductor current rises above the calculated value. A more conservative way is to select the inductor saturation current above the high-side MOSFET switch current limit,  $I_{LIMF}$ .

$$\Delta I_L = V_{out} \times \frac{1 - \frac{V_{out}}{V_{in}}}{L \times f} \quad (1)$$

$$I_{Lmax} = I_{outmax} + \frac{\Delta I_L}{2} \quad (2)$$

With:

f = Switching Frequency

L = Inductor Value

$\Delta I_L$  = Peak to Peak inductor ripple current

$I_{Lmax}$  = Maximum Inductor current

In DC/DC converter applications, the efficiency is essentially affected by the inductor AC resistance (i.e. quality factor) and by the inductor DCR value. Increasing the inductor value produces lower RMS currents, but degrades transient response. For a given physical inductor size, increased inductance usually results in an inductor with lower saturation current.

The total losses of the coil consist of both the losses in the DC resistance ( $R_{DC}$ ) and the following frequency-dependent components:

- The losses in the core material (magnetic hysteresis loss, especially at high switching frequencies)
- Additional losses in the conductor from the skin effect (current displacement at high frequencies)
- Magnetic field losses of the neighboring windings (proximity effect)
- Radiation losses

The following inductor series from different suppliers have been used:

**Table 4. List Of Inductors<sup>(1)</sup>**

INDUCTANCE [ $\mu$ H]	DIMENSIONS [ $\text{mm}^3$ ]	INDUCTOR TYPE	SUPPLIER
2.2	3.3 x 3.3 x 1.4	LPS3314	Coilcraft
2.2	2.5 x 3.0 x 1.5	VLF302515MT	TDK
2.2	2.0 x 1.2 x 1.0	MIPSZ2012 2R2	FDK
2.2	2.5 x 2.0 x 1.2	MIPSA2520 2R2	FDK
2.2	2.0 x 1.2 x 1.0	MDT2012CH2R2	TOKO

(1) See [Third-party Products Disclaimer](#)

### 10.2.2.2 DC/DC Output Capacitor Selection

The DCS-Control™ scheme of the TPS6274x allows the use of tiny ceramic capacitors. Ceramic capacitors with low ESR values have the lowest output voltage ripple and are recommended. The output capacitor requires either an X7R or X5R dielectric. Y5V and Z5U dielectric capacitors, aside from their wide variation in capacitance over temperature, become resistive at high frequencies. At light load currents, the converter operates in Power Save Mode and the output voltage ripple is dependent on the output capacitor value and the PFM peak inductor current. A larger output capacitors can be used, but it should be considered that larger output capacitors lead to an increased leakage current in the capacitor and may reduce overall conversion efficiency. Furthermore, larger output capacitors impact the start up behavior of the DC/DC converter.

### 10.2.2.3 Input Capacitor Selection

Because the buck converter has a pulsating input current, a low ESR input capacitor is required for best input voltage filtering to ensure proper function of the device and to minimize input voltage spikes. For most applications a 10 $\mu$ F is sufficient. The input capacitor can be increased without any limit for better input voltage filtering.

[Table 5](#) shows a list of tested input/output capacitors.

**Table 5. List Of Capacitors<sup>(1)</sup>**

CAPACITANCE [ $\mu$ F]	SIZE	CAPACITOR TYPE	SUPPLIER
10	0603	GRM188R60J106ME84	Murata

(1) See [Third-party Products Disclaimer](#)

10.2.3 Application Curves

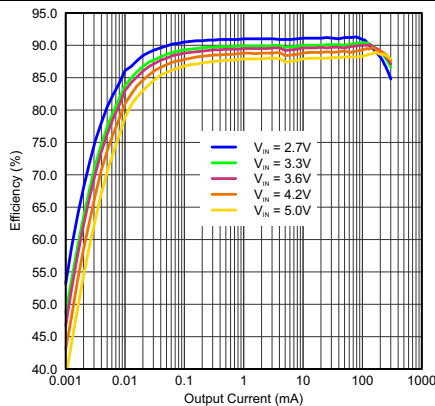

$C_{OUT} = 10 \mu F$  (0603)  $CTRL = GND$   
 $L = 2.2 \mu H$  (LPS3314 2R2)

Figure 9. Efficiency  $V_{OUT} = 1.8V$

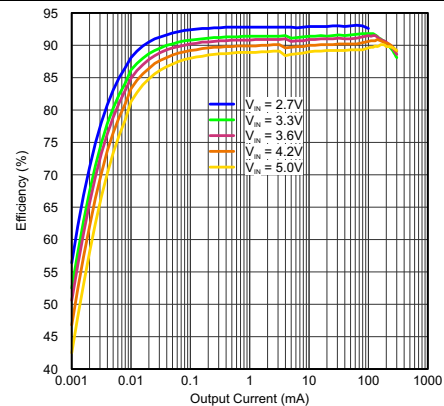

$C_{OUT} = 10 \mu F$  (0603)  $CTRL = GND$   
 $L = 2.2 \mu H$  (LPS3314 2R2)

Figure 10. Efficiency  $V_{OUT} = 2.1V$

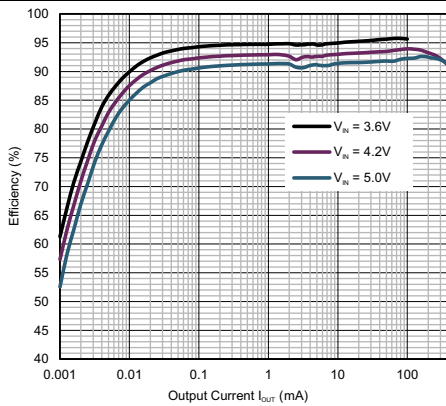

$C_{OUT} = 10 \mu F$ ,  $CTRL = GND$   
 $L = 2.2 \mu H$  (VLF302515)

Figure 11. Efficiency  $V_{OUT} = 3.3V$  TPS62742

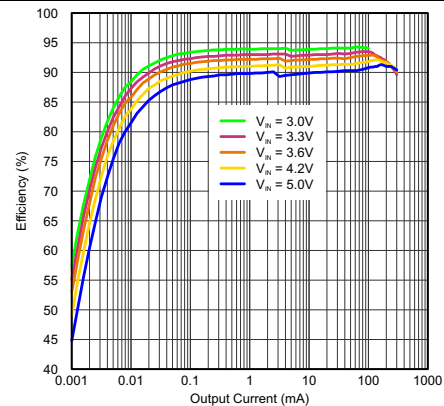

$C_{OUT} = 10 \mu F$  (0603)  $CTRL = GND$   
 $L = 2.2 \mu H$  (LPS3314 2R2)

Figure 12. Efficiency  $V_{OUT} = 2.5V$

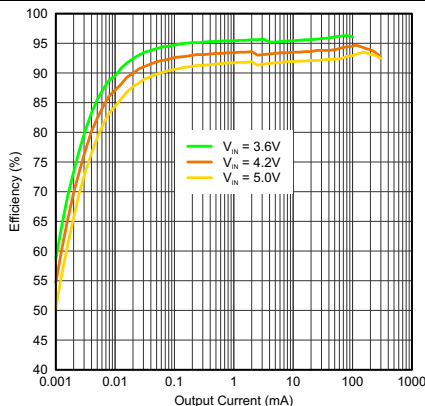

$C_{OUT} = 10 \mu F$  (0603)  $CTRL = GND$   
 $L = 2.2 \mu H$  (LPS3314 2R2)

Figure 13. Efficiency  $V_{OUT} = 3.3V$

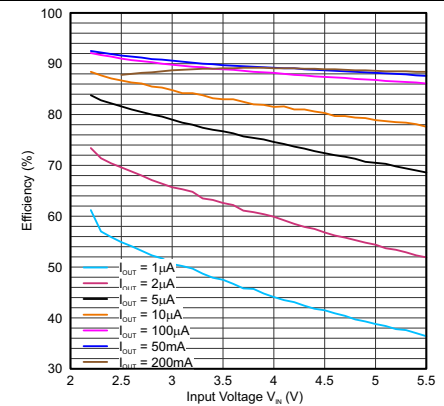

$C_{OUT} = 10 \mu F$  (0603)  $CTRL = GND$   
 $L = 2.2 \mu H$  (LPS3314 2R2)

Figure 14. Efficiency  $V_{OUT} = 1.8V$

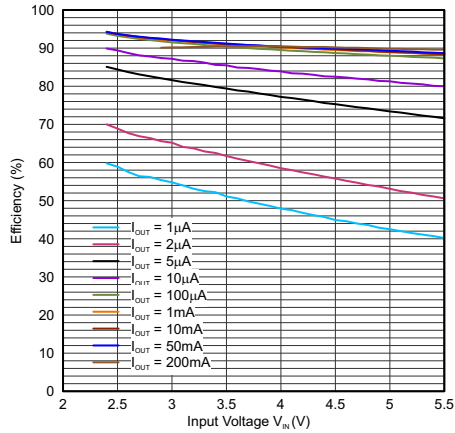

$C_{OUT} = 10 \mu F$  (0603) CTRL = GND  
L = 2.2  $\mu H$  (LPS3314 2R2)

Figure 15. Efficiency  $V_{OUT} = 2.1V$

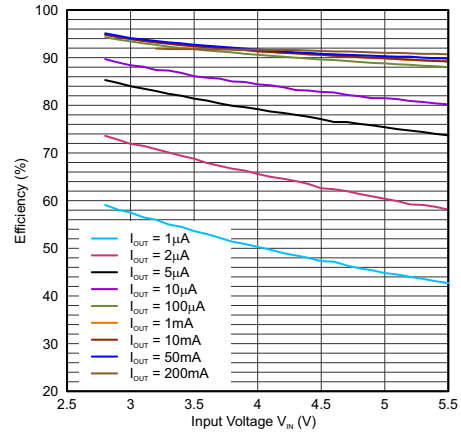

$C_{OUT} = 10 \mu F$  (0603) CTRL = GND  
L = 2.2  $\mu H$  (LPS3314 2R2)

Figure 16. Efficiency  $V_{OUT} = 2.5V$

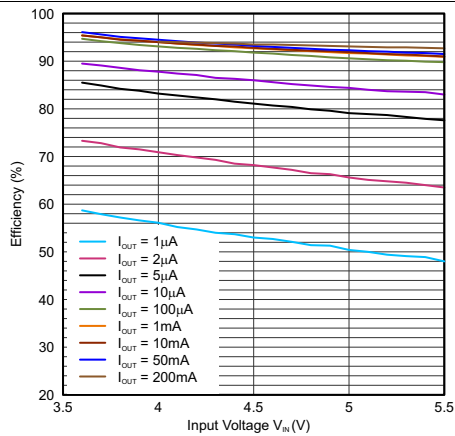

$C_{OUT} = 10 \mu F$  (0603) CTRL = GND  
L = 2.2  $\mu H$  (LPS3314 2R2)

Figure 17. Efficiency  $V_{OUT} = 3.3V$

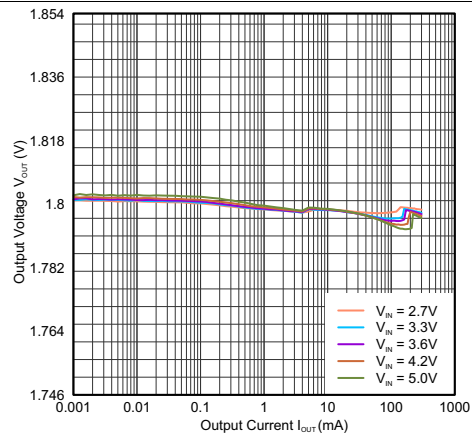

$C_{OUT} = 10 \mu F$  (0603) CTRL = GND  
L = 2.2  $\mu H$  (LPS3314 2R2)

Figure 18. Output Voltage  $V_{OUT} = 1.8V$

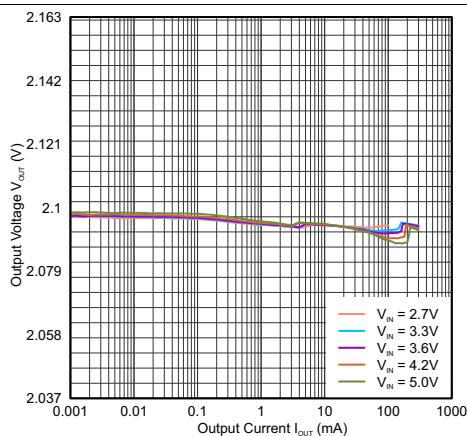

$C_{OUT} = 10 \mu F$  (0603) CTRL = GND  
L = 2.2  $\mu H$  (LPS3314 2R2)

Figure 19. Output Voltage  $V_{OUT} = 2.1V$

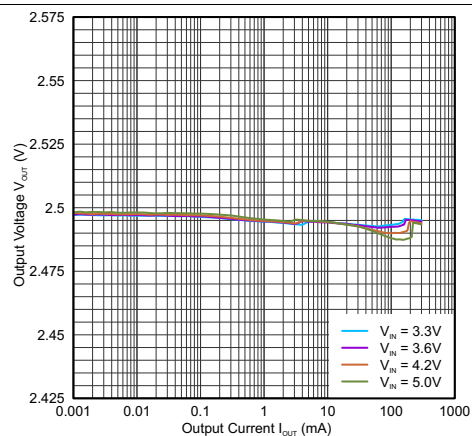

$C_{OUT} = 10 \mu F$  (0603) CTRL = GND  
L = 2.2  $\mu H$  (LPS3314 2R2)

Figure 20. Output Voltage  $V_{OUT} = 2.5V$



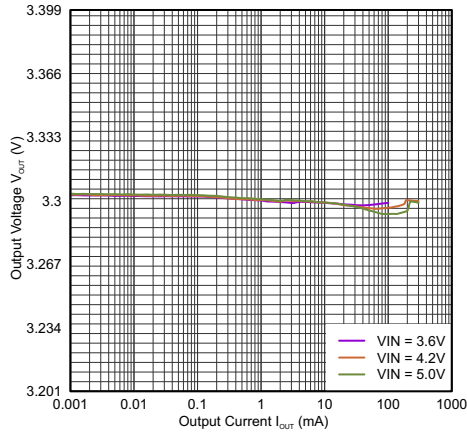

$C_{OUT} = 10 \mu F$  (0603) CTRL = GND  
L = 2.2  $\mu H$  (LPS3314 2R2)

Figure 21. Output Voltage  $V_{OUT} = 3.3V$

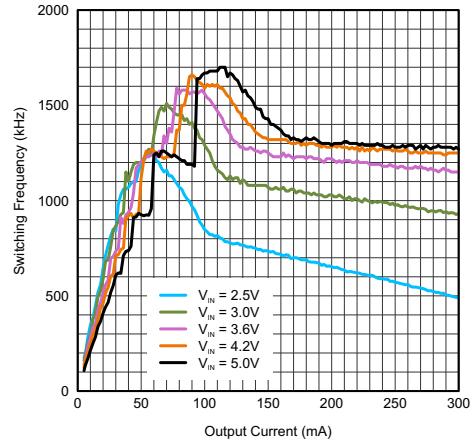

$C_{OUT} = 10 \mu F$  L = 2.2  $\mu H$

Figure 22. Typical Switching Frequency  $V_{OUT} = 1.8V$

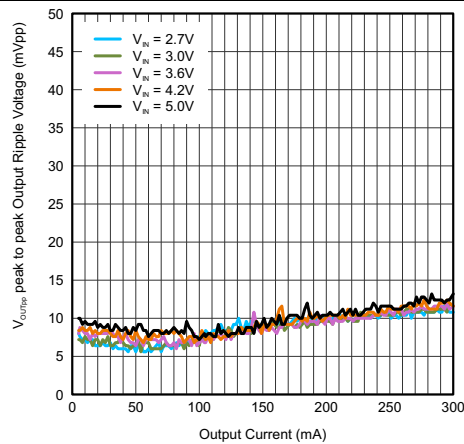

$C_{OUT} = 10 \mu F$  (0603) CTRL = GND  
L = 2.2  $\mu H$

Figure 23. Typical Output Ripple Voltage  $V_{OUT} = 1.8V$

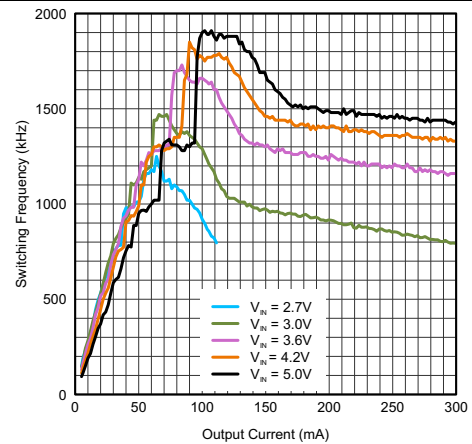

$C_{OUT} = 10 \mu F$  L = 2.2  $\mu H$

Figure 24. Typical Switching Frequency  $V_{OUT} = 2.1V$

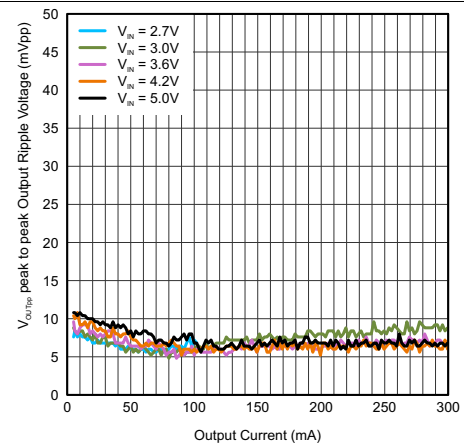

$C_{OUT} = 10 \mu F$  (0603) CTRL = GND  
L = 2.2  $\mu H$

Figure 25. Typical Output Ripple Voltage  $V_{OUT} = 2.1V$

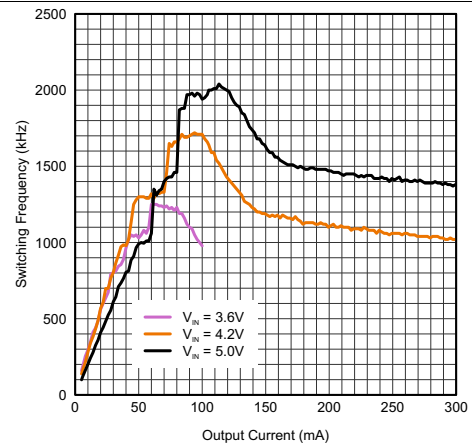

$C_{OUT} = 10 \mu F$  L = 2.2  $\mu H$

Figure 26. Typical Switching Frequency  $V_{OUT} = 3.0V$

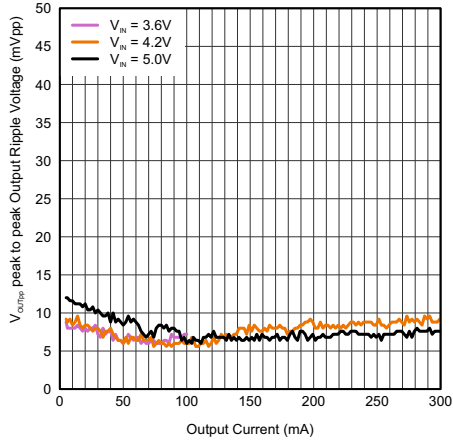

$C_{OUT} = 10 \mu\text{F}$  (0603)

CTRL = GND  
L = 2.2  $\mu\text{H}$

Figure 27. Typical Output Ripple Voltage  $V_{OUT} = 3.0\text{V}$

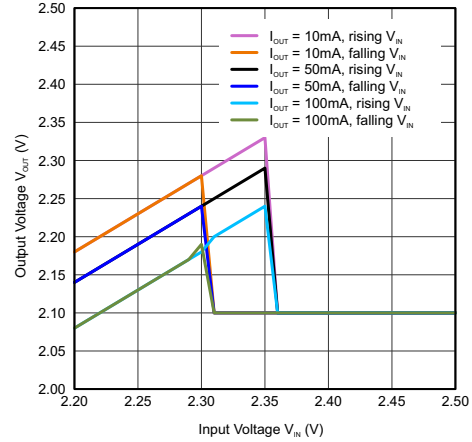

L = 2.2  $\mu\text{H}$  (LPS3314)

Figure 28. 100% Mode Transition  $V_{OUT} 2.1\text{V}$

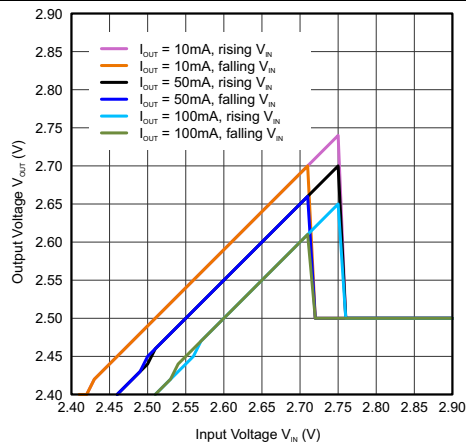

L = 2.2  $\mu\text{H}$  (LPS3314)

Figure 29. 100% Mode Transition  $V_{OUT} 2.5\text{V}$

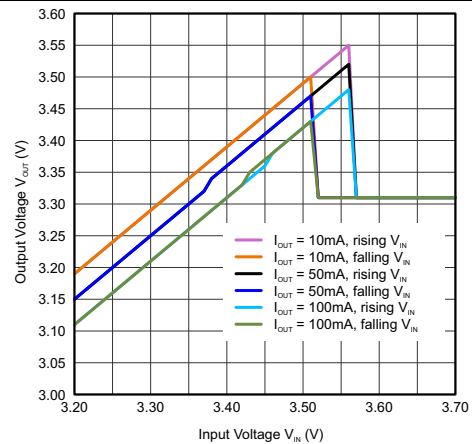

L = 2.2  $\mu\text{H}$  (LPS3314)

Figure 30. 100% Mode Transition  $V_{OUT} 3.3\text{V}$

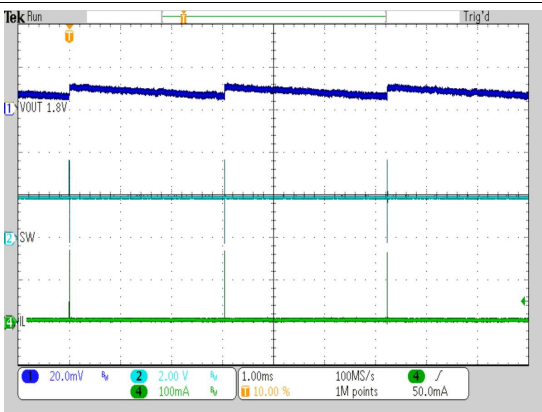

$V_{IN} = 3.6 \text{ V}$

$I_{OUT} = 10 \mu\text{A}$

L = 2.2  $\mu\text{H}$

$C_{OUT} = 10 \mu\text{F}$

CTRL = GND

Figure 31. Typical Operation  $I_{Load} = 10\mu\text{A}$   $V_{OUT} = 1.8\text{V}$

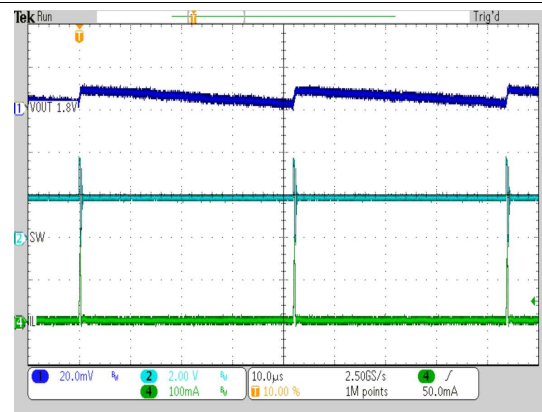

$V_{IN} = 3.6 \text{ V}$

$I_{OUT} = 1 \text{ mA}$

L = 2.2  $\mu\text{H}$

$C_{OUT} = 10 \mu\text{F}$

CTRL = GND

Figure 32. Typical Operation  $I_{Load} = 1\text{ma}$   $V_{OUT} = 1.8\text{V}$

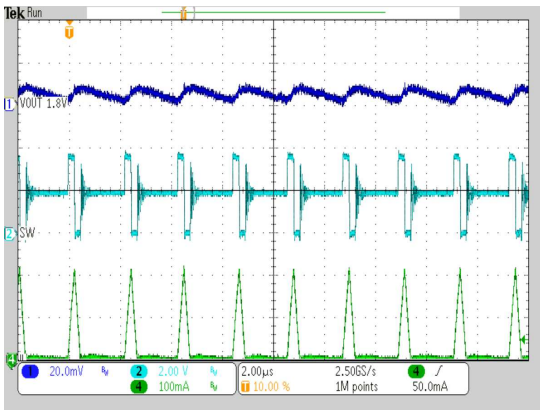

$V_{IN} = 3.6\text{ V}$        $I_{OUT} = 25\text{ mA}$        $L = 2.2\ \mu\text{H}$   
 $C_{OUT} = 10\ \mu\text{F}$        $\text{CTRL} = \text{GND}$

Figure 33. Typical Operation  $I_{Load} = 25\text{mA}$ ,  $V_{OUT} = 1.8\text{V}$

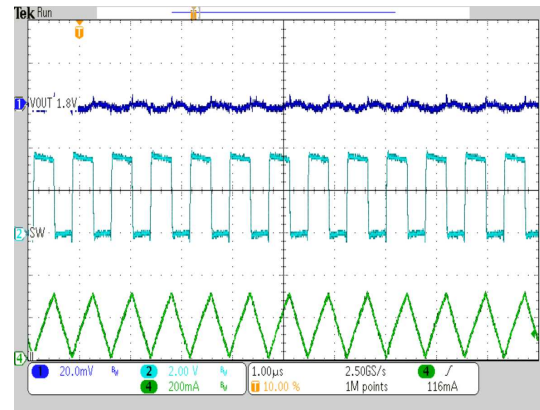

$V_{IN} = 3.6\text{ V}$        $I_{OUT} = 150\text{ mA}$        $L = 2.2\ \mu\text{H}$   
 $C_{OUT} = 10\ \mu\text{F}$        $\text{CTRL} = \text{GND}$

Figure 34. Typical Operation  $I_{Load} = 150\text{mA}$ ,  $V_{OUT} = 1.8\text{V}$

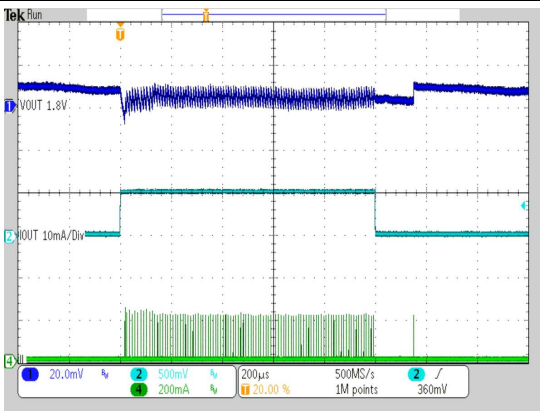

$V_{IN} = 3.6\text{ V}$        $I_{OUT} = 50\ \mu\text{A}$  to  $10\text{ mA}$        $L = 2.2\ \mu\text{H}$   
 $C_{OUT} = 10\ \mu\text{F}$        $\text{CTRL} = \text{GND}$

Figure 35. Load Transient Response  $V_{OUT} = 1.8\text{V}$

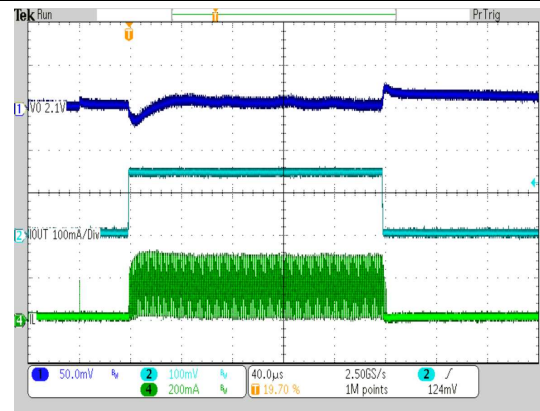

$V_{IN} = 3.6\text{ V}$        $I_{OUT} = 0.5\text{ mA}$  to  $150\text{ mA}$        $L = 2.2\ \mu\text{H}$   
 $C_{OUT} = 10\ \mu\text{F}$        $\text{CTRL} = V_{IN}$

Figure 36. Load Transient Response  $V_{OUT} = 2.1\text{V}$

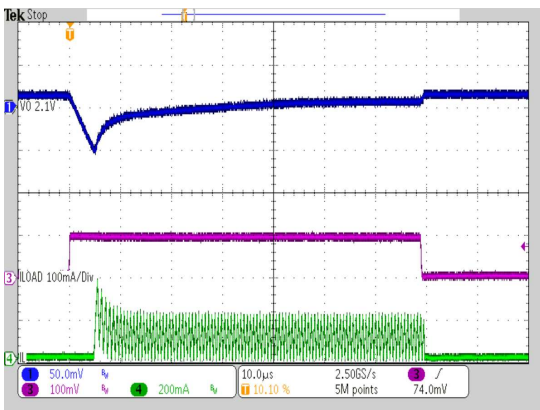

$V_{IN} = 3.6\text{ V}$ ,  $V_{OUT} = 2.1\text{ V}$        $L = 2.2\ \mu\text{H}$        $C_{OUT} = 10\ \mu\text{F}$   
 Loadstep at  $V_{OUT}$  0 mA to 100 mA,  
 1  $\mu\text{s}$  rise/ fall time, 70  $\mu\text{s}$  / 7 ms

Figure 37. Load Transient Response  $\text{CTRL} = \text{GND}$

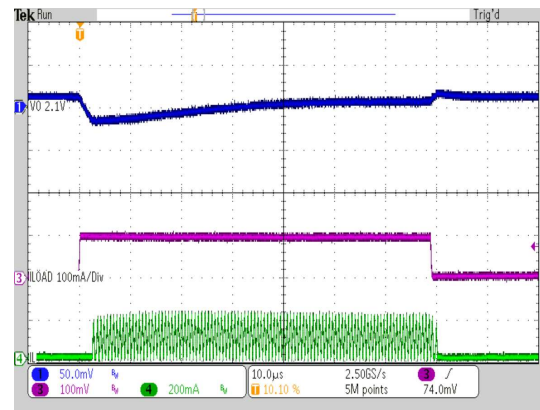

$V_{IN} = 3.6\text{ V}$ ,  $V_{OUT} = 2.1\text{ V}$        $L = 2.2\ \mu\text{H}$ ,       $C_{OUT} = 10\ \mu\text{F}$   
 Loadstep at  $V_{OUT}$  0 mA to 100 mA,  
 1  $\mu\text{s}$  rise/fall time; 70  $\mu\text{s}$  / 7 ms

Figure 38. Load Transient Response  $\text{CTRL} = V_{IN}$

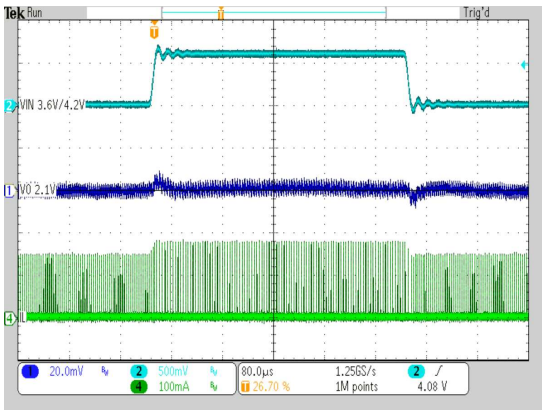

$V_{IN} = 3.6\text{ V} / 4.2\text{ V}$        $V_{OUT} = 2.1\text{ V}$        $L = 2.2\text{ }\mu\text{H}$   
 $C_{OUT} = 10\text{ }\mu\text{F}$        $C_{TRL} = \text{GND}$

Figure 39. Line Transient Response  $I_{OUT}=10\text{mA}$

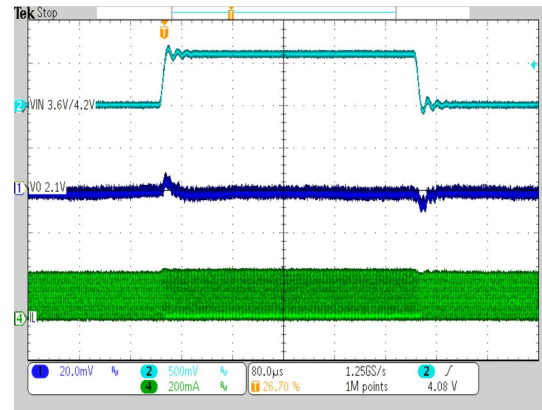

$V_{IN} = 3.6\text{ V} / 4.2\text{ V}$        $V_{OUT} = 2.1\text{ V}$        $L = 2.2\text{ }\mu\text{H}$   
 $C_{OUT} = 10\text{ }\mu\text{F}$        $C_{TRL} = \text{GND}$

Figure 40. Line Transient Response  $I_{OUT} = 100\text{mA}$

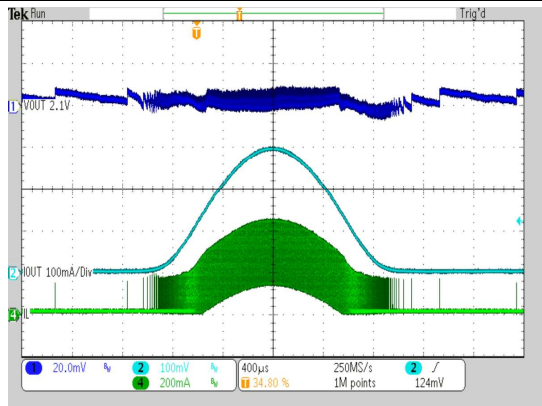

$V_{IN} = 3.6\text{ V}$        $I_{OUT} = 50\text{ }\mu\text{A}$  to  $300\text{ mA}$        $L = 2.2\text{ }\mu\text{H}$   
 $C_{OUT} = 10\text{ }\mu\text{F}$        $C_{TRL} = \text{GND}$

Figure 41. AC Load Sweep  $V_{OUT} = 2.1\text{V}$

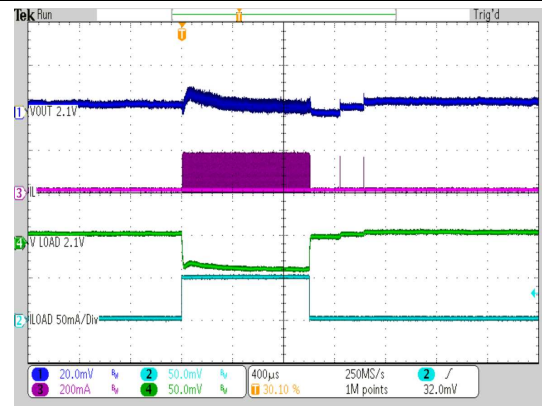

$V_{IN} = 3.6\text{ V}$ ,       $V_{OUT} = V_{LOAD} = 2.1\text{ V}$        $C_{TRL} = V_{IN}$   
 $I_{OUT} = 0\text{ mA}$        $C_{LOAD} = 10\text{ }\mu\text{F}$        $L = 2.2\text{ }\mu\text{H}$   
 $C_{OUT} = 10\text{ }\mu\text{F}$        $I_{LOAD} = 0$  to  $50\text{ mA}$  to  $0\text{ mA}$

Figure 42. Load Step At Load Output

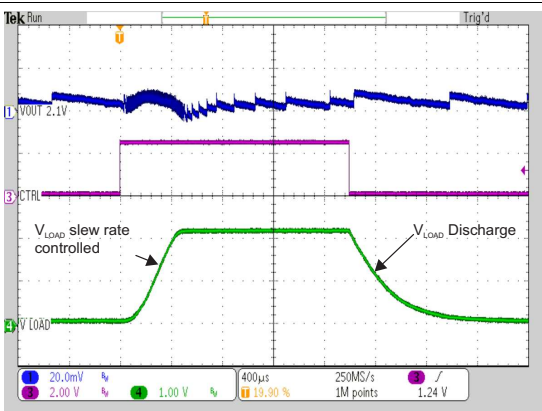

$V_{IN} = 3.6\text{ V}$        $V_{OUT} = 2.1\text{ V}$        $I_{LOAD} = 0\text{ mA}$   
 $I_{OUT} = 0\text{ mA}$        $C_{OUT} = 10\text{ }\mu\text{F}$        $C_{LOAD} = 10\text{ }\mu\text{F}$   
 $L = 2.2\text{ }\mu\text{H}$

Figure 43. Load Output On / Off

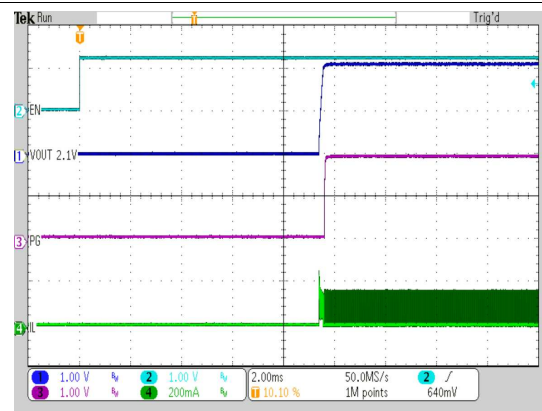

$V_{IN} = 3.6\text{ V}$        $V_{OUT} = 2.1\text{ V}$        $C_{TRL} = \text{GND}$   
 $R_{OUT} = 100\text{ }\Omega$        $C_{OUT} = 10\text{ }\mu\text{F}$        $L = 2.2\text{ }\mu\text{H}$

Figure 44. Device Enable And Start Up

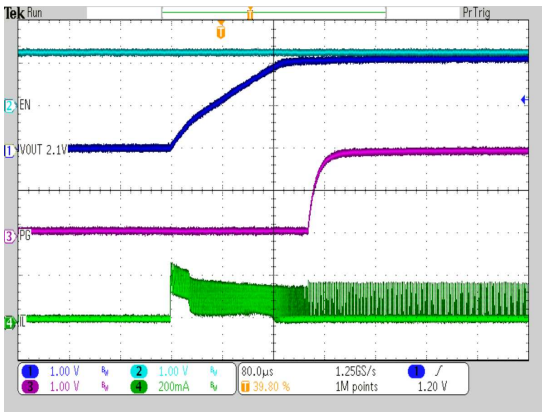

$V_{IN} = 3.6\text{ V}$        $V_{OUT} = 2.1\text{ V}$       CTRL = GND  
 $R_{OUT} = 100\ \Omega$        $C_{OUT} = 10\ \mu\text{F}$       L = 2.2  $\mu\text{H}$

Figure 45.  $V_{OUT}$  Ramp Up After Enable

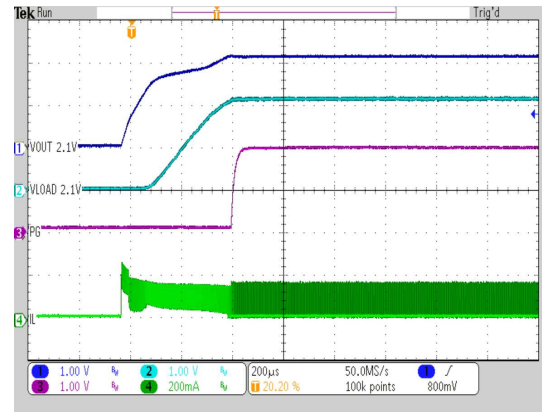

$V_{IN} = 3.6\text{ V}$        $V_{OUT} = V_{LOAD} = 2.1\text{ V}$       CTRL =  $V_{IN}$   
 $R_{OUT} = 100\ \Omega$ ,       $C_{OUT} = C_{LOAD} = 10\ \mu\text{F}$       L = 2.2  $\mu\text{H}$   
 $I_{LOAD} = 0\text{ mA}$

Figure 46.  $V_{OUT}$  Ramp Up With Activated Load Switch

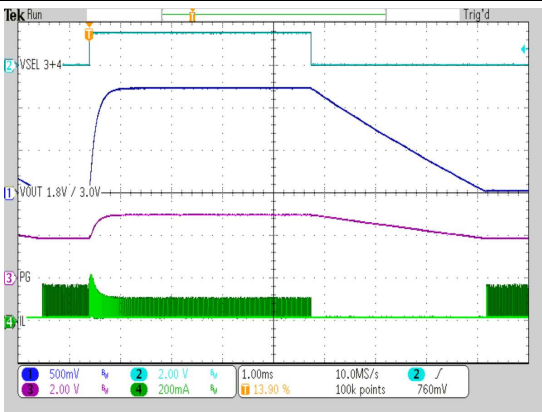

$V_{IN} = 3.6\text{ V}$       Ramp up / Down  
 $C_{OUT} = 10\ \mu\text{F}$       CTRL = GND      VSEL 3+4 toggled  
 $I_{OUT} = 5\text{ mA}$       L = 2.2  $\mu\text{H}$       VSEL 1+2 = GND

Figure 47. Dynamic Output Voltage Scaling  
 $V_{OUT} = 1.8\text{V}/3.0\text{V}$

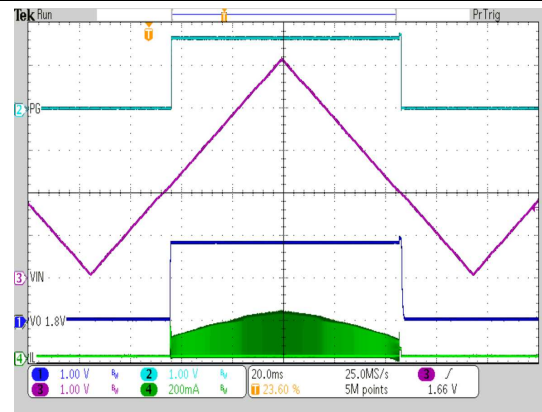

$C_{OUT} = 10\ \mu\text{F}$       L = 2.2  $\mu\text{H}$       CTRL = GND  
 $V_{IN} = \text{ramp up/down } 0\text{ V to } 5\text{ V, } 150\text{ ms,}$   
 Output resistance 50  $\Omega$

Figure 48. Input Voltage Ramp Up/Down  
 $V_{OUT} = 1.8\text{V}$

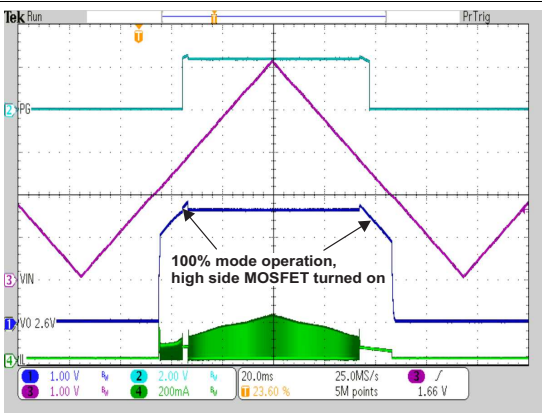

$C_{OUT} = 10\ \mu\text{F}$       L = 2.2  $\mu\text{H}$       CTRL = GND  
 $V_{IN} = \text{ramp up/down } 0\text{ V to } 5\text{ V, } 150\text{ ms,}$   
 Output resistance 50  $\Omega$

Figure 49. Input Voltage Ramp Up/Down  $V_{OUT} = 2.6\text{V}$

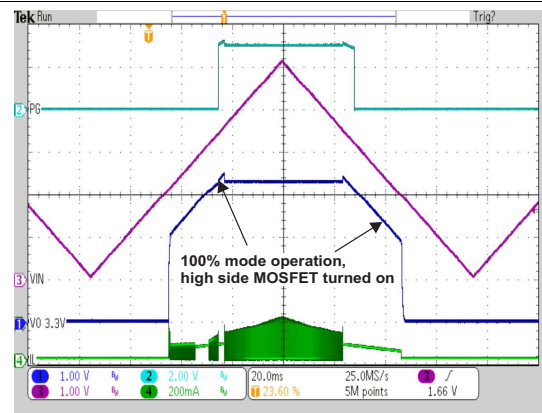

$C_{OUT} = 10\ \mu\text{F}$       L = 2.2  $\mu\text{H}$       CTRL = GND  
 $V_{IN} = \text{ramp up/down } 0\text{ V to } 5\text{ V, } 150\text{ ms,}$   
 Output resistance 50  $\Omega$

Figure 50. Input Voltage Ramp Up/Down  $V_{OUT} = 3.3\text{V}$

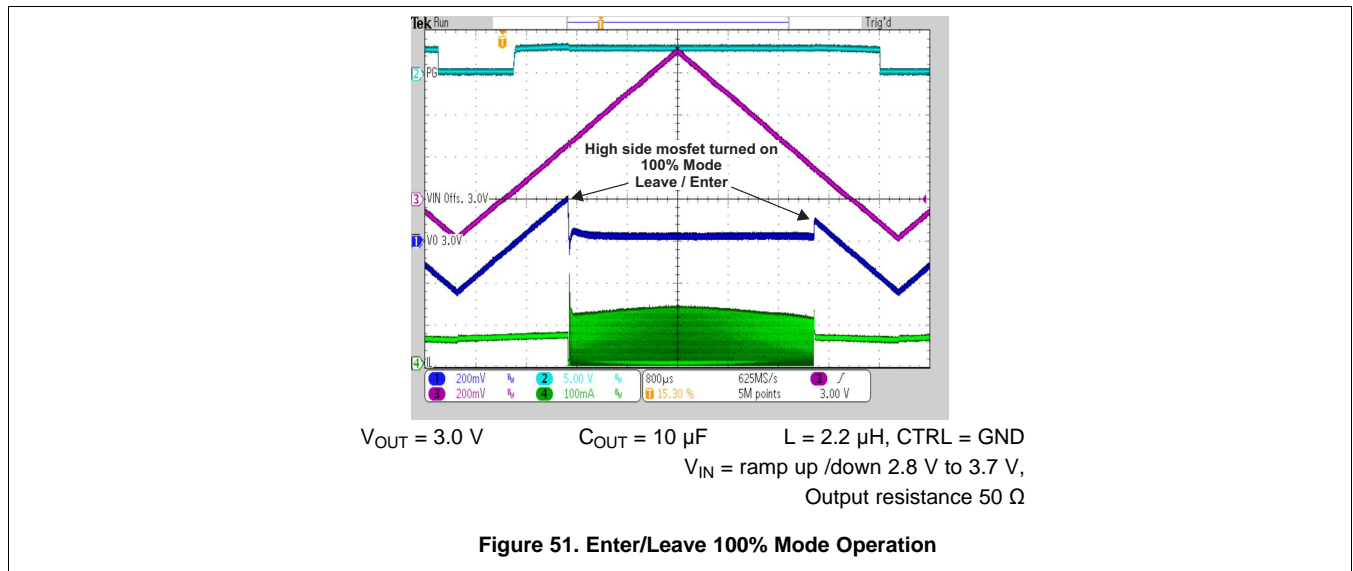

### 10.3 System Example

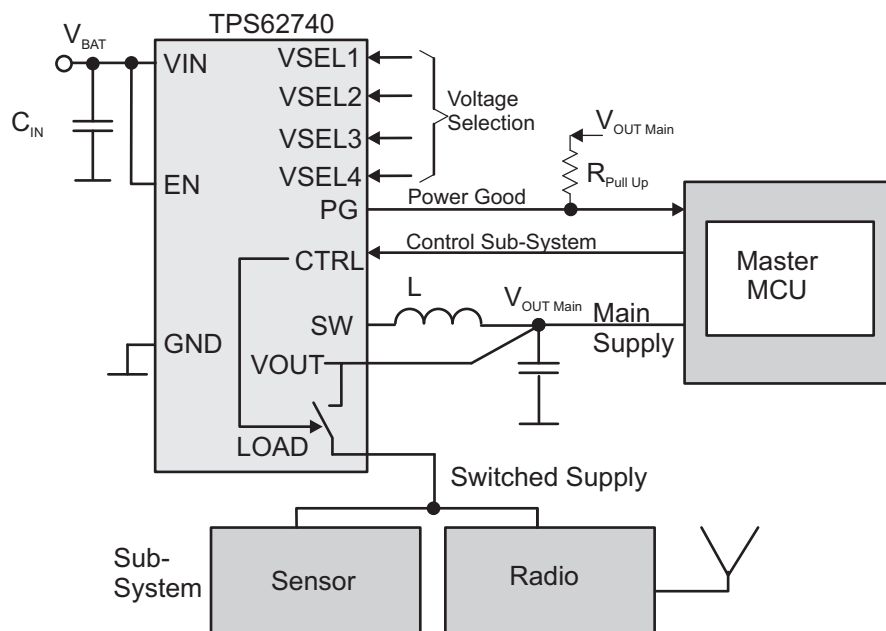

**Figure 52. Example Of Implementation In A Master MCU Based System**

## 11 Power Supply Recommendations

The power supply to the TPS6274x needs to have a current rating according to the supply voltage, output voltage and output current of the TPS6274x.

## 12 Layout

### 12.1 Layout Guidelines

As for all switching power supplies, the layout is an important step in the design. Care must be taken in board layout to get the specified performance. If the layout is not carefully done, the regulator could show poor line and/or load regulation, stability issues as well as EMI problems and interference with RF circuits. It is critical to provide a low inductance, impedance ground path. Therefore, use wide and short traces for the main current paths. The input capacitor should be placed as close as possible to the IC pins VIN and GND. The output capacitor should be placed close between VOUT and GND pins. The VOUT line should be connected to the output capacitor and routed away from noisy components and traces (e.g. SW line) or other noise sources. The exposed thermal pad of the package and the GND pin should be connected. See [Figure 53](#) for the recommended PCB layout.

### 12.2 Layout Example

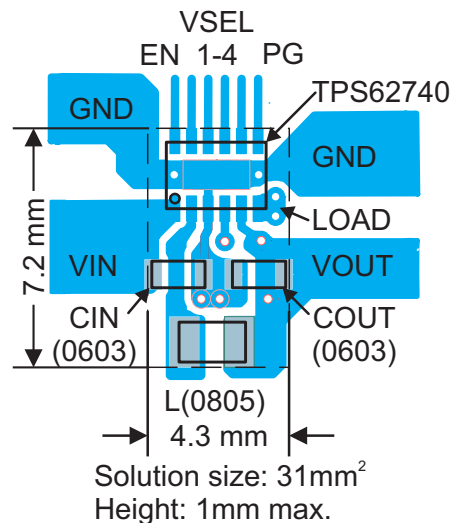

Figure 53. Recommended PCB Layout

## 13 器件和文档支持

### 13.1 器件支持

#### 13.1.1 第三方产品免责声明

TI 发布的与第三方产品或服务有关的信息，不能构成与此类产品或服务或保修的适用性有关的认可，不能构成此类产品或服务单独或与任何 TI 产品或服务一起的表示或认可。

### 13.2 文档支持

#### 13.2.1 相关文档

另请参见《TPS62740EVM-186 评估模块用户指南》，[SLVU949](#)；和应用笔记《精确测量超低 IQ 器件的效率》，[SLYT558](#)，以便在 PFM 模式操作下精确测量效率。

### 13.3 相关链接

以下表格列出了快速访问链接。范围包括技术文档、支持与社区资源、工具和软件，并且可以快速访问样片或购买链接。

表 6. 相关链接

器件	产品文件夹	样片与购买	技术文档	工具与软件	支持与社区
TPS62740	<a href="#">请单击此处</a>	<a href="#">请单击此处</a>	<a href="#">请单击此处</a>	<a href="#">请单击此处</a>	<a href="#">请单击此处</a>
TPS62742	<a href="#">请单击此处</a>	<a href="#">请单击此处</a>	<a href="#">请单击此处</a>	<a href="#">请单击此处</a>	<a href="#">请单击此处</a>

### 13.4 商标

DCS-Control is a trademark of Texas Instruments.  
is a registered trademark of ~Bluetooth SIG, Inc.

### 13.5 静电放电警告



这些装置包含有限的内置 ESD 保护。存储或装卸时，应将导线一起截短或将装置放置于导电泡棉中，以防止 MOS 门极遭受静电损伤。

### 13.6 术语表

[SLYZ022](#) — TI 术语表。

这份术语表列出并解释术语、首字母缩略词和定义。

## 14 机械封装和可订购信息

以下页中包括机械封装和可订购信息。 这些信息是针对指定器件可提供的最新数据。 这些数据会在无通知且不对本文档进行修订的情况下发生改变。 欲获得该数据表的浏览器版本，请查阅左侧的导航栏。



## 重要声明

德州仪器(TI)及其下属子公司有权根据 JESD46 最新标准,对所提供的产品和服务进行更正、修改、增强、改进或其它更改,并有权根据 JESD48 最新标准中止提供任何产品和服务。客户在下订单前应获取最新的相关信息,并验证这些信息是否完整且是最新的。所有产品的销售都遵循在订单确认时所提供的TI 销售条款与条件。

TI 保证其所销售的组件的性能符合产品销售时 TI 半导体产品销售条件与条款的适用规范。仅在 TI 保证的范围内,且 TI 认为有必要时才会使用测试或其它质量控制技术。除非适用法律做出了硬性规定,否则没有必要对每种组件的所有参数进行测试。

TI 对应用帮助或客户产品设计不承担任何义务。客户应对其使用 TI 组件的产品和应用自行负责。为尽量减小与客户产品和应用相关的风险,客户应提供充分的设计与操作安全措施。

TI 不对任何 TI 专利权、版权、屏蔽作品权或其它与使用了 TI 组件或服务的组合设备、机器或流程相关的 TI 知识产权中授予的直接或隐含权限作出任何保证或解释。TI 所发布的与第三方产品或服务有关的信息,不能构成从 TI 获得使用这些产品或服务的许可、授权、或认可。使用此类信息可能需要获得第三方的专利权或其它知识产权方面的许可,或是 TI 的专利权或其它知识产权方面的许可。

对于 TI 的产品手册或数据表中 TI 信息的重要部分,仅在没有对内容进行任何篡改且带有相关授权、条件、限制和声明的情况下才允许进行复制。TI 对此类篡改过的文件不承担任何责任或义务。复制第三方的信息可能需要服从额外的限制条件。

在转售 TI 组件或服务时,如果对该组件或服务参数的陈述与 TI 标明的参数相比存在差异或虚假成分,则会失去相关 TI 组件或服务的所有明示或暗示授权,且这是不正当的、欺诈性商业行为。TI 对任何此类虚假陈述均不承担任何责任或义务。

客户认可并同意,尽管任何应用相关信息或支持仍可能由 TI 提供,但他们将独立负责满足与其产品及其在应用中使用的 TI 产品相关的所有法律、法规和安全相关要求。客户声明并同意,他们具备制定与实施安全措施所需的全部专业技术和知识,可预见故障的危险后果、监测故障及其后果、降低有可能造成人身伤害的故障的发生机率并采取适当的补救措施。客户将全额赔偿因在此类安全关键应用中使用任何 TI 组件而对 TI 及其代理造成的任何损失。

在某些场合中,为了推进安全相关应用有可能对 TI 组件进行特别的促销。TI 的目标是利用此类组件帮助客户设计和创立其特有的可满足适用的功能安全性标准和要求的终端产品解决方案。尽管如此,此类组件仍然服从这些条款。

TI 组件未获得用于 FDA Class III (或类似的生命攸关医疗设备)的授权许可,除非各方授权官员已经达成了专门管控此类使用的特别协议。

只有那些 TI 特别注明属于军用等级或“增强型塑料”的 TI 组件才是设计或专门用于军事/航空应用或环境的。购买者认可并同意,对并非指定面向军事或航空航天用途的 TI 组件进行军事或航空航天方面的应用,其风险由客户单独承担,并且由客户独立负责满足与此类使用相关的所有法律和法规要求。

TI 已明确指定符合 ISO/TS16949 要求的产品,这些产品主要用于汽车。在任何情况下,因使用非指定产品而无法达到 ISO/TS16949 要求, TI 不承担任何责任。

	产品		应用
数字音频	<a href="http://www.ti.com.cn/audio">www.ti.com.cn/audio</a>	通信与电信	<a href="http://www.ti.com.cn/telecom">www.ti.com.cn/telecom</a>
放大器和线性器件	<a href="http://www.ti.com.cn/amplifiers">www.ti.com.cn/amplifiers</a>	计算机及周边	<a href="http://www.ti.com.cn/computer">www.ti.com.cn/computer</a>
数据转换器	<a href="http://www.ti.com.cn/dataconverters">www.ti.com.cn/dataconverters</a>	消费电子	<a href="http://www.ti.com.cn/consumer-apps">www.ti.com.cn/consumer-apps</a>
DLP® 产品	<a href="http://www.dlp.com">www.dlp.com</a>	能源	<a href="http://www.ti.com.cn/energy">www.ti.com.cn/energy</a>
DSP - 数字信号处理器	<a href="http://www.ti.com.cn/dsp">www.ti.com.cn/dsp</a>	工业应用	<a href="http://www.ti.com.cn/industrial">www.ti.com.cn/industrial</a>
时钟和计时器	<a href="http://www.ti.com.cn/clockandtimers">www.ti.com.cn/clockandtimers</a>	医疗电子	<a href="http://www.ti.com.cn/medical">www.ti.com.cn/medical</a>
接口	<a href="http://www.ti.com.cn/interface">www.ti.com.cn/interface</a>	安防应用	<a href="http://www.ti.com.cn/security">www.ti.com.cn/security</a>
逻辑	<a href="http://www.ti.com.cn/logic">www.ti.com.cn/logic</a>	汽车电子	<a href="http://www.ti.com.cn/automotive">www.ti.com.cn/automotive</a>
电源管理	<a href="http://www.ti.com.cn/power">www.ti.com.cn/power</a>	视频和影像	<a href="http://www.ti.com.cn/video">www.ti.com.cn/video</a>
微控制器 (MCU)	<a href="http://www.ti.com.cn/microcontrollers">www.ti.com.cn/microcontrollers</a>		
RFID 系统	<a href="http://www.ti.com.cn/rfidsys">www.ti.com.cn/rfidsys</a>		
OMAP应用处理器	<a href="http://www.ti.com/omap">www.ti.com/omap</a>		
无线连通性	<a href="http://www.ti.com.cn/wirelessconnectivity">www.ti.com.cn/wirelessconnectivity</a>	德州仪器在线技术支持社区	<a href="http://www.deyisupport.com">www.deyisupport.com</a>

邮寄地址: 上海市浦东新区世纪大道1568号, 中建大厦32楼邮政编码: 200122  
Copyright © 2015, 德州仪器半导体技术(上海)有限公司

## PACKAGING INFORMATION

Orderable Device	Status (1)	Package Type	Package Drawing	Pins	Package Qty	Eco Plan (2)	Lead/Ball Finish (6)	MSL Peak Temp (3)	Op Temp (°C)	Device Marking (4/5)	Samples
TPS62740DSSR	ACTIVE	WSON	DSS	12	3000	Green (RoHS & no Sb/Br)	CU NIPDAU	Level-2-260C-1 YEAR	-40 to 85	62740	<a href="#">Samples</a>
TPS62740DSST	ACTIVE	WSON	DSS	12	250	Green (RoHS & no Sb/Br)	CU NIPDAU	Level-2-260C-1 YEAR	-40 to 85	62740	<a href="#">Samples</a>
TPS62742DSSR	ACTIVE	WSON	DSS	12	3000	Green (RoHS & no Sb/Br)	CU NIPDAU	Level-2-260C-1 YEAR	-40 to 85	62742	<a href="#">Samples</a>
TPS62742DSST	ACTIVE	WSON	DSS	12	250	Green (RoHS & no Sb/Br)	CU NIPDAU	Level-2-260C-1 YEAR	-40 to 85	62742	<a href="#">Samples</a>

(1) The marketing status values are defined as follows:

**ACTIVE:** Product device recommended for new designs.

**LIFEBUY:** TI has announced that the device will be discontinued, and a lifetime-buy period is in effect.

**NRND:** Not recommended for new designs. Device is in production to support existing customers, but TI does not recommend using this part in a new design.

**PREVIEW:** Device has been announced but is not in production. Samples may or may not be available.

**OBSOLETE:** TI has discontinued the production of the device.

(2) Eco Plan - The planned eco-friendly classification: Pb-Free (RoHS), Pb-Free (RoHS Exempt), or Green (RoHS & no Sb/Br) - please check <http://www.ti.com/productcontent> for the latest availability information and additional product content details.

**TBD:** The Pb-Free/Green conversion plan has not been defined.

**Pb-Free (RoHS):** TI's terms "Lead-Free" or "Pb-Free" mean semiconductor products that are compatible with the current RoHS requirements for all 6 substances, including the requirement that lead not exceed 0.1% by weight in homogeneous materials. Where designed to be soldered at high temperatures, TI Pb-Free products are suitable for use in specified lead-free processes.

**Pb-Free (RoHS Exempt):** This component has a RoHS exemption for either 1) lead-based flip-chip solder bumps used between the die and package, or 2) lead-based die adhesive used between the die and leadframe. The component is otherwise considered Pb-Free (RoHS compatible) as defined above.

**Green (RoHS & no Sb/Br):** TI defines "Green" to mean Pb-Free (RoHS compatible), and free of Bromine (Br) and Antimony (Sb) based flame retardants (Br or Sb do not exceed 0.1% by weight in homogeneous material)

(3) MSL, Peak Temp. - The Moisture Sensitivity Level rating according to the JEDEC industry standard classifications, and peak solder temperature.

(4) There may be additional marking, which relates to the logo, the lot trace code information, or the environmental category on the device.

(5) Multiple Device Markings will be inside parentheses. Only one Device Marking contained in parentheses and separated by a "~" will appear on a device. If a line is indented then it is a continuation of the previous line and the two combined represent the entire Device Marking for that device.

(6) Lead/Ball Finish - Orderable Devices may have multiple material finish options. Finish options are separated by a vertical ruled line. Lead/Ball Finish values may wrap to two lines if the finish value exceeds the maximum column width.

**Important Information and Disclaimer:** The information provided on this page represents TI's knowledge and belief as of the date that it is provided. TI bases its knowledge and belief on information provided by third parties, and makes no representation or warranty as to the accuracy of such information. Efforts are underway to better integrate information from third parties. TI has taken and continues to take reasonable steps to provide representative and accurate information but may not have conducted destructive testing or chemical analysis on incoming materials and chemicals. TI and TI suppliers consider certain information to be proprietary, and thus CAS numbers and other limited information may not be available for release.

In no event shall TI's liability arising out of such information exceed the total purchase price of the TI part(s) at issue in this document sold by TI to Customer on an annual basis.

**TAPE AND REEL INFORMATION**

**QUADRANT ASSIGNMENTS FOR PIN 1 ORIENTATION IN TAPE**



\*All dimensions are nominal

Device	Package Type	Package Drawing	Pins	SPQ	Reel Diameter (mm)	Reel Width W1 (mm)	A0 (mm)	B0 (mm)	K0 (mm)	P1 (mm)	W (mm)	Pin1 Quadrant
TPS62740DSSR	WSON	DSS	12	3000	180.0	8.4	2.25	3.25	1.05	4.0	8.0	Q1
TPS62740DSST	WSON	DSS	12	250	180.0	8.4	2.25	3.25	1.05	4.0	8.0	Q1
TPS62742DSSR	WSON	DSS	12	3000	180.0	8.4	2.25	3.25	1.05	4.0	8.0	Q1
TPS62742DSST	WSON	DSS	12	250	180.0	8.4	2.25	3.25	1.05	4.0	8.0	Q1

**TAPE AND REEL BOX DIMENSIONS**

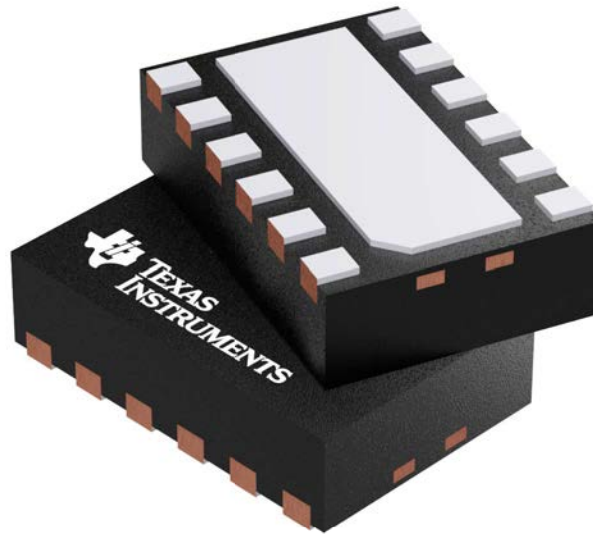

\*All dimensions are nominal

Device	Package Type	Package Drawing	Pins	SPQ	Length (mm)	Width (mm)	Height (mm)
TPS62740DSSR	WSON	DSS	12	3000	210.0	185.0	35.0
TPS62740DSST	WSON	DSS	12	250	210.0	185.0	35.0
TPS62742DSSR	WSON	DSS	12	3000	210.0	185.0	35.0
TPS62742DSST	WSON	DSS	12	250	210.0	185.0	35.0

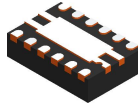

Images above are just a representation of the package family, actual package may vary.  
Refer to the product data sheet for package details.

# DSS0012A



## PACKAGE OUTLINE

WSON - 0.8 mm max height

PLASTIC SMALL OUTLINE - NO LEAD

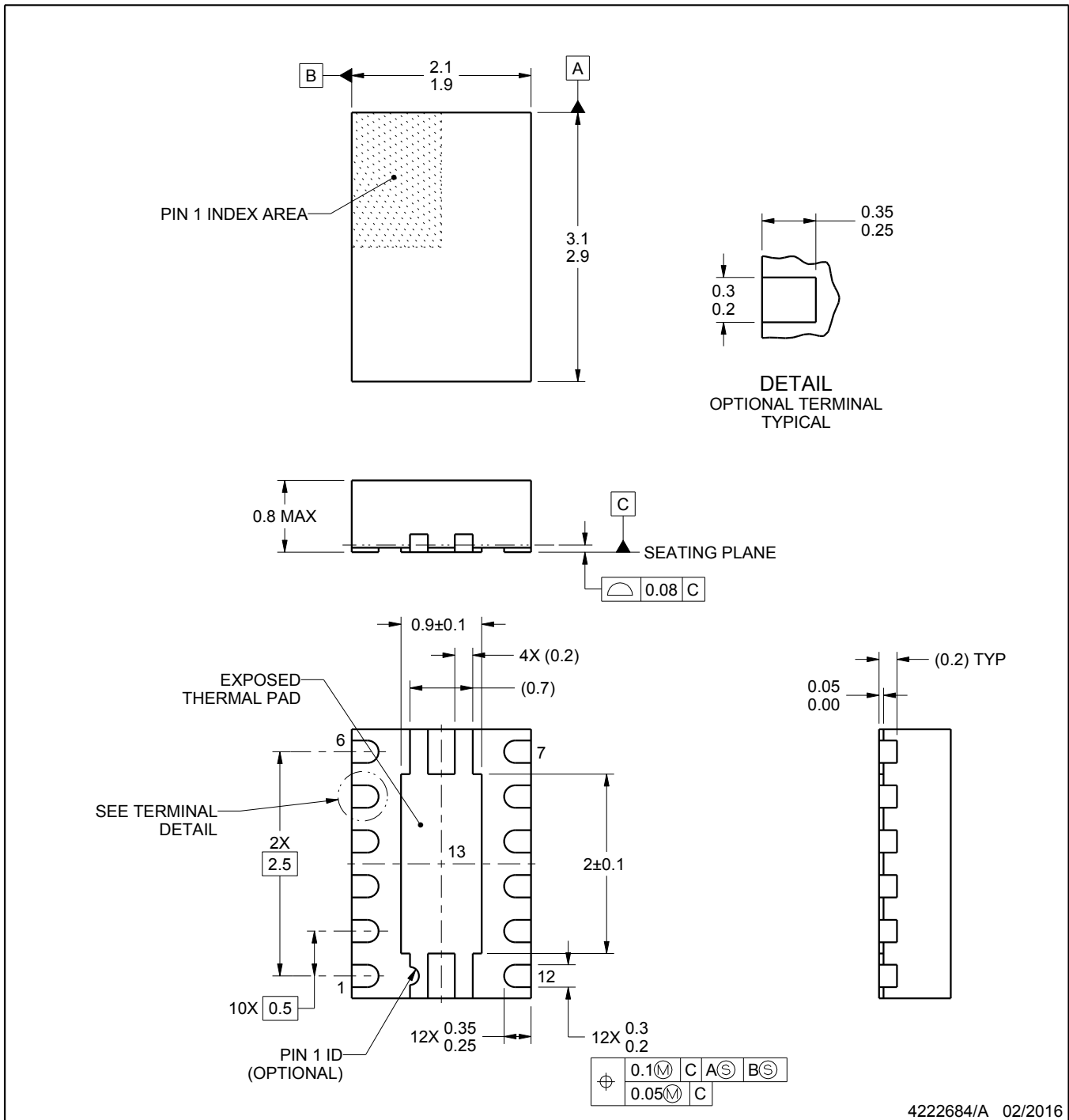

**NOTES:**

1. All linear dimensions are in millimeters. Any dimensions in parenthesis are for reference only. Dimensioning and tolerancing per ASME Y14.5M.
2. This drawing is subject to change without notice.
3. The package thermal pad must be soldered to the printed circuit board for thermal and mechanical performance.





# EXAMPLE STENCIL DESIGN

DSS0012A

WSON - 0.8 mm max height

PLASTIC SMALL OUTLINE - NO LEAD

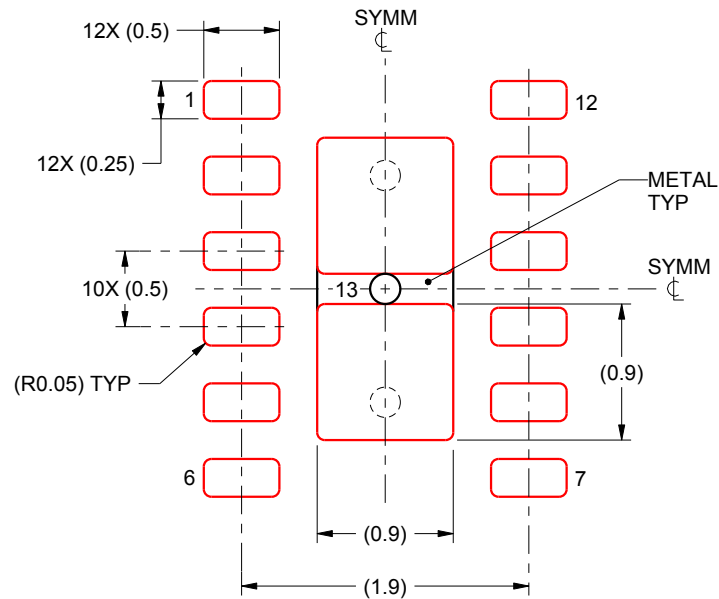

SOLDER PASTE EXAMPLE  
BASED ON 0.125 mm THICK STENCIL

EXPOSED PAD 13:  
90% PRINTED SOLDER COVERAGE BY AREA UNDER PACKAGE  
SCALE:20X

4222684/A 02/2016

NOTES: (continued)

6. Laser cutting apertures with trapezoidal walls and rounded corners may offer better paste release. IPC-7525 may have alternate design recommendations.

## 重要声明

德州仪器 (TI) 公司有权按照最新发布的 JESD46 对其半导体产品和服务进行纠正、增强、改进和其他修改，并不再按最新发布的 JESD48 提供任何产品和服务。买方在下订单前应获取最新的相关信息，并验证这些信息是否完整且是最新的。

TI 公布的半导体产品销售条款 (<http://www.ti.com/sc/docs/stdterms.htm>) 适用于 TI 已认证和批准上市的已封装集成电路产品的销售。另有其他条款可能适用于其他类型 TI 产品及服务的使用或销售。

复制 TI 数据表上 TI 信息的重要部分时，不得变更该等信息，且必须随附所有相关保证、条件、限制和通知，否则不得复制。TI 对该等复制文件不承担任何责任。第三方信息可能受到其它限制条件的制约。在转售 TI 产品或服务时，如果存在对产品或服务参数的虚假陈述，则会失去相关 TI 产品或服务的明示或暗示保证，且构成不公平的、欺诈性商业行为。TI 对此类虚假陈述不承担任何责任。

买方和在系统中整合 TI 产品的其他开发人员（总称“设计人员”）理解并同意，设计人员在设计应用时应自行实施独立的分析、评价和判断，且应全权负责并确保应用的安全性，及设计人员的应用（包括应用中使用的 TI 产品）应符合所有适用的法律法规及其他相关要求。设计人员就自己设计的应用声明，其具备制订和实施下列保障措施所需的一切必要专业知识，能够 (1) 预见故障的危险后果，(2) 监视故障及其后果，以及 (3) 降低可能导致危险的故障几率并采取适当措施。设计人员同意，在使用或分发包含 TI 产品的任何应用前，将彻底测试该等应用和该等应用中所用 TI 产品的功能。

TI 提供技术、应用或其他设计建议、质量特点、可靠性数据或其他服务或信息，包括但不限于与评估模块有关的参考设计和材料（总称“TI 资源”），旨在帮助设计人员开发整合了 TI 产品的应用，如果设计人员（个人，或如果是代表公司，则为设计人员的公司）以任何方式下载、访问或使用任何特定的 TI 资源，即表示其同意仅为该等目标，按照本通知的条款使用任何特定 TI 资源。

TI 所提供的 TI 资源，并未扩大或以其他方式修改 TI 对 TI 产品的公开适用的质保及质保免责声明；也未导致 TI 承担任何额外的义务或责任。TI 有权对其 TI 资源进行纠正、增强、改进和其他修改。除特定 TI 资源的公开文档中明确列出的测试外，TI 未进行任何其他测试。

设计人员只有在开发包含该等 TI 资源所列 TI 产品的应用时，才被授权使用、复制和修改任何相关 TI 资源。但并未依据禁止反言原则或其他法律授予您任何 TI 知识产权的任何其他明示或默示的许可，也未授予您 TI 或第三方的任何技术或知识产权的许可，该等许可包括但不限于任何专利权、版权、屏蔽作品权或与美国 TI 产品或服务的任何整合、机器制作、流程相关的其他知识产权。涉及或参考了第三方产品或服务的信息不构成使用此类产品或服务的许可或与其相关的保证或认可。使用 TI 资源可能需要您向第三方获得对该等第三方专利或其他知识产权的许可。

TI 资源系“按原样”提供。TI 兹免除对资源及其使用作出所有其他明确或默示的保证或陈述，包括但不限于对准确性或完整性、产权保证、无屡发故障保证，以及适销性、适合特定用途和不侵犯任何第三方知识产权的任何默认保证。TI 不负责任何申索，包括但不限于因组合产品所致或与之有关的申索，也不为或对设计人员进行辩护或赔偿，即使该等产品组合已列于 TI 资源或其他地方。对因 TI 资源或其使用引起或与之有关的任何实际的、直接的、特殊的、附带的、间接的、惩罚性的、偶发的、从属或惩戒性损害赔偿，不管 TI 是否获悉可能会产生上述损害赔偿，TI 概不负责。

除 TI 已明确指出特定产品已达到特定行业标准（例如 ISO/TS 16949 和 ISO 26262）的要求外，TI 不对未达到任何该等行业标准要求而承担任何责任。

如果 TI 明确宣称产品有助于功能安全或符合行业功能安全标准，则该等产品旨在帮助客户设计和创作自己的符合相关功能安全标准和要求的的应用。在应用内使用产品的行为本身不会配有安全特性。设计人员必须确保遵守适用于其应用的相关安全要求和标准。设计人员不可将任何 TI 产品用于关乎性命的医疗设备，除非已由各方获得授权的管理人员签署专门的合同对此类应用专门作出规定。关乎性命的医疗设备是指出现故障会导致严重身体伤害或死亡的医疗设备（例如生命保障设备、心脏起搏器、心脏除颤器、人工心脏泵、神经刺激器以及植入设备）。此类设备包括但不限于，美国食品药品监督管理局认定为 III 类设备的设备，以及在美国以外的其他国家或地区认定为同等类别设备的所有医疗设备。

TI 可能明确指定某些产品具备某些特定资格（例如 Q100、军用级或增强型产品）。设计人员同意，其具备一切必要专业知识，可以为自己的应用选择适合的产品，并且正确选择产品的风险由设计人员承担。设计人员单方面负责遵守与该等选择有关的所有法律或监管要求。

设计人员同意向 TI 及其代表全额赔偿因其不遵守本通知条款和条件而引起的任何损害、费用、损失和/或责任。

邮寄地址：上海市浦东新区世纪大道 1568 号中建大厦 32 楼，邮政编码：200122  
Copyright © 2017 德州仪器半导体技术（上海）有限公司