

## Very low drop and low noise BiCMOS 300 mA voltage regulator

Datasheet - production data

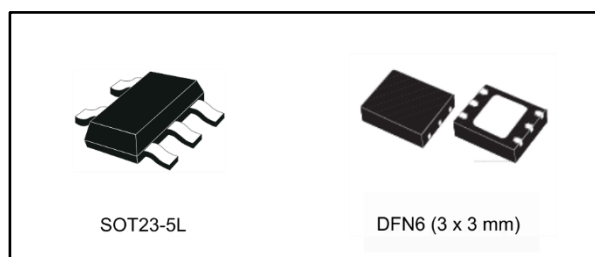

- Logic-controlled electronic shutdown
- Internal current and thermal limit
- Low output voltage noise: 30  $\mu$  V<sub>RMS</sub> over 10 Hz to 100 kHz
- SVR of 55 dB at 1 kHz, 50 dB at 10 kHz
- Temperature range: - 40 °C to 125 °C
- Automotive grade product available in DFN6 package, temperature range: - 40 °C to 85 °C

### Features

- Input voltage from 2.5 V to 6 V
- Stable with low ESR ceramic capacitors
- Very low dropout voltage (150 mV typ. at 300 mA load, 0.4 mV typ. at 1 mA load)
- Very low quiescent current (85  $\mu$ A typ. at no load, 200  $\mu$ A typ. at 300 mA load; max. 1.5  $\mu$ A in OFF mode)
- Guaranteed output current up to 300 mA
- Wide range of output voltages available on request: fixed from 1.25 V to 5 V with 100 mV step
- Fast turn-on time: typ. 240  $\mu$ s
  - [C<sub>O</sub> = 2.2  $\mu$ F, C<sub>BYP</sub> = 33 nF and I<sub>O</sub> = 1 mA]

### Description

The LDS3985 provides up to 300 mA, from 2.5 V to 6 V input voltage. It is stable with ceramic and high quality tantalum capacitor. The ultra low drop voltage, low quiescent current and low noise make it suitable for low power applications and battery-powered systems. Shutdown logic control function is available, this means that when the device is used as local regulator, it is possible to put a part of the board in standby, decreasing the total power consumption. Typical applications are mobile phones and similar battery-powered wireless systems, portable information appliances.

Table 1: Device summary

Packages			Output voltage (V)
SOT23-5L	DFN6 (3 x 3 mm)	DFN6 (3 x 3 mm) automotive-grade	
LDS3985M15R	LDS3985PU15R		1.5
LDS3985M18R		LDS3985PU18RY <sup>(1)</sup>	1.8
LDS3985M25R			2.5
LDS3985M28R	LDS3985PU28R		2.8
LDS3985M30R			3.0
LDS3985M33R	LDS3985PU33R	LDS3985PU33RY <sup>(1)</sup>	3.3
LDS3985M50R			5.0

#### Notes:

<sup>(1)</sup>Qualified and characterized according to AEC Q100 and Q003 or equivalent, advanced screening according to AEC Q001 and Q002 or equivalent.

---

# Contents

<b>1</b>	<b>Diagram</b> .....	<b>3</b>
<b>2</b>	<b>Pin configuration</b> .....	<b>4</b>
<b>3</b>	<b>Maximum ratings</b> .....	<b>5</b>
<b>4</b>	<b>Electrical characteristics</b> .....	<b>6</b>
<b>5</b>	<b>Typical performance characteristics</b> .....	<b>10</b>
<b>6</b>	<b>Package information</b> .....	<b>13</b>
6.1	SOT23-5L package information .....	13
6.2	SOT23-5L packing information.....	15
6.3	DFN6 (3 x 3 mm) package information .....	16
6.4	DFN6 (3 x 3 mm) packing information.....	18
<b>7</b>	<b>Revision history</b> .....	<b>20</b>

# 1 Diagram

Figure 1: Schematic diagram

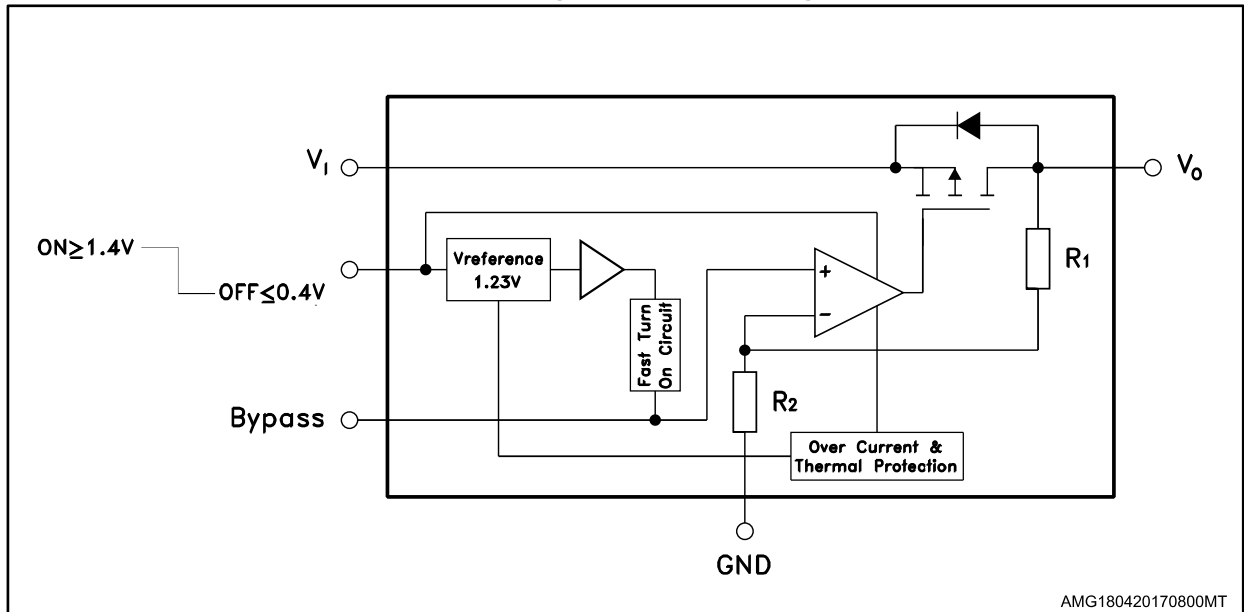

## 2 Pin configuration

Figure 2: Pin connections (top view for SOT23-5L, and for DFN6 (3 x 3 mm))

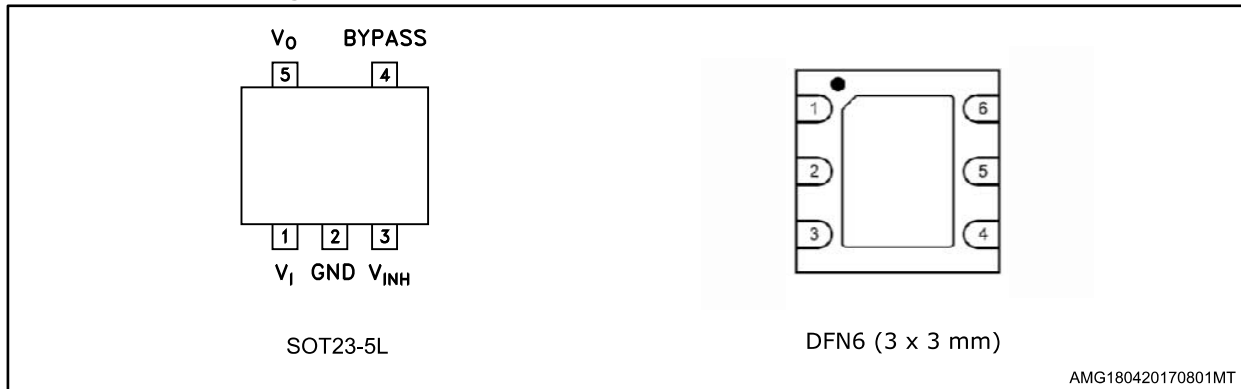

Table 2: Pin description

Pin for SOT23-5L	Pin for DFN6 (3 x 3 mm)	Symbol	Name and function
1	1	$V_I$	LDO input voltage
2	5	GND	Common ground
3	6	$V_{INH}$	Inhibit input voltage: ON mode when $V_{INH} \geq 1.2$ V, OFF mode when $V_{INH} \leq 0.4$ V (do not leave it floating; it is not internally pulled down/up)
4	4	Bypass	Bypass pin: an external capacitor to be connected (usually 10 nF) to minimize noise voltage
5	3	$V_O$	LDO output voltage
-	2	N.C.	Not connected

### 3 Maximum ratings

Table 3: Absolute maximum ratings

Symbol	Parameter	Value	Unit
$V_I$	DC input voltage	-0.3 to 6 <sup>(1)</sup>	V
$V_O$	DC output voltage	-0.3 to $V_I + 0.3$	V
$V_{INH}$	Inhibit input voltage	-0.3 to $V_I + 0.3$	V
$I_O$	Output current	Internally limited	
$P_D$	Power dissipation	Internally limited	
$T_{STG}$	Storage temperature range	-65 to 150	°C
$T_{OP}$	Operating junction temperature range	-40 to 125	°C
	Operating junction temperature range, automotive grade version	- 40 to 85	°C

**Notes:**

<sup>(1)</sup>The input pin is able to withstand non repetitive spike of 6.5 V for 200 ms.



Absolute maximum ratings are those values beyond which damage to the device may occur. Functional operation under these condition is not implied.

Table 4: Thermal data

Symbol	Parameter	SOT23-5L	DFN6 (3 x 3 mm)	Unit
$R_{thJC}$	Thermal resistance junction-case	81	10	°C/W
$R_{thJA}$	Thermal resistance junction-ambient	255	55	°C/W

## 4 Electrical characteristics

$T_J = 25\text{ °C}$ ,  $V_I = V_{O(NOM)} + 0.5\text{ V}$ ,  $C_I = 1\text{ }\mu\text{F}$ ,  $C_O = 2.2\text{ }\mu\text{F}$ ,  $C_{BYP} = 33\text{ nF}$ ,  $I_O = 1\text{ mA}$ ,  
 $V_{INH} = 1.4\text{ V}$ , unless otherwise specified.

Table 5: LDS3985 electrical characteristics

Symbol	Parameter	Test condition	Min.	Typ.	Max.	Unit
$V_I$	Operating input voltage		2.5		6	V
$V_O$	Output voltage < 2.5 V	$I_O = 1\text{ mA}$	-50		50	mV
		$T_J = -40\text{ to }125\text{ °C}$	-75		75	
$V_O$	Output voltage $\geq 2.5\text{ V}$	$I_O = 1\text{ mA}$	-2		2	%
		$T_J = -40\text{ to }125\text{ °C}$	-3		3	
$\Delta V_O$	Line regulation <sup>(1)</sup>	$V_I = V_{O(NOM)} + 0.5\text{ to }6\text{ V}$ , $T_J = -40\text{ to }125\text{ °C}$	-0.1		0.1	%/ $V$
		$V_O = 4.7\text{ to }5\text{ V}$	-0.19		0.19	
$\Delta V_O$	Load regulation	$I_O = 1\text{ mA to }300\text{ mA}$ , $V_O \leq 2.5\text{ V}$ $T_J = -40\text{ to }125\text{ °C}$		0.005	0.01	%/mA
$\Delta V_O$	Load regulation	$I_O = 1\text{ mA to }300\text{ mA}$ , $V_O \geq 2.5\text{ V}$ $T_J = -40\text{ to }125\text{ °C}$		0.0008	0.004	%/mA
$\Delta V_O$	Output AC line regulation <sup>(2)</sup>	$V_I = V_{O(NOM)} + 1\text{ V}$ , $I_O = 300\text{ mA}$ , $t_R = t_F = 30\text{ }\mu\text{s}$		5		mV <sub>PP</sub>
$I_Q$	Quiescent current ON mode: $V_{INH} = 1.4\text{ V}$	$I_O = 0$		85		$\mu\text{A}$
		$I_O = 0$ , $T_J = -40\text{ to }125\text{ °C}$			150	
		$I_O = 0\text{ to }300\text{ mA}$		200		
		$I_O = 0\text{ to }300\text{ mA}$ , $T_J = -40\text{ to }125\text{ °C}$			300	
	OFF mode: $V_{INH} = 0.4\text{ V}$	$T_J = -40\text{ to }125\text{ °C}$		0.003	1.5	
$V_{DROP}$	Dropout voltage <sup>(3)</sup>	$I_O = 1\text{ mA}$		0.4		mV
		$I_O = 1\text{ mA}$ , $T_J = -40\text{ to }125\text{ °C}$			2	
		$I_O = 150\text{ mA}$		60		
		$I_O = 150\text{ mA}$ , $T_J = -40\text{ to }125\text{ °C}$			100	
		$I_O = 300\text{ mA}$		150		
		$I_O = 300\text{ mA}$ , $T_J = -40\text{ to }125\text{ °C}$			250	

Symbol	Parameter	Test condition	Min.	Typ.	Max.	Unit	
I <sub>SC</sub>	Short-circuit current	R <sub>L</sub> = 0		600		mA	
SVR	Supply voltage rejection	V <sub>I</sub> = V <sub>O(NOM)</sub> + 0.25 V ± V <sub>RIPPLE</sub> = 0.1 V, I <sub>O</sub> = 50 mA For V <sub>O(NOM)</sub> < 2.5 V, V <sub>I</sub> = 2.55 V	f = 1 kHz		55		dB
			f = 10 kHz		50		
I <sub>O(PK)</sub>	Peak output current	V <sub>O</sub> ≥ V <sub>O(NOM)</sub> - 5%	300	550		mA	
V <sub>INH</sub>	Inhibit input logic low	V <sub>I</sub> = 2.5 V to 6 V, T <sub>J</sub> = -40 to 125 °C			0.4	V	
	Inhibit input logic high		1.4				
I <sub>INH</sub>	Inhibit input current	V <sub>INH</sub> = 0.4 V, V <sub>I</sub> = 6 V		±1		nA	
eN	Output noise voltage	B <sub>W</sub> = 10 Hz to 100 kHz, C <sub>O</sub> = 2.2 μF		30		μV <sub>RMS</sub>	
t <sub>ON</sub>	Turn-on time <sup>(4)</sup>	C <sub>BYP</sub> = 33 nF		240		μs	
T <sub>SHDN</sub>	Thermal shutdown	<sup>(5)</sup>		160		°C	
C <sub>O</sub>	Output capacitor	Capacitance	2.2		22	μF	
		ESR	5		5000	mΩ	

**Notes:**

<sup>(1)</sup>For V<sub>O(NOM)</sub> < 2 V, V<sub>I</sub> = 2.5 V.

<sup>(2)</sup>For V<sub>O(NOM)</sub> = 1.25 V, V<sub>I</sub> = 2.5 V.

<sup>(3)</sup>Dropout voltage is the input-to-output voltage difference at which the output voltage is 100 mV below its nominal value. This specification does not apply to input voltages below 2.5 V.

<sup>(4)</sup>Turn-on time is time measured between the enable input just exceeding V<sub>INH</sub> high value and the output voltage just reaching 95% of its nominal value.

<sup>(5)</sup>Typical thermal protection hysteresis is 20 °C.

Table 6: LDS3985 (automotive grade) electrical characteristics

Symbol	Parameter	Test condition	Min.	Typ.	Max.	Unit
$V_I$	Operating input voltage		2.5		6	V
$V_O$	Output voltage < 2.5 V	$I_O = 1 \text{ mA}$	-50		50	mV
		$T_J = -40 \text{ to } 85 \text{ }^\circ\text{C}$	-75		75	
$V_O$	Output voltage $\geq 2.5 \text{ V}$	$I_O = 1 \text{ mA}$	-2		2	%
		$T_J = -40 \text{ to } 85 \text{ }^\circ\text{C}$	-3		3	
$\Delta V_O$	Line regulation <sup>(1)</sup>	$V_I = V_{O(NOM)} + 0.5 \text{ to } 6 \text{ V}$ , $T_J = -40 \text{ to } 85 \text{ }^\circ\text{C}$	-0.1		0.1	%/ $V$
		$V_O = 4.7 \text{ to } 5 \text{ V}$	-0.19		0.19	
$\Delta V_O$	Load regulation	$I_O = 1 \text{ mA to } 300 \text{ mA}$ , $V_O \leq 2.5 \text{ V}$ $T_J = -40 \text{ to } 85 \text{ }^\circ\text{C}$		0.005	0.01	%/ $\text{mA}$
$\Delta V_O$	Load regulation	$I_O = 1 \text{ mA to } 300 \text{ mA}$ , $V_O \geq 2.5 \text{ V}$ $T_J = -40 \text{ to } 85 \text{ }^\circ\text{C}$		0.0008	0.004	%/ $\text{mA}$
$\Delta V_O$	Output AC line regulation <sup>(2)</sup>	$V_I = V_{O(NOM)} + 1 \text{ V}$ , $I_O = 300 \text{ mA}$ $t_R = t_F = 30 \text{ } \mu\text{s}$		5		$\text{mV}_{PP}$
$I_Q$	Quiescent current ON mode: $V_{INH} = 1.4 \text{ V}$	$I_O = 0$		85		$\mu\text{A}$
		$I_O = 0$ , $T_J = -40 \text{ to } 85 \text{ }^\circ\text{C}$			150	
		$I_O = 0 \text{ to } 300 \text{ mA}$		200		
		$I_O = 0 \text{ to } 300 \text{ mA}$ , $T_J = -40 \text{ to } 85 \text{ }^\circ\text{C}$			300	
	OFF mode: $V_{INH} = 0.4 \text{ V}$	$T_J = -40 \text{ to } 85 \text{ }^\circ\text{C}$		0.003		
$V_{DROP}$	Dropout voltage <sup>(3)</sup>	$I_O = 1 \text{ mA}$		0.4		mV
		$I_O = 1 \text{ mA}$ , $T_J = -40 \text{ to } 85 \text{ }^\circ\text{C}$			2	
		$I_O = 150 \text{ mA}$		60		
		$I_O = 150 \text{ mA}$ , $T_J = -40 \text{ to } 85 \text{ }^\circ\text{C}$			100	
		$I_O = 300 \text{ mA}$		150		
		$I_O = 300 \text{ mA}$ , $T_J = -40 \text{ to } 85 \text{ }^\circ\text{C}$			250	
$I_{SC}$	Short-circuit current	$R_L = 0$		600		mA
SVR	Supply voltage rejection	$V_I = V_{O(NOM)} + 0.25 \text{ V} \pm V_{RIPPLE} = 0.1 \text{ V}$ , $I_O = 50 \text{ mA}$ For $V_{O(NOM)} < 2.5 \text{ V}$ $V_I = 2.55 \text{ V}$	$f = 1 \text{ kHz}$		55	dB
			$f = 10 \text{ kHz}$		50	



Symbol	Parameter	Test condition	Min.	Typ.	Max.	Unit
$I_{O(PK)}$	Peak output current	$V_O \geq V_{O(NOM)} - 5\%$	300	550		mA
$V_{INH}$	Inhibit input logic low	$V_I = 2.5 \text{ V to } 6 \text{ V},$ $T_J = -40 \text{ to } 85 \text{ }^\circ\text{C}$			0.4	V
	Inhibit input logic high		1.4			
$I_{INH}$	Inhibit input current	$V_{INH} = 0.4 \text{ V},$ $V_I = 6 \text{ V}$		$\pm 1$		nA
eN	Output noise voltage	$B_W = 10 \text{ Hz to } 100 \text{ kHz},$ $C_O = 2.2 \text{ } \mu\text{F}$		30		$\mu\text{V}_{RMS}$
$t_{ON}$	Turn-on time <sup>(4)</sup>	$C_{BYP} = 33 \text{ nF}$		240		$\mu\text{s}$
$T_{SHDN}$	Thermal shutdown	<sup>(5)</sup>		160		$^\circ\text{C}$
$C_O$	Output capacitor	Capacitance	2.2		22	$\mu\text{F}$
		ESR	5		5000	m $\Omega$

**Notes:**

<sup>(1)</sup>For  $V_{O(NOM)} < 2 \text{ V}$ ,  $V_I = 2.5 \text{ V}$ .

<sup>(2)</sup>For  $V_{O(NOM)} = 1.25 \text{ V}$ ,  $V_I = 2.5 \text{ V}$ .

<sup>(3)</sup>Dropout voltage is the input-to-output voltage difference at which the output voltage is 100 mV below its nominal value. This specification does not apply to input voltages below 2.5 V.

<sup>(4)</sup>Turn-on time is time measured between the enable input just exceeding  $V_{INH}$  high value and the output voltage just reaching 95% of its nominal value.

<sup>(5)</sup>Typical thermal protection hysteresis is 20  $^\circ\text{C}$ .

## 5 Typical performance characteristics

$T_J = 25\text{ }^\circ\text{C}$ ,  $V_I = V_{O(NOM)} + 0.5\text{ V}$ ,  $C_I = 1\text{ }\mu\text{F}$ ,  $C_O = 2.2\text{ }\mu\text{F}$ ,  $C_{BYP} = 33\text{ nF}$ ,  $I_O = 1\text{ mA}$ ,  $V_{INH} = 1.4\text{ V}$ , unless otherwise specified.

Figure 3: Output voltage vs temperature  $V_O = 1.35\text{ V}$

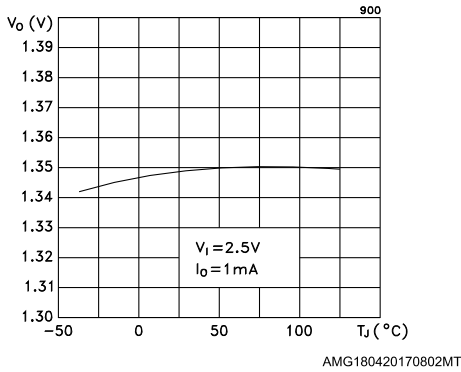

Figure 4: Output voltage vs temperature  $V_O = 2.8\text{ V}$

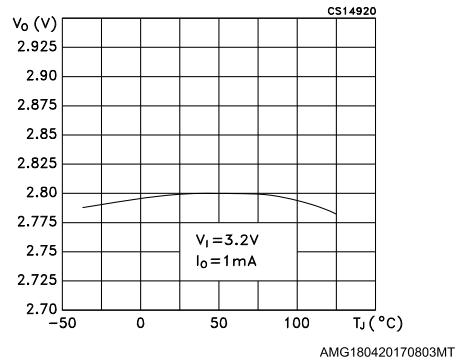

Figure 5: Output voltage vs temperature  $V_O = 3.3\text{ V}$

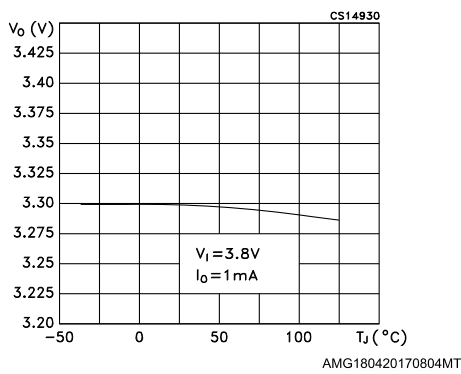

Figure 6: Inhibit voltage vs temperature  $V_O = 1.35\text{ V}$

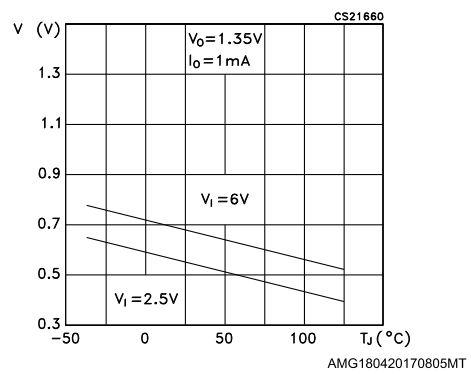

Figure 7: Inhibit voltage vs temperature ( $V_O = 3.3\text{ V}$ )

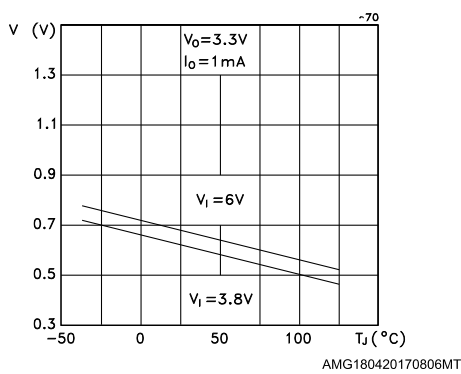
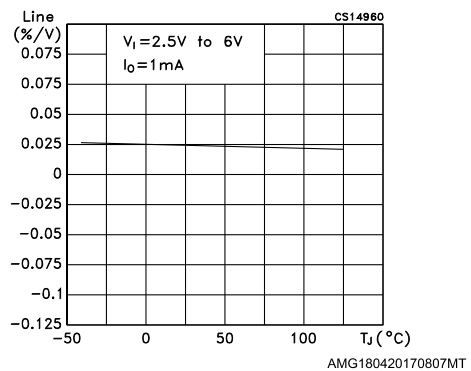
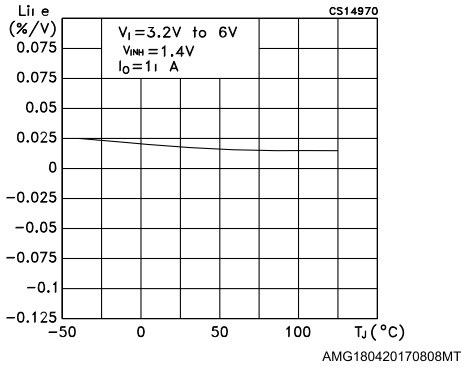

Figure 8: Line regulation vs temperature ( $V_I = 2.5\text{ V to }6\text{ V}$ )



**Figure 9: Line regulation vs temperature**  
( $V_I = 3.2\text{ V to }6\text{ V}$ )



**Figure 10: Line regulation vs temperature**  
( $V_I = 3.8\text{ V to }6\text{ V}$ )

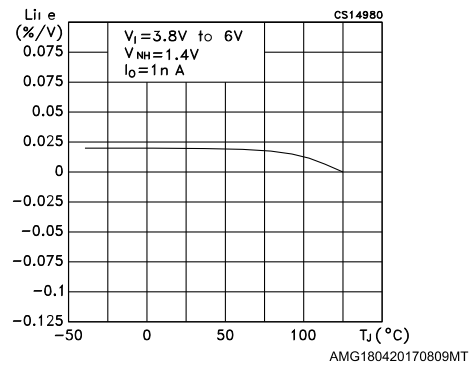

**Figure 11: Quiescent current vs temperature**  
( $V_I = 2.5\text{ V}$ )

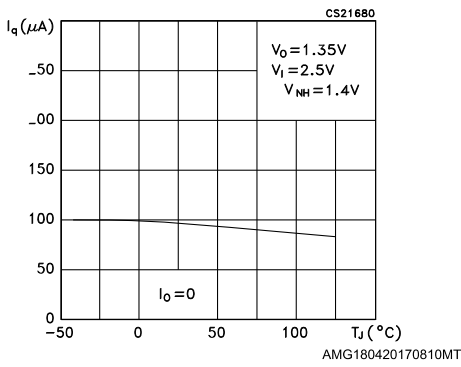

**Figure 12: Quiescent current vs temperature**  
( $V_I = 6\text{ V}$ )

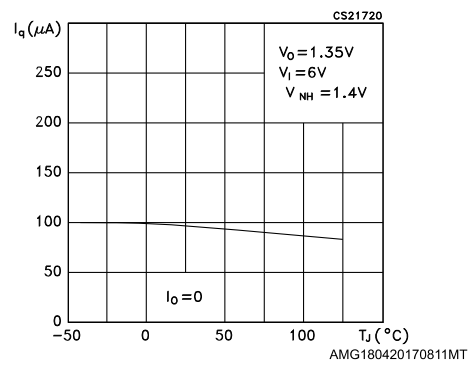

**Figure 13: Quiescent current vs temperature**  
( $V_I = 3.4\text{ V}$ )

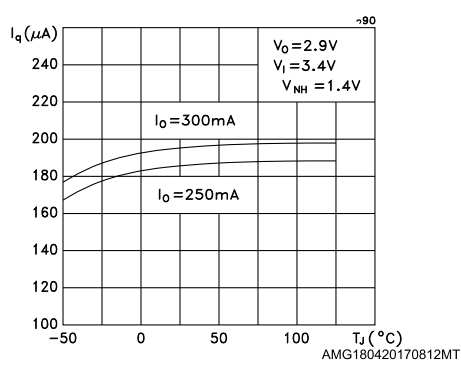

**Figure 14: Supply voltage rejection vs frequency**

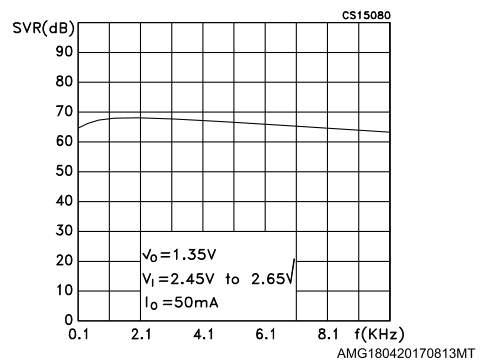

Figure 15: Dropout voltage vs temperature

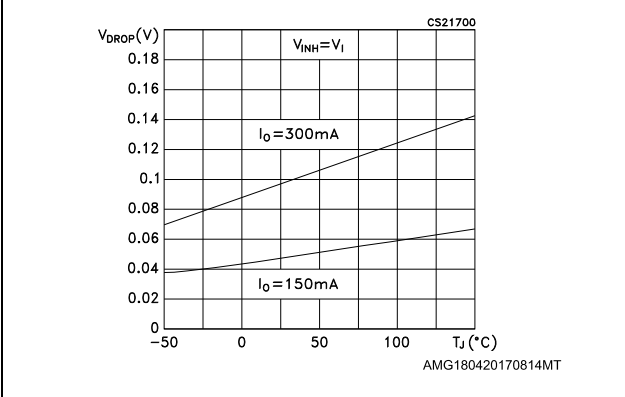

Figure 16: Dropout voltage vs output current

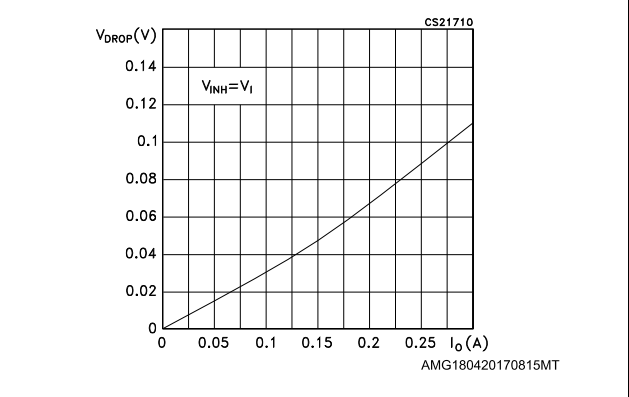
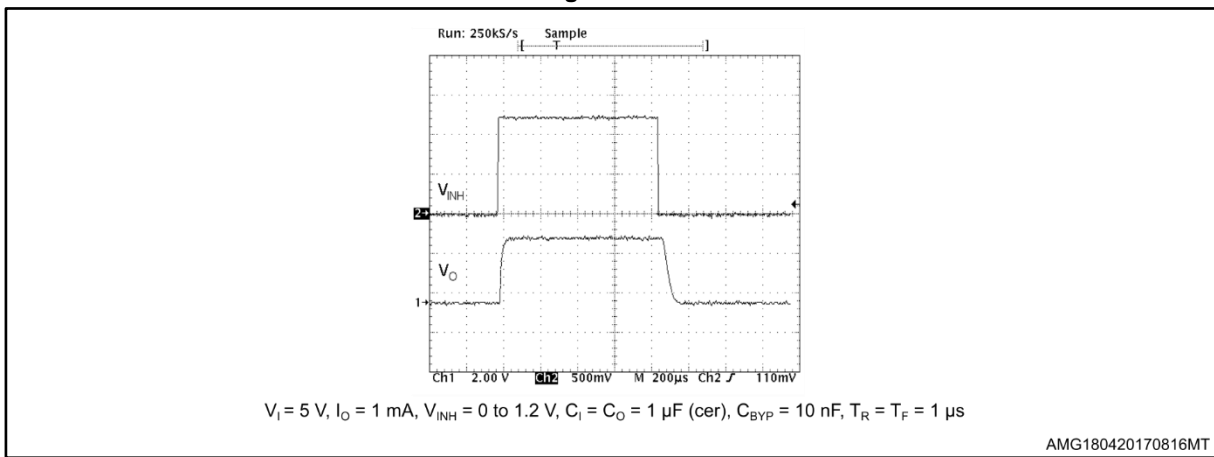

Figure 17: Inhibit transient



## 6 Package information

In order to meet environmental requirements, ST offers these devices in different grades of ECOPACK® packages, depending on their level of environmental compliance. ECOPACK® specifications, grade definitions and product status are available at: [www.st.com](http://www.st.com). ECOPACK® is an ST trademark.

### 6.1 SOT23-5L package information

Figure 18: SOT23-5L package outline

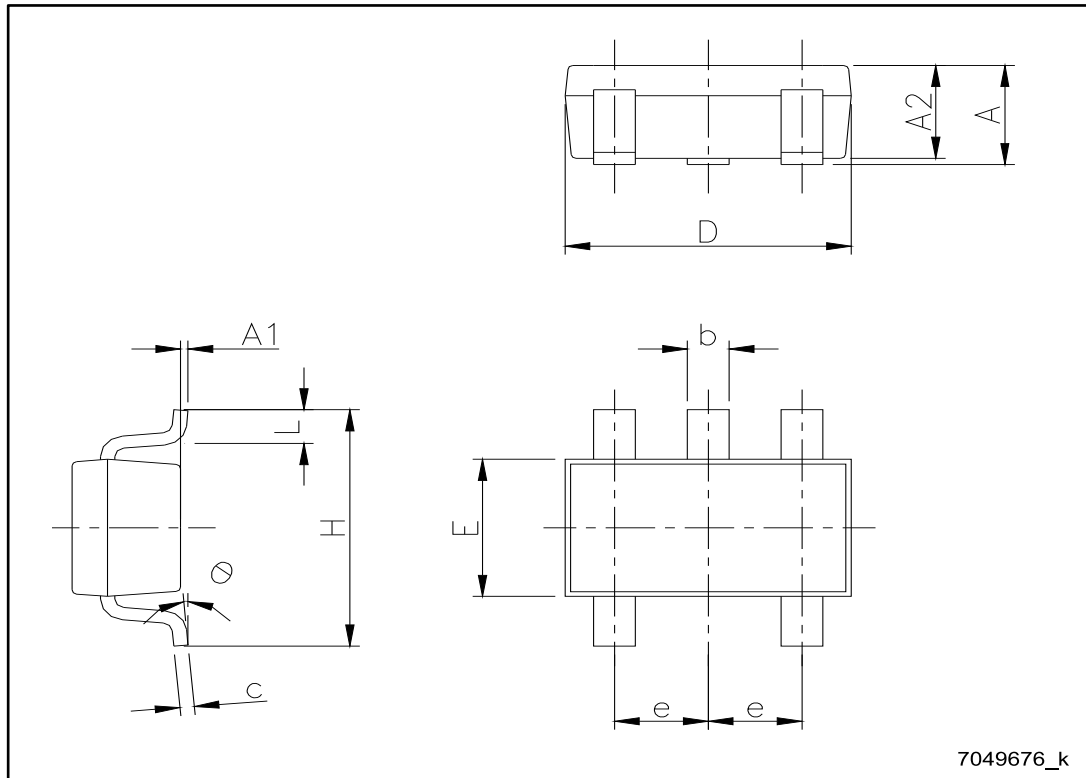
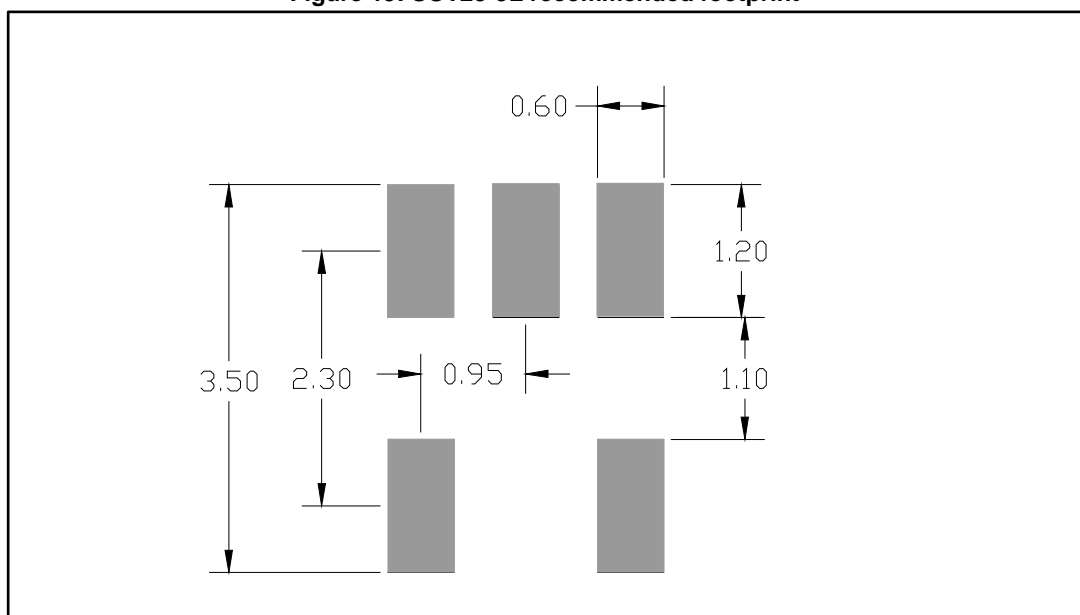

Table 7: SOT23-5L package mechanical data

Dim.	mm		
	Min.	Typ.	Max.
A	0.90		1.45
A1	0		0.15
A2	0.90		1.30
b	0.30		0.50
c	0.09		0.20
D		2.95	
E		1.60	
e		0.95	
H		2.80	
L	0.30		0.60
$\theta$	0°		8°

Figure 19: SOT23-5L recommended footprint



Dimensions are in mm

## 6.2 SOT23-5L packing information

Figure 20: SOT23-5L tape and reel outline

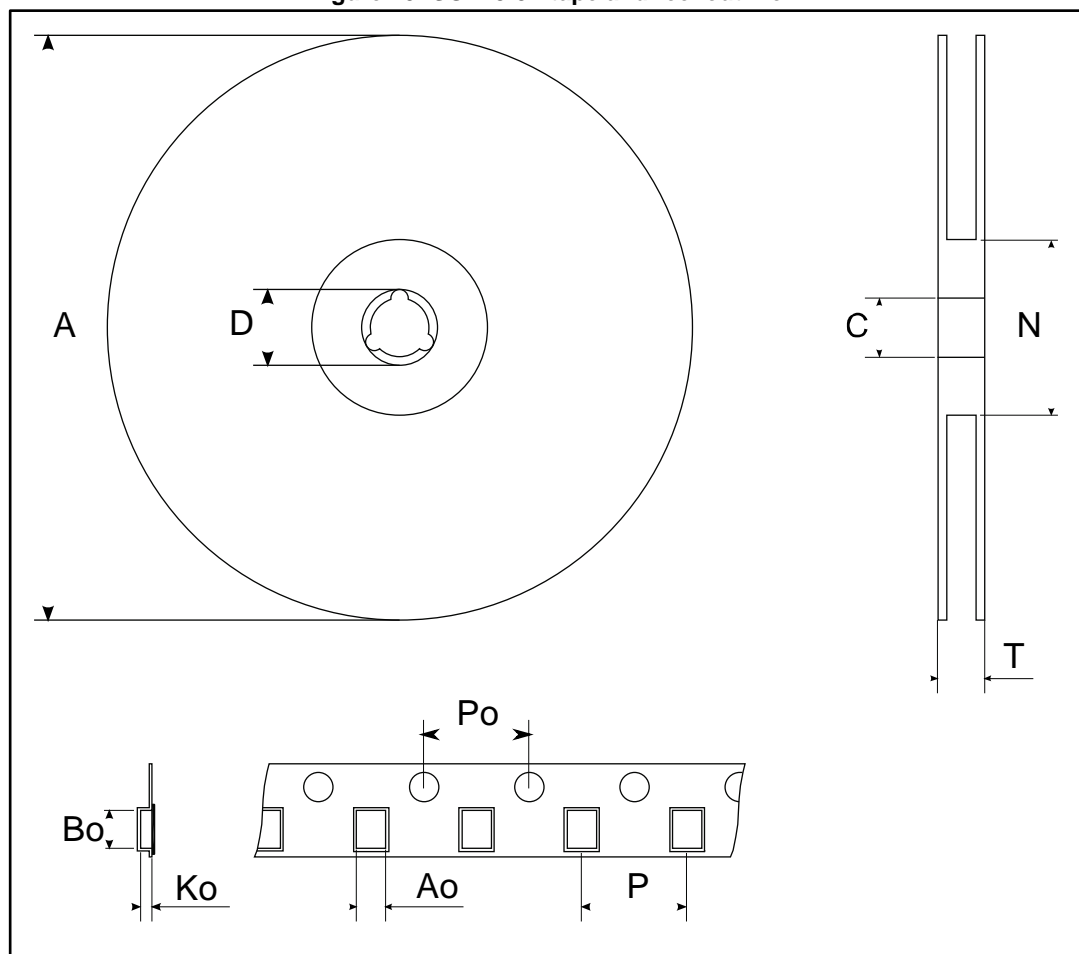

Table 8: SOT23-5L tape and reel mechanical data

Dim.	mm		
	Min.	Typ.	Max.
A			180
C	12.8	13.0	13.2
D	20.2		
N	60		
T			14.4
Ao	3.13	3.23	3.33
Bo	3.07	3.17	3.27
Ko	1.27	1.37	1.47
Po	3.9	4.0	4.1
P	3.9	4.0	4.1

### 6.3 DFN6 (3 x 3 mm) package information

Figure 21: DFN6 (3 x 3 mm) package outline

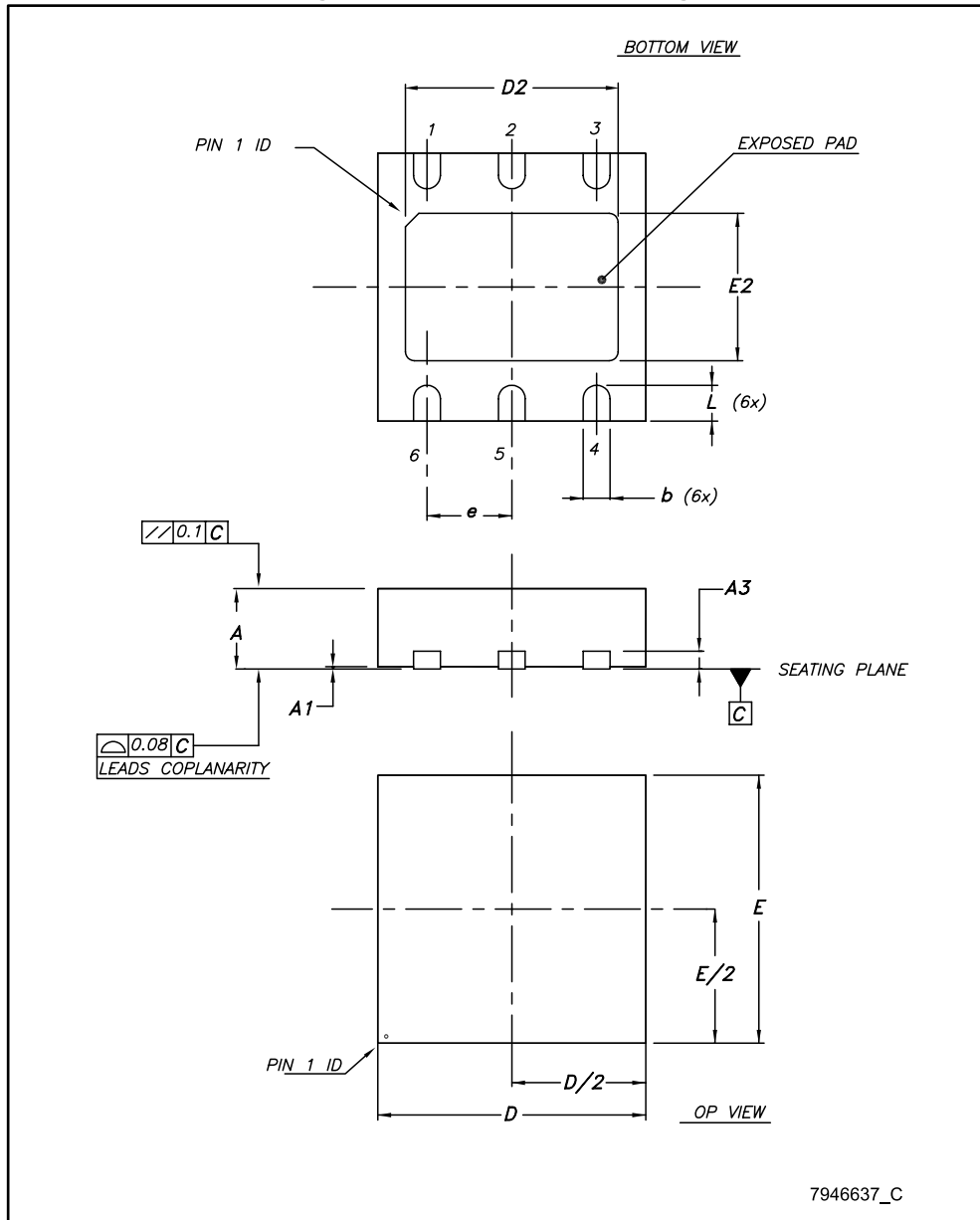
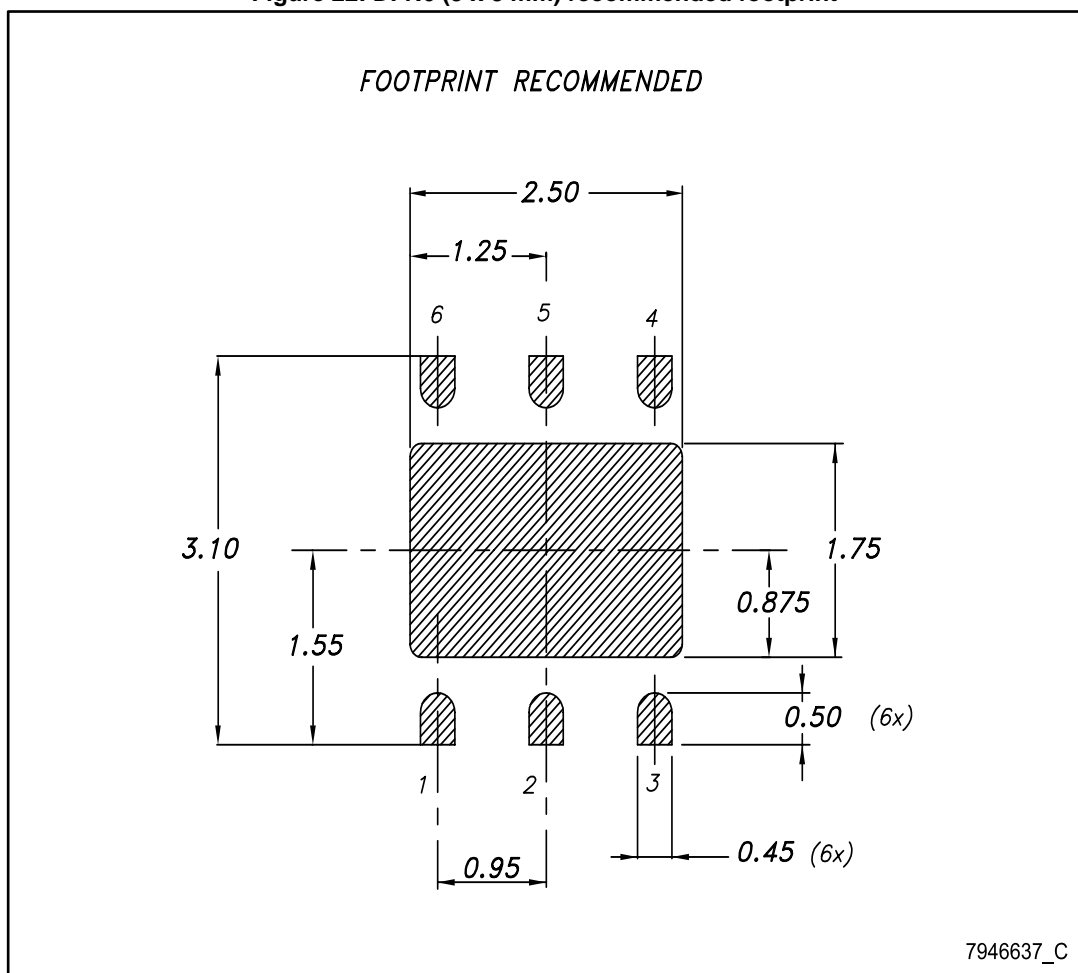



Table 9: DFN6 (3 x 3 mm) mechanical data

Dim.	mm		
	Min.	Typ.	Max.
A	0.80		1
A1	0	0.02	0.05
A3		0.20	
b	0.23		0.45
D	2.90	3	3.10
D2	2.23		2.50
E	2.90	3	3.10
E2	1.50		1.75
e		0.95	
L	0.30	0.40	0.50

Figure 22: DFN6 (3 x 3 mm) recommended footprint



### 6.4 DFN6 (3 x 3 mm) packing information

Figure 23: DFN6 (3 x 3 mm) tape outline

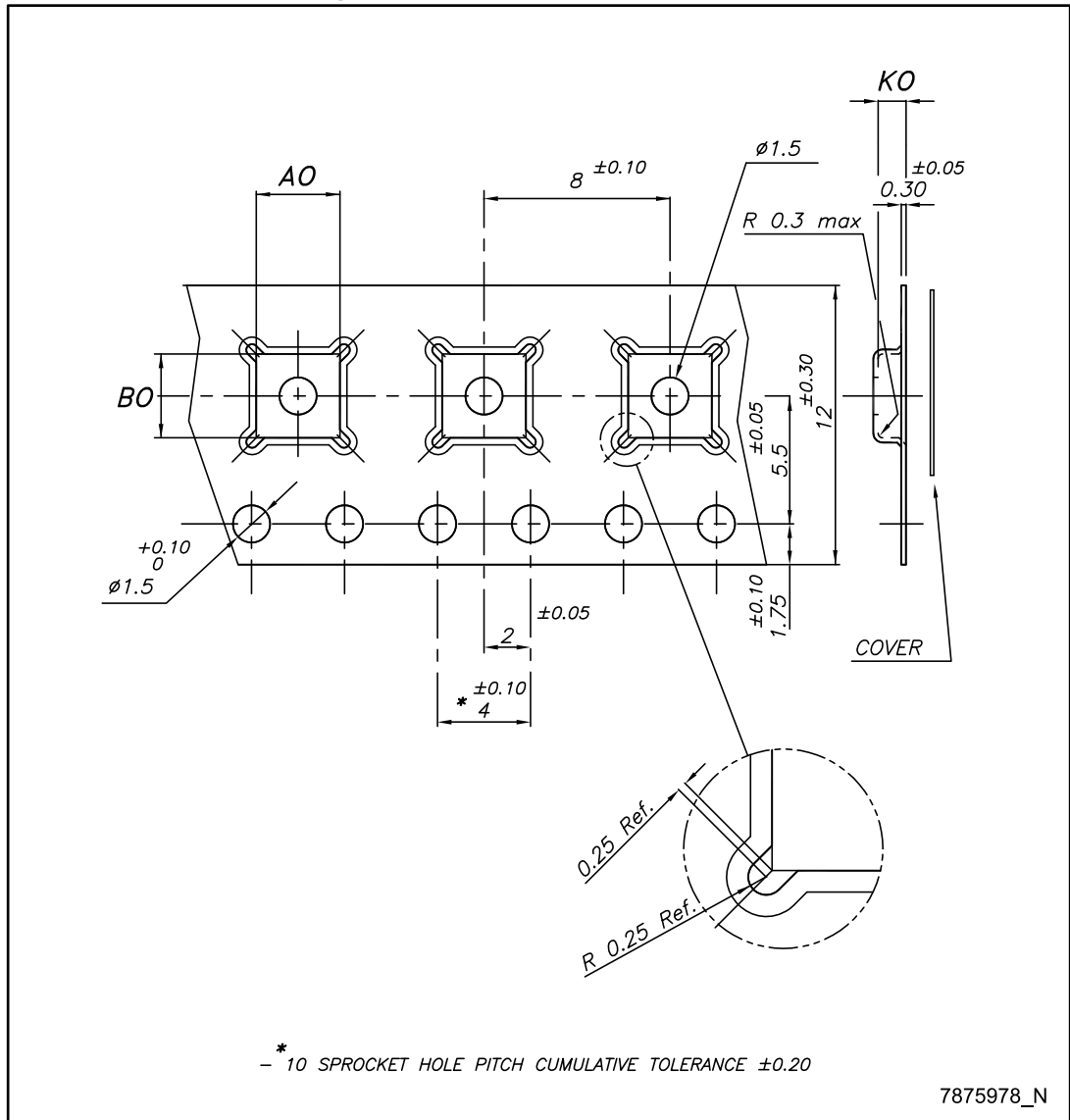

Figure 24: DFN6 (3 x 3 mm) reel outline

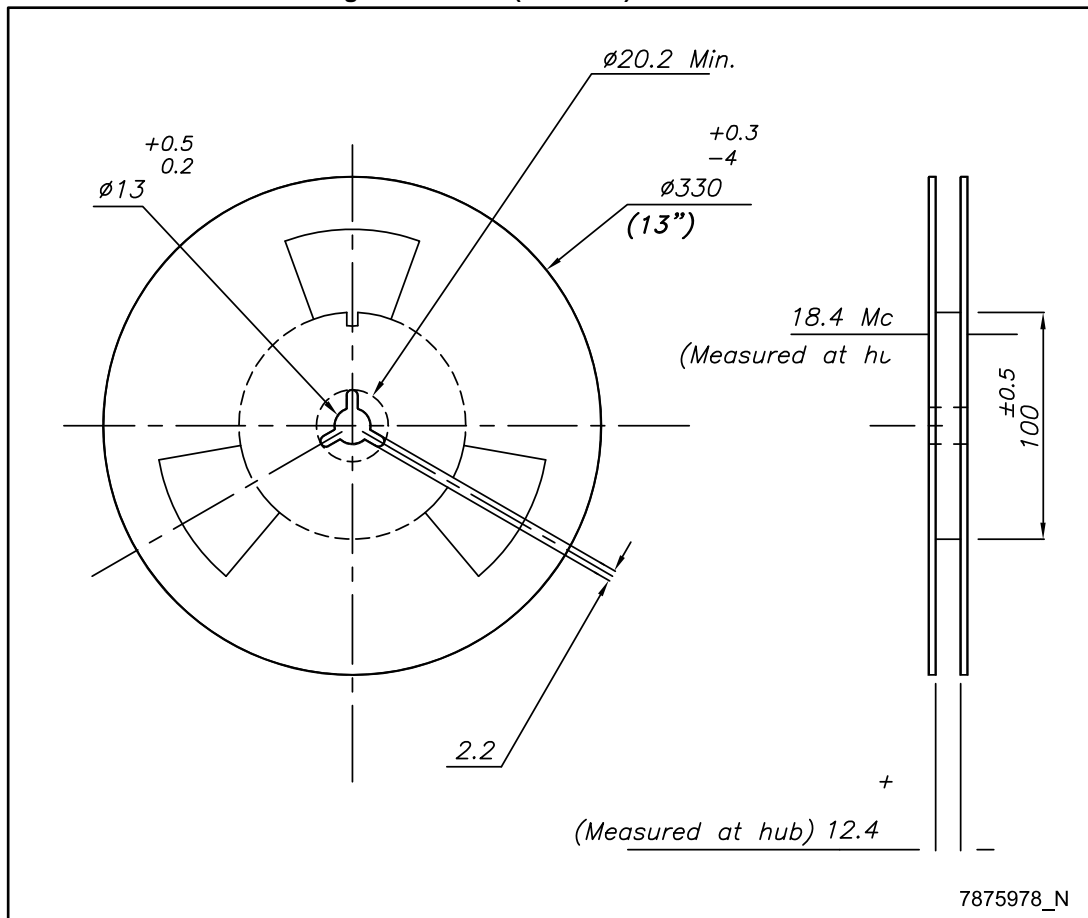

Table 10: DFN6 (3 x 3 mm) tape and reel mechanical data

Dim.	mm		
	Min.	Typ.	Max.
A0	3.20	3.30	3.40
B0	3.20	3.30	3.40
K0	1	1.10	1.20

## 7 Revision history

**Table 11: Document revision history**

Date	Revision	Changes
02-Dec-2004	1	First release.
10-Apr-2007	2	Added: new package TSOT23-5L.
16-May-2007	3	Added: new mechanical data DFN6D and order codes updated.
06-Sep-2007	4	Added: Table 1 in cover page.
11-Jun-2008	5	Modified: not found.
11-Jul-2009	6	Modified: not found.
29-Jul-2010	7	Modified: not found and not found.
24-Oct-2013	8	Modified the Title and the Features in cover page. Deleted Table1: Device summary. Updated not found and not found. Added and not found. Minor text changes.
28-Feb-2014	9	Modified the Title and the Features in cover page. Deleted Table1: Device summary. Updated Table 10: Order codes and Section 6: Package mechanical data. Added Table 6: LDS3985 (automotive grade) electrical characteristics and Section 7: Packaging mechanical data. Minor text changes.
03-May-2017	10	Updated <a href="#">Table 1: "Device summary"</a> . Minor text changes.

**IMPORTANT NOTICE – PLEASE READ CAREFULLY**

STMicroelectronics NV and its subsidiaries ("ST") reserve the right to make changes, corrections, enhancements, modifications, and improvements to ST products and/or to this document at any time without notice. Purchasers should obtain the latest relevant information on ST products before placing orders. ST products are sold pursuant to ST's terms and conditions of sale in place at the time of order acknowledgement.

Purchasers are solely responsible for the choice, selection, and use of ST products and ST assumes no liability for application assistance or the design of Purchasers' products.

No license, express or implied, to any intellectual property right is granted by ST herein.

Resale of ST products with provisions different from the information set forth herein shall void any warranty granted by ST for such product.

ST and the ST logo are trademarks of ST. All other product or service names are the property of their respective owners.

Information in this document supersedes and replaces information previously supplied in any prior versions of this document.

© 2017 STMicroelectronics – All rights reserved